

Pilot's Guide

KLN 90B

Bendix/King®
TSO'd GPS Navigation System



AlliedSignal, Inc.
Commercial Avionics Systems
400 North Rogers Road
Olathe, Kansas 66062-1294
FAX 913-791-1302
Telephone: (913) 782-0400

006-08773-0000
Rev.1 05/97



KLN 90B PILOT'S GUIDE

006-08773-0000

for KLN 90Bs with

OPERATIONAL REVISION STATUS (ORS) 20

IMPORTANT: Special installation procedures must be followed in order for the KLN 90B to be certified for IFR use. Consult the KLN 90B Flight Manual Supplement for the operating limitations of this unit.

**For Important
Database Update
Information**

See Section 2.7

May, 1997

THIS PAGE INTENTIONALLY LEFT BLANK

TABLE OF CONTENTS

INTRODUCTION	I
PREVIEW OF OPERATION	II
CHAPTER 1 - KLN 90B SYSTEM COMPONENTS	1-1
CHAPTER 2 - DATA BASE	2-1
2.1 FUNCTIONS OF THE DATA BASE	2-1
2.2 DATA BASE COVERAGE AREAS AND CONTENTS	2-1
2.3 USE OF ICAO IDENTIFIERS	2-3
2.4 UPDATING THE DATABASE	2-3
2.4.1 Computer Updating of the Database	2-4
2.4.2 Cartridge Exchange Updating of the Database	2-7
2.5 USER DEFINED DATABASE	2-8
2.6 INTERNAL MEMORY BACKUP BATTERY	2-8
2.7 DATABASE UPDATE SERVICE OPTIONS	2-8
CHAPTER 3 - LEVEL 1 OPERATION	3-1
3.1 COVERAGE AREA	3-1
3.2 TURN-ON AND SELF TEST	3-3
3.3 DISPLAY FORMAT	3-9
3.4 BASIC OPERATION OF PANEL CONTROLS	3-11
3.4.1 Page Selection	3-12
3.4.2 Data Entry	3-14
3.4.3 Alternative Waypoint Data Entry Method	3-15
3.4.4 The Duplicate Waypoint Page	3-15
3.5 MESSAGE PAGE	3-16
3.6 INITIALIZATION AND TIME TO FIRST FIX	3-17
3.7 SELECTING WAYPOINTS	3-20
3.7.1 Selecting Waypoints By Identifier	3-20
3.7.2 Selecting Waypoints By Scanning	3-21
3.7.3 "Nearest" And "Complete" Waypoint Scan Lists	3-22
3.7.3.1 Nearest Airports In An Emergency	3-23
3.7.3.2 Continuous Display Of Nearest Airport	3-24
3.7.4 Selecting Waypoint By Name Or City	3-24
3.8 DIRECT TO OPERATION	3-27
3.8.1 Direct To-Procedure 1	3-28
3.8.2 Direct To-Procedure 2	3-28
3.8.3 To Recenter The D-Bar	3-29
3.8.4 To Proceed Direct To Another Waypoint	3-29
3.8.5 Cancelling Direct To Operation	3-29
3.8.6 Waypoint Alerting For Direct To Operation	3-29
3.9 THE NAVIGATION PAGES	3-31
3.9.1 The Navigation 1 Page (NAV 1)	3-31
3.9.2 The Super NAV 1 Page	3-32
3.9.3 The Navigation 2 Page (NAV 2)	3-32
3.9.4 The Navigation 3 Page (NAV 3)	3-32
3.9.5 The Navigation 4 Page (NAV 4)	3-34
3.9.6 The Navigation 5 Page (NAV 5)	3-34
3.9.7 The Super NAV 5 Page	3-36
3.10 SPECIAL USE AIRSPACE ALERT	3-39

3.11 VIEWING THE WAYPOINT PAGES	3-42
3.11.1 Airport Pages	3-42
3.11.2 The Airport 1 Page (APT 1)	3-42
3.11.3 The Airport 2 Page (APT 2)	3-43
3.11.4 The Airport 3 Page (APT 3)	3-43
3.11.5 The Airport 4 Page (APT 4)	3-45
3.11.6 The Airport 5 Page (APT 5)	3-47
3.11.7 The Airport 6 Page (APT 6)	3-48
3.11.8 The Airport 7 Page (APT 7)	3-49
3.11.9 The Airport 8 Page (APT 8)	3-49
3.11.10 The VOR Page	3-49
3.11.11 The NDB Page	3-50
3.11.12 The Intersection Page (INT)	3-50
3.11.13 The Supplemental Waypoint Page (SUP)	3-51
3.12 FREQUENCIES FOR NEAREST FLIGHT SERVICE STATIONS	3-52
3.13 FREQUENCIES FOR AIR ROUTE TRAFFIC CONTROL CENTERS (ARTCC)	3-52
3.14 VIEWING AND SETTING THE DATE AND TIME	3-53
3.15 ALTITUDE ALERTING	3-55
3.16 HEIGHT ABOVE AIRPORT ALERT	3-58
3.17 REMOTE MOUNTED ANNUNCIATORS	3-59
3.18 SAMPLE TRIP	3-60
3.18.1 Pre-Departure	3-60
3.18.2 Enroute	3-60
3.18.3 Terminal Area	3-61
CHAPTER 4 - LEVEL 2 OPERATION	4-1
4.1 CREATING AND MODIFYING FLIGHT PLANS	4-1
4.1.1 Creating A Flight Plan	4-2
4.1.2 Activating A Numbered Flight Plan	4-3
4.1.3 Adding A Waypoint To A Flight Plan	4-4
4.1.4 Deleting A Waypoint From A Flight Plan	4-5
4.1.5 Deleting Flight Plans	4-5
4.1.6 Storing FPL 0 As A Numbered Flight Plan	4-6
4.2 OPERATING FROM THE ACTIVE FLIGHT PLAN	4-7
4.2.1 General Procedures	4-7
4.2.2 Turn Anticipation And Waypoint Alerting	4-8
4.2.3 Viewing The Waypoint Pages For The Active Flight Plan Waypoints	4-10
4.2.4 Combining Direct To And Flight Plan Operation	4-10
4.2.5 The Distance/Time Pages	4-11
4.2.6 The Distance/Time 1 Page (D/T 1)	4-11
4.2.7 The Distance/Time 2 Page (D/T 2)	4-12
4.2.8 The Distance/Time 3 Page (D/T 3)	4-12
4.2.9 The Distance/Time 4 Page (D/T 4)	4-13
4.3 SAMPLE TRIP	4-15
4.3.1 Pre-Departure	4-16
4.3.2 Enroute	4-16
CHAPTER 5 - LEVEL 3 OPERATION	5-1
5.1 TRIP PLANNING	5-1
5.1.1 The Trip Planning 0 Page (TRI 0)	5-2
5.1.2 The Trip Planning 1 And Trip Planning 2 Pages (TRI 1 and TRI 2)	5-3
5.1.3 The Trip Planning 3 And Trip Planning 4 Pages (TRI 3 and TRI 4)	5-5

5.1.4 The Trip Planning 5 And Trip Planning 6 Pages (TRI 5 and TRI 6)	5-6
5.2 ADVISORY VNAV OPERATION	5-7
5.2.1 VNAV For Direct To Operation	5-7
5.2.2 VNAV For Flight Plan Operation	5-9
5.2.3 VNAV From the Super NAV 5 Page	5-9
5.3 CALCULATOR PAGES	5-10
5.3.1 The Calculator 1 Page (CAL 1)	5-10
5.3.2 The Calculator 2 Page (CAL 2)	5-11
5.3.3 The Calculator 3 Page (CAL 3)	5-12
5.3.4 The Calculator 4 Page (CAL 4)	5-12
5.3.5 The Calculator 5 Page (CAL 5)	5-13
5.3.6 The Calculator 6 Page (CAL 6)	5-14
5.3.7 The Calculator 7 Page (CAL 7)	5-15
5.4 USER-DEFINED WAYPOINTS	5-16
5.4.1 Creating An Airport User Waypoint	5-16
5.4.2 Creating A VOR User Waypoint	5-18
5.4.3 Creating An NDB User Waypoint	5-18
5.4.4 Creating Intersection Or Supplemental User Waypoints	5-18
5.4.5 Deleting User-Defined Waypoints	5-20
5.5 REFERENCE WAYPOINTS	5-21
5.6 CENTER WAYPOINTS	5-25
5.6.1 Creating Center Waypoints And Inserting Them in Flight Plans	5-25
5.6.2 Viewing the Center Waypoints After Insertion Into A Flight Plan	5-26
5.6.3 Creating Center Waypoints After Modifying A Flight Plan	5-27
5.7 PROGRAMMING THE TURN-ON PAGE	5-28
5.8 THE STATUS PAGES	5-29
5.8.1 Determining The Status Of The GPS Signals	5-29
5.8.2 Determining KLN 90B Software Status And Operational Time	5-31
5.9 MODES OF OPERATION	5-32
5.9.1 Selecting The Leg Mode Or The OBS Mode	5-32
5.9.2 The Leg Mode	5-33
5.9.3 The OBS Mode	5-34
5.9.4 Switching From The Leg Mode To The OBS Mode	5-36
5.9.5 Switching From The OBS Mode To The Leg Mode	5-36
5.9.6 Going Direct-To A Waypoint While in the OBS Mode	5-37
5.9.7 Activating A Waypoint While In The OBS Mode	5-37
5.9.8 Changing the CDI Scale Factor	5-37
5.10 THE FUEL MANAGEMENT PAGES	5-39
5.10.1 The Other 5 Page (OTH 5)	5-39
5.10.2 The Other 6 Page (OTH 6)	5-41
5.10.3 The Other 7 Page (OTH 7)	5-41
5.10.4 The Other 8 Page (OTH 8)	5-41
5.11 THE AIR DATA PAGES	5-42
5.11.1 The Other 9 Page (OTH 9)	5-43
5.11.2 The Other 10 Page (OTH 10)	5-43
5.12 OPERATION OUTSIDE THE PRIMARY COVERAGE AREA	5-44
5.13 OPERATION WITHOUT A DATA BASE CARTRIDGE	5-44
5.14 USING THE TAKE-HOME MODE	5-46

CHAPTER 6 - LEVEL 4 OPERATION	6-1
6.1 NON-PRECISION APPROACH OPERATIONS	6-1
6.1.1 Selecting An Approach	6-4
6.1.2 Interpreting What You See	6-5
6.1.3 Changing or Deleting An Approach Once Loaded Into The Flight Plan	6-7
6.1.4 Example Approach: No Procedure Turn	6-8
6.1.5 Example Approach: Off-Airport Navaid	6-10
6.1.6 Example Approach: Radar Vectors	6-12
6.1.7 Example Approach: On-Airport Navaid	6-14
6.1.8 Example Approach: DME Arc	6-16
6.1.9 Approach Problems	6-19
6.2 SID/STAR PROCEDURES	6-21
6.2.1 Selecting A SID	6-21
6.2.2 Selecting A STAR	6-22
6.2.3 Editing a SID or STAR	6-23
6.2.4 Example of a SID Procedure	6-25
6.2.5 Example of a STAR Procedure	6-26
APPENDIX A - NAVIGATIONAL TERMS	A-1
APPENDIX B - MESSAGE PAGE MESSAGES	B-1
APPENDIX C - STATUS LINE MESSAGES	C-1
APPENDIX D - ABBREVIATIONS	D-1
APPENDIX E - SECONDS TO DECIMAL MINUTES	E-1

INTRODUCTION

The KLN 90B is an extremely sophisticated navigational device, capable of providing highly accurate navigation over most parts of the world. You will be amazed at all of the navigational and other aeronautical functions that the unit can perform. However, you don't need to master all of the KLN 90B's capabilities at once. In just a short time you will be confidently using it to make your flying duties easier and more enjoyable. You will learn new features as you have a need or desire to learn them and soon will establish the best way of using the KLN 90B to meet your particular flying requirements.

Don't let the size of this Pilot's Guide intimidate you! It is written in plain, simple English instead of "computer-eeze" and it assumes you are not an experienced user of GPS or other types of long range navigation equipment. If you are experienced, so much the better. This Pilot's Guide also includes hundreds of sample screen figures and other illustrations to make your learning easier. It is designed so that you can start at the front and progress in the order presented; however, you may want to skip around and learn things in your own order. There are several appendices in the back that you may find useful from time to time.

As you become proficient with using the KLN 90B, don't be tempted to rely on it as the sole means of navigation. A good pilot never relies on just one source of navigation for either VFR or IFR flying. Cross check your position using VOR, DME, ADF, or other navigational devices you may have in the cockpit - including your eyes!

Be sure and keep a copy of this Pilot's Guide in the aircraft to use as a reference. You never know when you may have a question you'll want to look up.

One last thing. Don't get so involved in learning to use the KLN 90B that you forget to fly the aircraft. Be careful, and remember to keep a close eye out for other aircraft.

NOTE: A white border is used around data on some of the figures in this Pilot's Guide to indicate that the data inside the border is flashing. An example of this is figure 3-5 where the white border around the characters **ACKNOWLEDGE?** and **ENT** is used to indicate that both are flashing.

PREVIEW OF OPERATION

No doubt you are going to read this entire manual just as soon as you possibly can. But just to get an idea of how easy the KLN 90B is to operate, the following operational preview is presented. This operational preview assumes the KLN 90B has been properly installed, the unit was previously operational in the same general geographical location, and that no peripheral equipment interfaced with the KLN 90B (such as external HSIs, CDIs, autopilots, RMI, fuel flow systems, moving map display, etc.) is to be used at this time. If you are using this operational preview in flight, do so only in good VFR conditions and only with an alternate means of navigation available to cross-check position.

1. Push the power/brightness knob located in the upper right corner of the unit to the "in" position.
2. After a few seconds of warm up, the screen will show a Turn-On page with the words **SELF TEST IN PROGRESS** at the bottom of the page. Rotate the power/brightness knob to select the desired screen brightness. After a few seconds the Turn-On page will automatically be replaced with the Self Test page. (Note: If the KLN 90B is being used in the take-home mode, a Take-Home Warning page is displayed before the Self Test page and must be acknowledged by pressing **■**.) The Self Test page is recognizable because it shows the date and time on the right side. If the date and time are incorrect by more than 10 minutes, refer to section 3.2 of this manual. The bottom left side of the Self Test page must display **ANNUN ON** to indicate that the KLN 90B has passed an internal self test.

In most KLN 90B installations the first two characters of the altimeter setting **BARO** field will be highlighted in inverse video (dark characters on a light background) on the right side of the screen. This area of inverse video is called the cursor. Use the right inner knob to select the correct first two characters of the altimeter setting. Next, turn the right outer knob one step clockwise to position the cursor over the third character of the altimeter setting. Use the right inner knob to select the correct number. Once again turn the right outer knob one step clockwise to position the cursor over the last character of the altimeter setting. Use the right inner knob to complete entering the correct altimeter setting.

Turn the right outer knob clockwise to position the cursor over the word **APPROVE?** if the cursor is not there already. Press **■** to approve the Self

Test page. (Note: If the KLN 90B is installed for VFR only operation, a VFR only warning page is displayed after the self test page has been approved. This warning page must be acknowledged by pressing **■**.)

3. A Database page is now displayed showing the date the data base expires or the date it expired. Press **■** to acknowledge the information displayed on this page.
4. A page displaying the letters **PRESENT POS** at the top will now be on the left side of the screen. In a couple minutes or less, this page will display the aircraft's present position. It shows the position both in latitude/longitude and in terms of the radial and distance from a nearby VOR. Verify that the position is correct before proceeding.
5. Press the **■** button. A page with the words **DIRECT TO** is now displayed on the left.

In step 6 you will enter the ICAO identifier of the destination airport. The identifier will have a "K" prefix for a Continental U.S. airport, a "C" prefix for a Canadian airport, or a "P" prefix (in many cases) for an Alaskan airport if the identifier is all letters. For example, LAX becomes KLAX. For these countries if the identifier contains any numbers, there is no prefix. For example, TX04 is entered TX04. For other areas of the world the airport identifier entered should be identical to how it is charted.

6. Rotate the left inner knob until the first character of the airport identifier is displayed. Turn the left outer knob one step clockwise to move the flashing segment to the second character position. Rotate the left inner knob to select the second character of the identifier. Use this procedure to enter the complete airport identifier.
7. Press **■**. The right side will display a page showing the identifier, name and position of the airport just entered. Confirm that the correct airport is displayed. Press **■** a second time to approve the airport data.
8. A Navigation page is now on the right side of the screen. It displays the distance, ETE, and bearing to the destination airport. In addition, it displays groundspeed and a course deviation indicator. If the left inner knob is rotated one step counter-clockwise, you will get an enlarged Navigation page occupying the entire screen.

CHAPTER 1 - KLN 90B SYSTEM COMPONENTS

A basic KLN 90B system consists of a panel mounted KLN 90B GPS sensor/navigation computer, a data base cartridge, and an antenna. An altitude input is required to obtain full navigation and operational capabilities. Additional system components may be added or interfaced to the KLN 90B which increase its features and

capabilities. Some of these optional components include an external course deviation indicator (CDI) or HSI, RMI, fuel management system, air data system, ARTEX ELS-10 emergency locator transmitter (ELT), autopilot, and external annunciators.

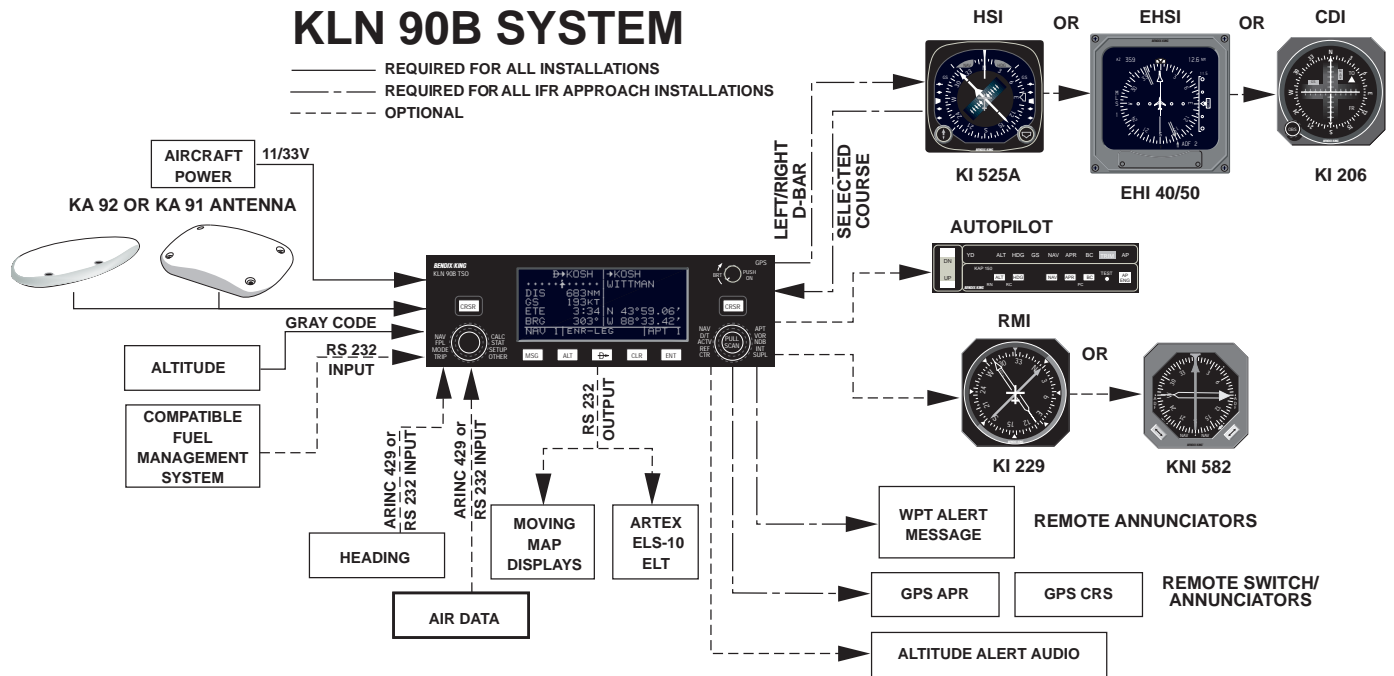

The KLN 90B panel mounted unit contains the GPS sensor, the navigation computer, a CRT display, and all controls required to operate the unit. It also houses the data base cartridge which plugs directly into the back of the unit.

The database cartridge is an electronic memory containing a vast amount of information on airports, nav aids, intersections, special use airspace, and other items of value to the pilot. The database is designed to be easily updated by the user by using a laptop computer and AlliedSignal furnished 3.5 inch diskettes. The database may also be updated by removing the obsolete cartridge and replacing it with a current one.

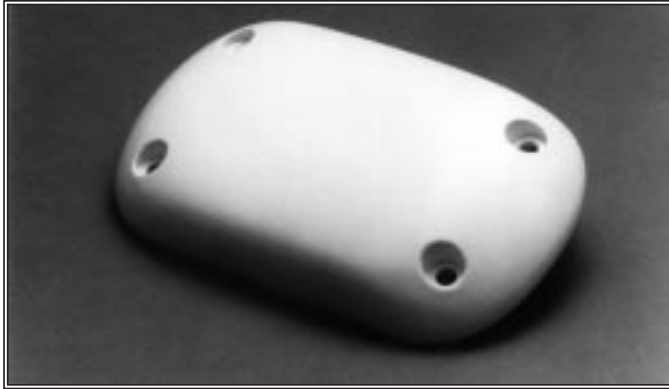

KA 91 GPS Antenna

Two GPS antennas can be used with the KLN 90B. One is the KA91 and the other is the KA 92. The KA 92 is used with new production KLN 90Bs and the KA 91 is used with units that have been upgraded from either a KLN 90 or a KLN 90A. They are “patch” antennas designed to always be mounted on the top of the aircraft.

The KLN 90B has analog outputs to drive the left-right deviation bar of most mechanical CDIs and HSIs. In addition, it has digital outputs to automatically drive the course pointer and display flight plan waypoints on the Bendix/King EHI 40 and EHI 50 electronic HSIs.

The Bendix/King KI 229 and KNI 582 RMIs may be interfaced to the KLN 90B to provide a display of magnetic bearing to the waypoint.

The NAV mode of the Bendix/King KFC 150, KAP 150, KAP 150H, KAP 100, KFC 200, KAP 200, KFC 250, KFC 275, KFC 300, KFC 325, KFC 400 and KFC 500 Flight Control Systems may be coupled to the KLN 90B. Many other autopilots may also be coupled to the KLN 90B. Actual autopilot performance and capability when coupled to the KLN 90B may vary significantly from one autopilot model to another.

Certain Digiflo™ and Miniflo™ fuel management systems manufactured by Shadin Co. Inc. as well as certain fuel computers manufactured by ARNAV Systems, Inc. and SHELTECH LTD interface with the KLN 90B. These interfaces allow the pilot to view fuel related parameters calculated by the KLN 90B such as how much fuel will be remaining when the aircraft lands at the destination. With certain Shadin fuel management systems it is possible to update the fuel on board through the KLN 90B. In these cases a separate panel mounted interface to the fuel management computer is not required.

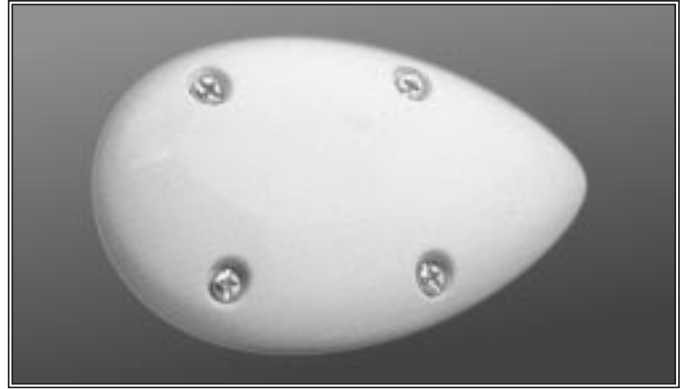

KA 92 GPS Antenna

Compatible air data systems are available from Bendix/King and Shadin Co. An air data system is capable of providing the KLN 90B with true air speed data which is used for wind determination. The Shadin air data system also will convert heading data from the Bendix/King KCS 55A and some other compass systems to a format that allows wind calculations to be fully automatic.

Altitude may be provided to the KLN 90B from an encoding altimeter, blind encoder, or one of the air data computers mentioned above. Altitude is used as an aid in position determination when not enough satellites are in view. Altitude is also used in several altitude related features such as three dimensional special use airspace alerting, height above airport, and altitude alerting.

Some installations may require remote annunciators to be mounted in the aircraft panel in order to indicate the status of certain KLN 90B functions. Specifically, the KLN 90B has outputs to provide annunciation for waypoint alert and message.

In installations where the KLN 90B will be used for approaches, the installations are more complicated. External switches and annunciators are required to change approach modes as well as how the KLN 90B defines the course to the active waypoint. Selected course is generally required to be provided to the KLN 90B through an HSI, CDI or EFIS.

CHAPTER 2 - DATABASE

One reason the KLN 90B is such a powerful navigation system is because of its extensive database. A database is an area of electronic memory used to store a large catalog of navigational and aeronautical information.

2.1 FUNCTIONS OF THE DATABASE

The database provides two primary functions. First, it makes pilot interface with the GPS sensor much easier. Rather than having to manually look up and then enter the latitude and longitude for a specific waypoint, it allows you to merely enter a simple waypoint identifier. The database automatically looks up and displays the latitude and longitude associated with the identifier. It's obvious that the database saves a lot of tedious latitude/longitude entry and also greatly reduces the potential for data input mistakes.

The second function of the database is that it serves as a very convenient means to store and easily access a vast amount of aeronautical information. Want to know the tower frequency or the length of the runways at a specific airport? No need to look them up in a book - just turn a couple knobs and display the information right on the KLN 90B.

2.2 DATABASE COVERAGE AREAS AND CONTENTS

The International Civil Aviation Organization (ICAO) and Aeronautical Radio, Inc. (ARINC) break the world into the ten geographic regions shown in figure 2-1. The databases for the KLN 90B have a primary and a secondary coverage area. The primary coverage areas are indicated in figure 2-1 and contain more detailed information. The secondary area contains less detailed information for the rest of the world.

Specifically, all databases contain complete information for all worldwide VORs, NDBs, and minimum safe altitudes (MSAs). For its primary area, the database contains public use and military airports which have any runway at least 1000 feet in length. For its secondary area, the database also contains airports having a hard surface runway at least 3000 feet in length. Airport communication frequencies and runway information are provided

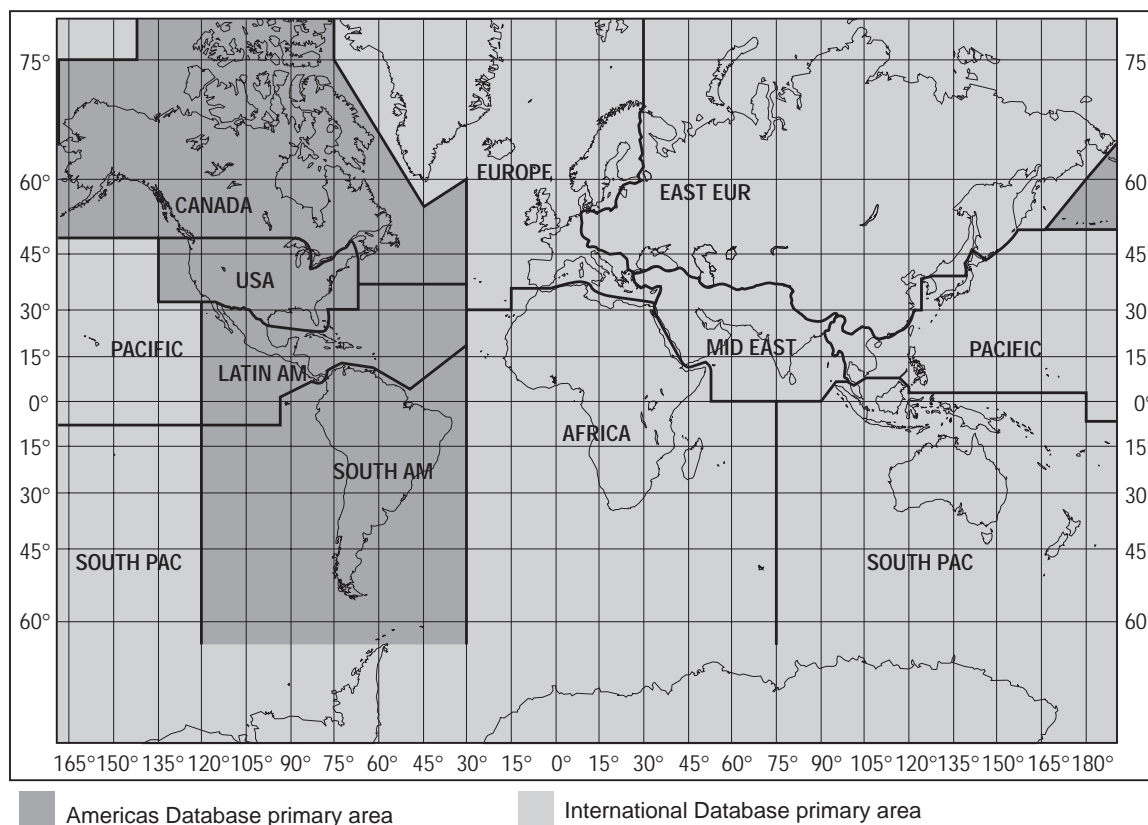

Figure 2-1. KLN 90B Database Geographical Regions

only for airports in the primary area of the database. Intersections, air route traffic control center data, flight service station frequencies, and special use airspace are also provided only for the primary area.

The following is a list of the KLN 90B database contents:

*AIRPORTS

- Identifier
- Name
- City, State or Country
- Type (public or military)
- Latitude and Longitude
- Elevation
- Approach indicator for precision, non-precision or no instrument approach at airport
- Radar approach/departure environment indicator
- Whether airport underlies CL B, TRSA, CL C, CTA, or TMA
- Time relative to UTC (Zulu)
- Communication frequencies (VHF and HF):
 - ATIS
 - Clearance delivery
 - Tower
 - Ground control
 - Unicom
 - Multicom
 - Approach (IFR)
 - Departure (IFR)
 - Class B, Class C, TRSA, CTA, TMA (VFR)
 - Center (when used for approach)
 - Arrival
 - Radar
 - Director
 - Radio
 - AWOS (automatic weather observing station)
 - AAS (aeronautical advisory service)
 - ATF (Aerodrome traffic frequency)
 - CTAF (common traffic advisory frequency)
 - MF (mandatory frequency)
 - Ramp control
 - PCL (pilot-controlled lights)
- Runway data (designation, length, surface, lighting, traffic pattern direction)
- Airport Services (fuel, oxygen, customs, indicator for presence of a landing fee)
- Airport Comments (user may manually enter remarks of up to 33 characters at any 100 airports in database)

VORs

- Identifier
- Name
- Frequency
- DME indicator
- Class (high altitude, low altitude, terminal, undefined)
- Latitude and Longitude
- Magnetic variation

NDBs

- Identifier
 - Name
 - Frequency
 - Latitude and Longitude
- (Note - Outer Compass Locators are stored as Intersections)

*INTERSECTIONS (low altitude, high altitude, SID/STAR, approach, and outer markers)

- Identifier
- Latitude and Longitude

*SID/STAR/Approach Procedures

- All compatible pilot-nav SID/STAR procedures
- Non-precision approaches (except localizer, LDA (Localizer Directional Aid), SDF (Simplified Directional Facility)) approved for overlay use. Includes all public GPS only approaches.

MISCELLANEOUS

- *Air Route Traffic Control Center (ARTCCs and FIRs) boundaries and frequencies (VHF and HF)
- *Flight Service Stations (Location of points of communication and associated frequencies - VHF and HF)
- Minimum Safe Altitudes
- *Special Use Airspace boundaries (Prohibited, Restricted, Warning, Alert, MOA, Class B, TRSA, Class C, CTA, TMA)

250 USER DEFINED WAYPOINTS

- Identifier
- Latitude and Longitude
- Additional data depending on how user defines waypoint:
 - User airports (elevation and surface of longest runway)
 - User VOR (frequency and magnetic variation)
 - User NDB (frequency)

And you think your telephone directory has a lot of information!

* Items indicated with asterisk are included in the primary database coverage area, but not in secondary coverage area. The exception is that airports in primary coverage area include those public and military bases having a runway at least 1000 feet in length. Airports in secondary coverage area are those having a hard surface runway at least 3000 feet in length.

2.3 USE OF ICAO IDENTIFIERS

Waypoints are stored in the KLN 90B database almost exclusively by their ICAO identifiers. ICAO is an internationally accepted reference for the data. In almost all cases the proper ICAO identifiers may be taken directly from Jeppesen Sanderson or government aeronautical charts. For example, Dallas and Los Angeles VORs have the familiar ICAO identifiers DFW and LAX, respectively.

Please note that one area of potential confusion is airport identifiers in the Continental United States, Alaska, and Canada. Many airport identifiers in the database have four letters beginning with a prefix letter that corresponds to the geographic area in which it is located. The prefix letter for the Continental United States is "K". Thus, the identifier for Dallas/Fort Worth International airport is KDFW, not DFW. This distinguishes the airport identifier from the VOR identifier. Likewise, the identifier for Los Angeles International airport is KLAX while the VOR identifier is LAX. The prefix letter for Alaska is "P" and for Canada is "C".

NOTE: *There are several exceptions in Alaska. In many cases, airports with three letter identifiers receive the prefix "P", but there are many that don't. The most reliable method of determining an Alaska airport identifier is to look it up from the airport name or city. See [section 3.7.4](#), "Selecting Waypoints by Name or City".*

Not all airport identifiers receive the prefix letter. Airport identifiers which are combinations of letters and numbers do not receive the prefix letter. Examples of airport identifiers not using the prefix are 3C2, 7TX6, and M33.

So remember, if you are entering or looking for an airport identifier that is all letters (no numbers) then it will begin with a "K" prefix in the Continental U.S., a "P" in Alaska, or a "C" in Canada. If there are numbers in the identifier then a prefix is not used. For other areas of the world the airport identifier stored in the KLN 90B database is identical to how it is charted.

2.4 UPDATING THE DATABASE

The information stored in the database would eventually become obsolete if there wasn't some means to update it. For example, nav aids can move or change frequency, new runways can be added to an airport, communication frequencies can change, and on and on.

The database is housed in a cartridge which plugs directly into the back of the KLN 90B. It is designed so that there are two ways for the user to easily keep the database current. The first is to electronically update the database by means of 3.5" diskettes supplied by AlliedSignal and a laptop computer. This method does not involve removing the KLN 90B from the aircraft's instrument panel. A jack, usually mounted in the aircraft's instrument panel, provides a means of interfacing the KLN 90B with the computer via an interface cable. The diskettes are not returned to AlliedSignal.

The second method of database update is to remove the old cartridge and insert a current cartridge. This method involves returning the old cartridge to AlliedSignal.

Every 28 days, AlliedSignal receives new NavData™ information from Jeppesen Sanderson. This information is processed and downloaded onto both diskettes and database cartridges. AlliedSignal makes these two types of update services available to you in a choice of several subscription or random update programs. See [section 2.7](#) of this manual for details on these programs.

Regardless of whether the computer method or the cartridge exchange method of database updating is used, AlliedSignal sends the update so that it arrives prior to the next effective date. The new update may be installed any time prior to the effective date and the KLN 90B will use the previous data up to the effective date and automatically begin using the new data on the effective date.

In order to get maximum utilization from the KLN 90B, AlliedSignal highly encourages you to update the database on a frequent basis, if not every 28 days. It is also a matter of safety to not fly with out of date information.

WARNING: The accuracy of the database information is only assured if it is used before the end of the effectivity period. Use of out of date database information is done entirely at the user's own risk.

2.4.1 Computer Updating Of The Database

Update information is sent to you on several 3.5" disks. In order to use this update method you must have access to an IBM compatible computer having a disk drive capable of using and booting (loading) from 3.5" 1.44 megabyte high density disks. This computer also needs to have an available COM 1 or COM 2 serial port. In addition, an optional PC Interface kit must be used. Included in the kit are a data loader jack (wired to the KLN 90B and usually installed in the aircraft's instrument panel) and an interface cable that plugs into both the computer and into the data loader jack.

CAUTION: The database must be updated only while the aircraft is on the ground. The KLN 90B does not perform any navigation functions while the database is being updated. Since a database update takes approximately 10 minutes it is a good idea to turn off all electrical equipment on the aircraft except for the KLN 90B to avoid running down the aircraft battery.

NOTE: *The disks sent to you can only be used to update one KLN 90B, although they can update this specific unit numerous times. The first time the disks are used in an update operation, a unique identification code from the KLN 90B being used is uploaded to the disks. These disks may be used in this specific KLN 90B an unlimited number of times which could be required if you switch back and forth between the North American and International data bases during one update cycle. These disks may not, however, be used to update other KLN 90Bs. This update protection ensures that Jeppesen Sanderson is properly compensated for the use of their NavData™.*

Follow these steps to update the KLN 90B:

1. Plug the 9 pin female connector end of the interface cable into a COM serial port of the computer. If the computer has COM 1 and COM 2 serial ports, either may be used. Some computers use a 9 pin COM serial port connector while other computers use a 25 pin connector. If the computer being used has a 9 pin connector, the interface cable connector will plug directly into the computer's 9 pin connector. If the computer's COM serial port uses a 25 pin connector, use the 25 pin to 9 pin adapter included in the PC interface kit to adapt the interface cable's connector to the computer's connector.
2. Plug the other end of the interface cable (4 conductor male plug) into the data loader jack that is mounted in the aircraft.

3. Turn on the computer being used for the database update. Insert Disk 1 into the computer's disk drive. There can be either 2 or 3 disks used for the update so be sure the label on the outside of the disk says "Disk 1 of 2" or "Disk 1 of 3". The program on the disk will automatically "boot" (load) and the computer screen will display "Ready" when the computer is ready to continue with the database update operation.

4. Turn on the KLN 90B. Press **■** as required to approve the Self Test and Database pages. Use the left outer knob to select the Setup (SET) type pages and the left inner knob to select the SET 0 page (figure 2-2).

5. Press the left **■**. **UPDATE PUBLISHED DB** will now be displayed as in figure 2-3.

6. Press **■**. The database region and the expiration date of the database presently loaded in the KLN 90B is displayed (figure 2-4). If the database is out of date the word **EXPIRES** changes to **EXPIRED**.

7. Press **■** to acknowledge the information on this page and to continue the update procedure. The estimated load time in minutes is now displayed (figure 2-5).

NOTE: In steps 5, 6, and 7, repeated presses of **■** will terminate the update process and bring the display back to the original SET 0 page shown in figure 2-2.



Figure 2-2



Figure 2-3



Figure 2-4



Figure 2-5

8. Press **■** to acknowledge the estimated load time and begin erasing the existing database. The unit will now display **ERASING DATA BASE** (figure 2-6). After the database has been erased, loading of the new data begins automatically. As the new data is being loaded, the percentage of transfer is displayed (figure 2-7).



Figure 2-6

9. Monitor the computer screen. When the first disk is complete the computer screen will display "Insert Disk 2 then press any key to continue." Disk 1 should now be removed from the disk drive and disk 2 should be inserted. Press any key on the computer. The load operation will continue. If there are 3 disks the computer screen will prompt when to use disk 3.



Figure 2-7

10. The KLN 90B will indicate when the database update is complete as shown in figure 2-8. The computer screen will display the new database expiration date. You may either turn the KLN 90B off at this point or press **■** to restart the KLN 90B.



Figure 2-8

11. Remove the interface cable. Remove the disk from the computer. Turn off the computer.

The chances are small of having difficulty updating the database but if you have a problem:

First check that the interface cable is properly connected and that the computer is turned on. If there is a problem with the connection or the computer the KLN 90B will display **LOADER NOT READY**. When the problem is corrected this prompt is removed and the update operation can continue from where it left off.

If the wrong disk is inserted the computer screen will display "Incorrect Disk - please insert disk ___.", where the number 2 or 3 is inserted in the blank.

If an internal test fails after the data has been loaded, the KLN 90B will display **CHECKSUM ERROR, DATA BASE INVALID, ACKNOWLEDGE?**. Press **■** to acknowledge. The KLN 90B will then display **RETRY** and **EXIT**. Use the left outer knob to position the cursor over the desired choice and press **■**.

There are other error messages that may be displayed. If you have a problem that you can't resolve, write down any error messages to aid your Bendix/King Service Center in identifying the problem.

2.4.2 Cartridge Exchange Updating of the Database

To exchange the KLN 90B cartridge it is necessary to remove the KLN 90B from the aircraft's instrument panel. The KLN 90B and the mounting rack have been designed to provide for easy removal. Follow these steps to update the database cartridge.

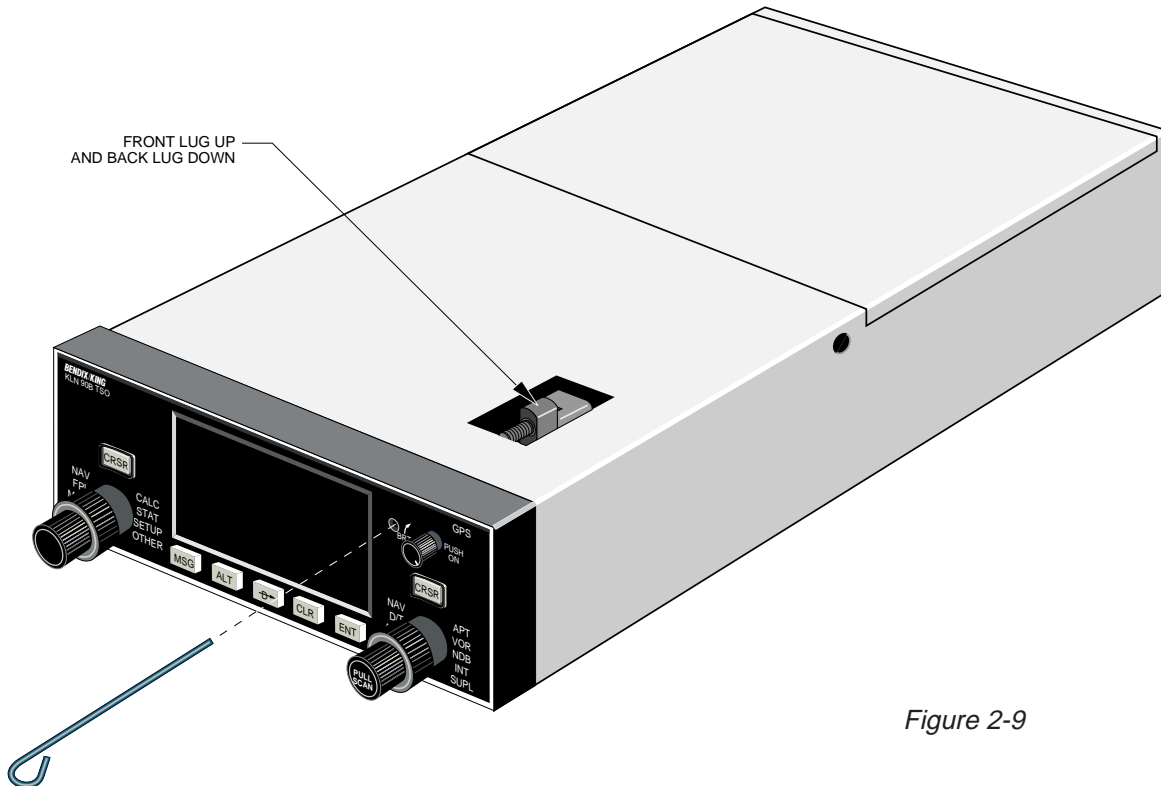

Figure 2-9

1. Insert the KLN 90B insertion/removal tool (supplied with unit) in the small hole located on the right side of the front of the unit (figure 2-9). A standard 3/32 inch Allen wrench may also be used.
2. Turn the tool counterclockwise until the locking mechanism becomes loose and then continue turning counterclockwise until it just barely begins to become snug. Do not turn so far counterclockwise that the mechanism starts to bind and can no longer be turned.
3. The KLN 90B should now be loose from the rack. Pull the unit out of the rack by pulling on the sides of the radio's front panel. DO NOT REMOVE BY PULLING ON THE KNOBS.
4. Remove the old database cartridge by pulling it straight out the back of the KLN 90B (figure 2-10).
5. Remove the new database cartridge from its shipping container. Note that the label on the cartridge indicates

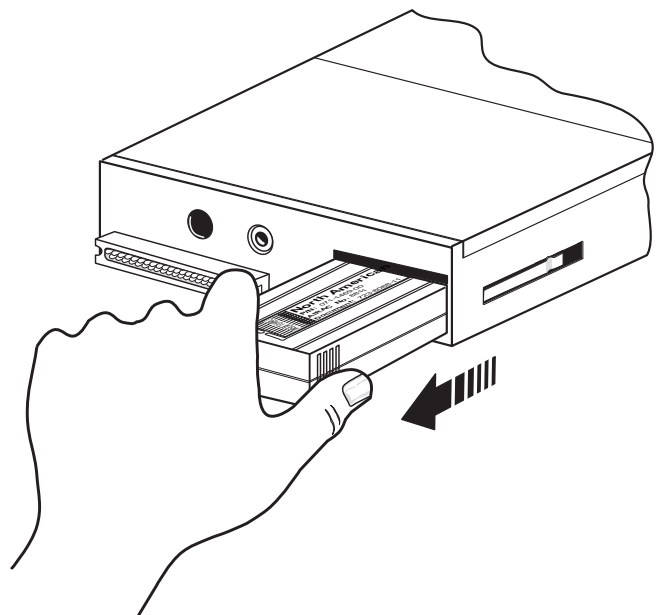

Figure 2-10

which side is up and which end to insert into the KLN 90B. Insert the new cartridge into the back of the unit. When the cartridge is properly inserted, the “Insert To Here” marking on the label can just be seen protruding from the rear of the KLN 90B (figure 2-11).

6. Make sure that the front lug of the locking mechanism is in the up position (figure 2-9). Insert the KLN 90B back in the rack as far as it will go.

7. Re-insert the insertion/removal tool. Turn the tool clockwise until snug. The KLN 90B should now be locked back into the mounting rack. Pull gently on the front panel to verify that the unit is indeed locked into its rack.

8. The container which was used to ship the new cartridge to you is used to return the old cartridge back to AlliedSignal. A return shipping label is included in the container. Remove the backing from the label and place it in the address position of the shipping container.

9. Insert the old cartridge into the container. Peel off the protective backing from the adhesive on the end flap of the container. Press the flap against the adhesive to seal the container.

10. Please return the old cartridge promptly by mailing immediately at any mailbox. No postage is required if mailed from within the U.S. Users will be billed for cartridges not returned and no additional cartridges will be sent until either the old cartridge or payment for the old cartridge is received.

2.5 USER DEFINED DATABASE

In addition to the published database of airports, VORs, NDBs, and intersections stored in the cartridge, you may create up to 250 other waypoints. These waypoints may be designated by you to be one of the four waypoint types above or as a waypoint not falling into one of these types. In the latter case the waypoint is called a Supplemental waypoint. Section 5.4 describes how you may create a user-defined waypoint.

2.6 INTERNAL MEMORY BACKUP BATTERY

The KLN 90B contains an internal lithium battery that is used to “keep-alive” the user-defined database as well as flight plans. This battery has a typical life of three to five years. *It is highly recommended that the battery be replaced every three years at an authorized Bendix/King Service Center.*

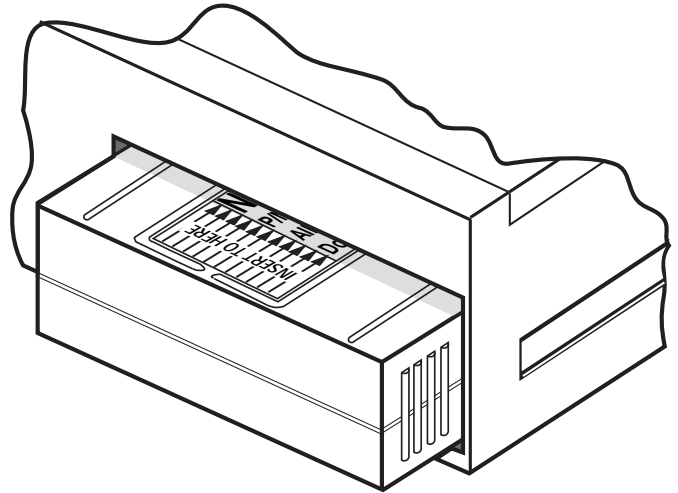

Figure 2-11

2.7 DATABASE UPDATE SERVICE OPTIONS

The following tear-out pages can be used for ordering the North American and International database update services from AlliedSignal. The forms may be mailed or faxed for your convenience.

**KLN 90B Data Base Update Service Order Form
Consult Pricing Sheet (006-08794-0001) for Service Prices**

AlliedSignal GAA offers several update service options to suit your requirements. Please select the service desired, then fill out and mail this order form. Credit card orders may be faxed.

Updates from the Internet can be obtained directly by logging onto the AlliedSignal Internet site and following the instructions

provided, or by calling the telephone number below to set up an account.

Note: Updates are current for 28 days after effective date on diskette. If you select any service other than the complete 13-time service, your KLN 90B will begin alerting you after 28 days that your data base is out of date.

Check One:

- Database Card Format**
(available in U.S./Canada only)
- Diskette Format**
(Laptop Computer Required. See section 2 of KLN 90B Pilot's Guide for details.)

Check Requested Data Base:

- Americas Data Base**
- International Data Base**

Check One:

- Complete Update Service.**
Provides 13 updates—one every 28 days for one year.
- Six-time Update Service.**
Provides six updates—one every 56 days for one year.
- Four-time Update Service.**
Provides four updates—one during each quarter for one year.
- Single Update.** Provides one update upon receipt of order.

Please set up the service under:

Name: _____
 Company: _____
 Address: _____
 City: _____
 State: _____ Zip Code: _____
 Country: _____
 Telephone: (____) _____
 FAX: (____) _____
 Aircraft Make: _____
 Aircraft Model: _____

Method of Payment

Check/Money order enclosed

Wire Transfer:
Chase Manhattan Bank, NY
Acct #910-2-538734

MasterCard/VISA

Number _____

Expires _____

Signature _____

**Tax may apply in some states.
See pricing sheet.**

Send to:

AlliedSignal CAS
 Data Base Update Service
 Mail Drop #66
 400 N. Rogers Road
 Olathe KS 66062-1212
 Telephone: (913) 768-3020
 FAX: (913) 768-3904



Tape here

Fold here

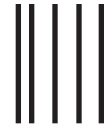

NO POSTAGE
NECESSARY
IF MAILED
IN THE
UNITED STATES

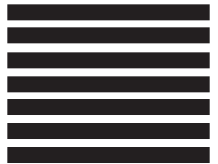

BUSINESS REPLY MAIL
FIRST-CLASS MAIL PERMIT NO. 121 OLATHE, KANSAS

POSTAGE WILL BE PAID BY ADDRESSEE

ALLIEDSIGNAL COMMERCIAL AVIONICS SYSTEMS
M D 66
400 NORTH ROGERS ROAD
OLATHE KS 66062-9987



CHAPTER 3 - LEVEL 1 OPERATION

This is the first of three chapters specifically dealing with operating the KLN 90B. In this chapter you will learn the basic operation of the front panel controls and then how

to perform Direct To navigation (navigating from your present position direct to your desired location).

3.1 COVERAGE AREA

The KLN 90B was designed to provide worldwide navigation coverage from North 74° latitude to South 60° latitude (figure 3-1). Outside this area, magnetic variation must

be manually entered as discussed in section 5.12. See section 2.2 for the database coverage areas.

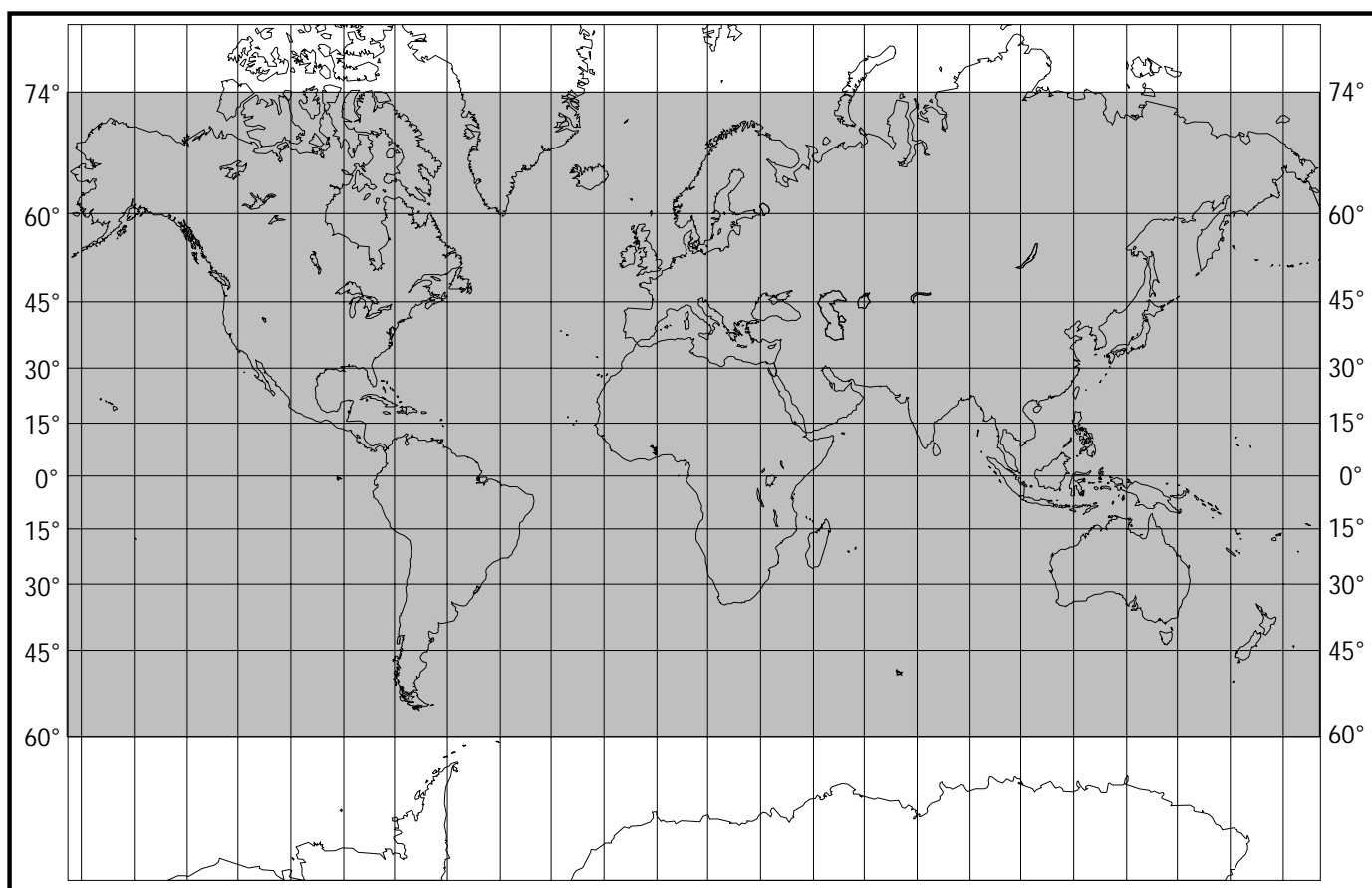

Figure 3-1 KLN 90B Navigation Coverage Area

IMPORTANT: Special installation procedures must be followed in order for the KLN 90B to be certified for IFR use. Consult the KLN 90B Flight Manual Supplement for the operating limitations of this unit.

KLN 90B CONTROLS

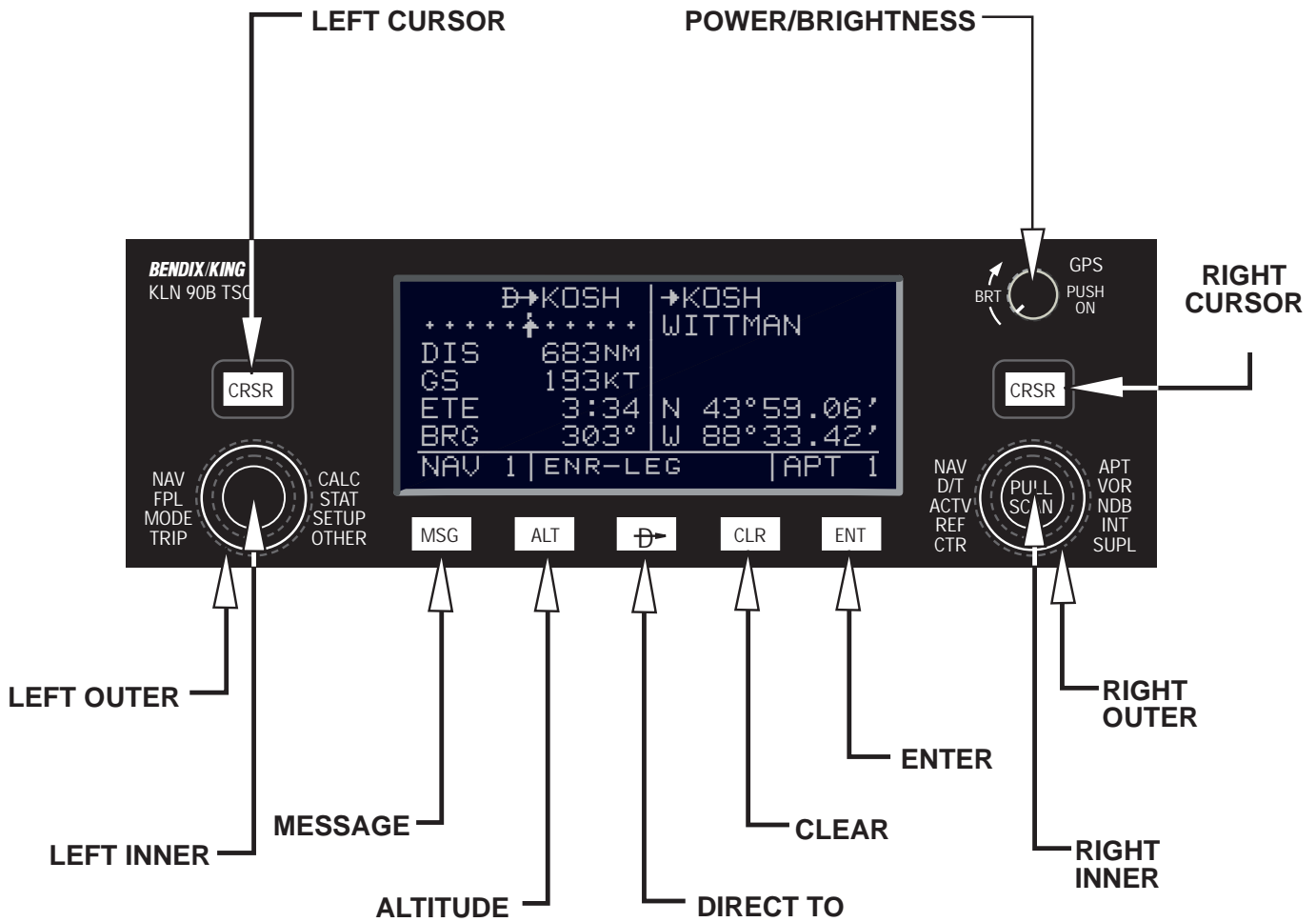

Figure 3-2

3.2 TURN-ON AND SELF TEST

Enough of the preliminaries. Let's get started into actually turning the KLN 90B on and using it! Figure 3-2 will fold out and allow you to use it as a reference as you read this chapter, especially if you don't have a KLN 90B immediately at hand. The steps below take a lot of words to explain, but you will find that in actual use you will accomplish these steps in just a few moments.

NOTE: When power is applied to the KLN 90B it always "wakes up" in the Enroute-Leg mode. Only the Enroute-Leg mode is described in this chapter. In this mode the KLN 90B performs great circle navigation (the shortest distance between two points located on the earth's surface). The course deviation output displayed on the unit's internal course deviation indicator (CDI) and provided to an external HSI or CDI is five nautical miles left and right, full scale sensitivity. The other modes of the unit are described in section 5.9 and in chapter 6.

1. Turn-on the KLN 90B by pressing the power/brightness knob to the "in" position. The power/brightness knob is located on the upper right side of the unit. It takes just a few seconds for the screen to warm up.
2. The Turn-On page will be displayed for a few seconds (figure 3-3). During this time the KLN 90B performs an extensive internal test. The ORS (Operational Revision Status) level number in the upper right corner of the display should match the **ORS** level indicated on the first page of this Pilot's Guide (page before Table of Contents). If desired, you may program four lines of personalized information which is displayed each time the Turn-On page is in view. The procedure for doing this is described in section 5.7.

When the internal test is complete, the Turn-On page will automatically be replaced by the Self Test page (figure 3-4). Note: if the KLN 90B is operating in the take-home mode, the Take-Home Warning page (figure 3-5) is displayed first and must be acknowledged by pressing **ENT**. See section 5.14 for more information on the Take-Home mode.

3. Adjust the display brightness to the desired level by rotating the power/brightness knob. Clockwise rotation increases brightness and counterclockwise rotation decreases brightness.
4. Verify that the data displayed on the left side of the Self Test page is the same as is being displayed on the appropriate equipment in the aircraft which is interfaced to the KLN 90B. If the KLN 90B is not connected to any other equipment in the aircraft, you may skip to step 5.



Figure 3-3

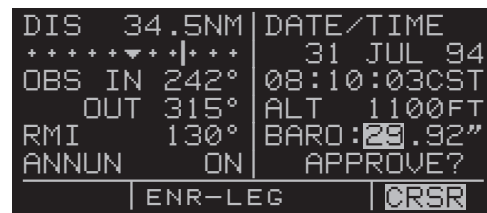

Figure 3-4

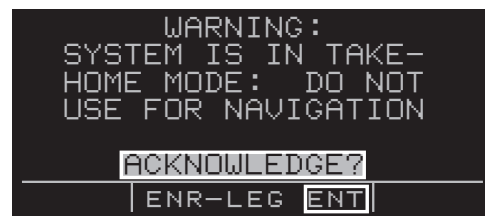

Figure 3-5

The distance field (**DIS**) always displays 34.5 NM (nautical miles). If the KLN 90B is interfaced to a compatible indicator that displays DME distance, the indicator should be displaying 34.5 nautical miles.

If the KLN 90B is interfaced with a mechanical NAV indicator such as an HSI or a course deviation indicator (CDI), the D-bar (deviation bar) should be indicating a half scale deviation to the right. In some EFIS installations the D-bar may be deflected one third of full scale. This is due to the different CDI scale factors that are used. The TO/FROM indicator should be showing FROM.

If the KLN 90B is interfaced with a NAV indicator such that the KLN 90B can "read" the selected course from the NAV indicator, then the **OBS IN** field should display the same course as on the NAV indicator.

The **OBS OUT** field always displays 315 degrees and is only applicable when the KLN 90B is interfaced with an HSI which has a driven course pointer capable of being driven by the KLN 90B. This type of HSI is normally found in jets and turboprops. If this type of NAV indicator is interfaced to the KLN 90B, the course pointer on the NAV indicator should be driven to 315 degrees and both the **OBS IN** and **OBS OUT** fields should be displaying 315 degrees.

The **RMI** field always displays 130 degrees. If the KLN 90B is connected to a compatible RMI in the aircraft, the RMI should indicate a bearing to the station of 130 degrees.

If any of the above checks fail, do not use the associated equipment with the KLN 90B.

5. If the KLN 90B has passed the internal self test, the bottom left side of the Self Test page will display **ANNUN ON** to indicate that the external annunciators, if installed, should all be illuminated. If instead, a flashing **TEST FAIL** is displayed, recycle power to the KLN 90B. If the Self Test page still displays **TEST FAIL**, the KLN 90B requires repair and should not be used for navigation.

The KLN 90B needs to have the correct time, date, and position to be able to determine which satellites should be in view. This information is stored in the battery backed memory of the KLN 90B so it is not normally required to update it. If the KLN 90B has the correct time, date, and position, then the time to first fix will usually be just a couple of minutes or less. If this information is not correct, then the KLN 90B will start to look for any satellites. Eventually, the KLN 90B will find enough satellites to determine the position of the aircraft. This process can take as long as 12 minutes but will normally be around 6 minutes. It is possible for you to update this information manually which will allow the KLN 90B to reach a NAV ready status much faster. To set the time and date follow steps 6 and 7. If the date and time are correct, or acquisition time is not important, then skip to step 8.



Figure 3-6



Figure 3-7

6. If the date is incorrect, rotate the right outer knob counterclockwise until the cursor is over the entire date field (figure 3-6). Rotate the right inner knob until the correct day of the month is displayed (figure 3-7). Then, rotate the right outer knob one step clockwise to place the flashing part of the cursor over the month field (figure 3-8). Rotate the right inner knob to display the correct month (figure 3-9). Rotate the right outer knob one step clockwise again and use the right inner knob to select the first digit of the correct year (Figure 3-10). Next, rotate the right outer knob one more step clockwise and then use the right inner knob to select the second digit of the year (figure 3-11). When the date is correct, press **ENTER**.



Figure 3-8



Figure 3-9

7. If it is necessary to reset the time, use the right outer knob to position the cursor over the time zone field (figure 3-12). Use the right inner knob to select the desired time zone (figure 3-13). The following are the time zones which the KLN 90B is capable of displaying:



Figure 3-10



Figure 3-11

UTC	Coordinated Universal Time (Zulu)
GST	Greenland Standard Time (UTC - 3)
GDT	Greenland Daylight Time (UTC - 2)
ATS	Atlantic Standard Time (UTC - 4)
ATD	Atlantic Daylight Time (UTC - 3)
EST	Eastern Standard Time (UTC - 5)
EDT	Eastern Daylight Time (UTC - 4)
CST	Central Standard Time (UTC - 6)
CDT	Central Daylight Time (UTC - 5)
MST	Mountain Standard Time (UTC - 7)
MDT	Mountain Daylight Time (UTC - 6)
PST	Pacific Standard Time (UTC - 8)
PDT	Pacific Daylight Time (UTC - 7)
AKS	Alaska Standard Time (UTC - 9)
AKD	Alaska Daylight Time (UTC - 8)
HAS	Hawaii Standard Time (UTC - 10)
HAD	Hawaii Daylight Time (UTC - 9)
SST	Samoa Standard Time (UTC - 11)
SDT	Samoa Daylight Time (UTC - 10)



Figure 3-12



Figure 3-13

You will be able to change the time zone any time you desire on several other pages, so don't worry if you're not sure which time zone to choose. UTC - Coordinated Universal Time (also called "Zulu") is always a safe choice.

Once you have selected the desired time zone, turn the right outer knob one step counterclockwise to position the cursor over the entire time field (figure 3-14). Use the right inner knob to select the correct hour (figure 3-15). Since 24 hour time is used, be sure to add 12 if the time is after 1:00 P.M.(2:30 P.M. becomes 14:30). Now turn the right outer knob one step clockwise to position the flashing part of the cursor over the first minute's position (figure 3-16). Turn the right inner knob to select the desired value. Turning the right outer knob one more step clockwise positions the flashing part of the cursor over the second minute's position, and the right inner knob is now used to finalize the time selection (figure 3-17). When the correct time has been entered, press **■** to start the clock running. Don't worry that you can't update the seconds. The KLN 90B system time will automatically be corrected very precisely once a satellite is received.

- Turn the right outer knob clockwise to position the cursor over the first two digits of the altimeter baro set field if the cursor is not there already (figure 3-18). The last KLN 90B baro setting entered is displayed. If the correct altimeter setting is displayed skip to step 10 after reading the following notes.

NOTE: The KLN 90B will use an altitude input from an altitude encoder or air data computer. Since the altitude from these devices is usually pressure altitude, an altimeter baro correction is required to ensure maximum accuracy. This altitude input is used for altitude related features of the KLN 90B. Therefore, it is important to keep the altimeter baro setting updated on the Self Test page when power is first applied to the KLN 90B and on the Altitude page each time a new baro correction is made to the aircraft's altimeter.

NOTE: The units of the altimeter baro setting may be changed at a later time from inches to millibars on the SET 7 page.

NOTE: The altimeter baro set field will not be a cursor field if the KLN 90B is interfaced to certain air data/altimeter systems which update the baro set field when the aircraft's altimeter baro setting is updated.



Figure 3-14



Figure 3-15



Figure 3-16



Figure 3-17



Figure 3-18

9. To enter the correct baro setting, rotate the right inner knob to select the first two digits of the correct altimeter setting (figure 3-19). Rotate the right outer knob one step clockwise to move the flashing cursor over the third position. Use the right inner knob to select the correct number. Use the right outer and inner knobs to complete the baro setting (figure 3-20). Now press **ENT**.



Figure 3-19



Figure 3-20

10. With the correct altimeter setting entered, the altitude displayed on line 4 should be correct within 100 feet.

11. Turn the right outer knob clockwise to position the cursor over **APPROVE?** if it is not there already (figure 3-21). Press **ENT** to approve the Self Test page. If the KLN 90B altitude alert audio is utilized in the installation, five beeps should be heard when the Self Test page is approved. The alert audio volume may later be adjusted on the SET 9 page. (Note: If the KLN 90B is installed for VFR only operation, a VFR only warning page is displayed after the self test page has been approved (Figure 3-22). This warning page must be acknowledged by pressing **ENT**.) If the KLN 90B is installed with an external GPS CRS switch and the switch is in the OBS position, then the OBS warning page will be displayed (figure 3-23). The GPS CRS switch should be pushed so that the LEG mode is selected.)



Figure 3-21



Figure 3-22

12. The Database page will now be displayed with the cursor over **ACKNOWLEDGE?**. Line 1 indicates the coverage area of the database being used. If the database is current, line 3 will show the date when the database expires (figure 3-24).

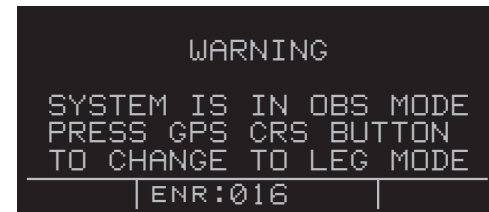

Figure 3-23

If the database is out of date, line 3 shows the date that it expired (figure 3-25). The KLN 90B will still function with an out of date database; however, you must exercise extreme caution and always verify that the database information is correct before using information from an out of date database.

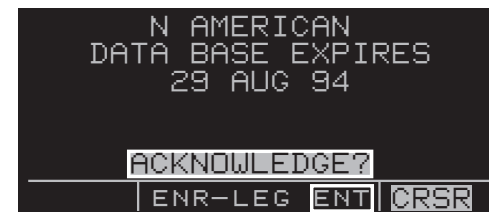

Figure 3-24

Press **ENT** to acknowledge the information on the Database page.

WARNING: The accuracy of the database information is assured only if the database is current. Operators using an out of date database do so entirely at their own risk.

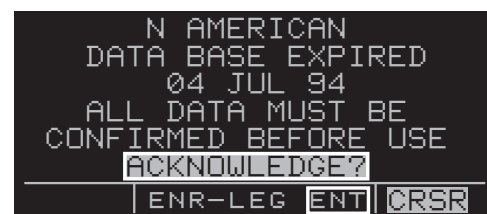

Figure 3-25

The NAV 2 page (present position) is now automatically displayed on the left side of the screen and the waypoint page for the waypoint which was active when the KLN 90B was last turned off will be displayed on the right side (figure 3-26). If the last active waypoint was an airport, the APT 4 page (airport communications) will be displayed. Isn't that convenient! Almost always, the waypoint which was active when you last removed power from the KLN 90B is the airport where you landed. Therefore, when you get ready to depart, the airport communication frequencies for that airport will automatically be displayed for you!

PRESENT POS	→KHIF
--- °FR	CLR 124.10
--- -NM	GRND 121.60
- °--'	TWR 126.20
--- °--'	APR 121.10
--- °--'	DEP 121.10
NAV 2	ENR-LEG APT 4

Figure 3-26

PRESENT POS
OGD 122°FR
8.2NM
N 41°07.60'
W 111°58.30'
NAV 2

Figure 3-27

When the NAV 2 page first appears, it is possible that the present position will be dashed. It can take the KLN 90B several minutes to acquire the GPS satellites and to make its initial calculation of your position. When the KLN 90B reaches a NAV ready status and is able to navigate, the NAV 2 page will display your present position in two ways (figure 3-27). The bottom of the page will display the aircraft's latitude and longitude. Above the latitude/longitude position is the present position expressed as the distance and radial from a nearby VOR. The VOR displayed on the NAV 2 page is the nearest low or high altitude class VOR. Terminal class VORs are not used because many charts do not depict a compass rose around them and verifying the displayed radial would be difficult. Verify that the present position shown on the NAV 2 page is correct.

NOTE: In order to reach a NAV ready status, the aircraft must be away from obstructions blocking the GPS antenna's view of required satellites. If the KLN 90B fails to reach a NAV ready status within five minutes, refer to section 3.6, "Initialization and Time To First Fix".

NOTE: When the KLN 90B is interfaced with certain Shadin fuel flow computers, the KLN 90B will present the following message after the start-up sequence:

**SET FUEL ON BOARD
ON OTH 5 IF NECESSARY**

Turn to section 5.10.1 for details on this operation.

3.3 DISPLAY FORMAT

The KLN 90B uses a Cathode Ray Tube (CRT) display. The display screen is divided into segments. These segments are formed by horizontal and vertical lines on the screen. Most of the time there are five segments as shown in figure 3-28. There are occasionally times when there are only four segments (figure 3-29) or one large segment (figure 3-30).

Aeronautical information (also called “data”) is presented on the screen in the form of “pages”. A page is a presentation of specific data in an organized format. Various page “types” are used to display related kinds of data. For example, one page type is NAV (navigation). NAV pages show information such as distance, groundspeed, bearing, course, and other data relating to navigation. Another page type is APT (airport). APT pages contain information pertinent to a specific airport such as name, location, elevation, runways, and communication frequencies. There are numerous page types used to display the KLN 90B’s vast capabilities.

Normally, when the screen is divided into five segments, the KLN 90B displays two pages at one time. These pages are presented in the upper left and upper right segments of the screen. In figure 3-31 the upper left segment (A) is showing a Navigation page and the upper right segment (B) is showing an Airport page. The lower left segment (C) indicates which specific page is being displayed on the left side. **NAV 2** indicates that the Navigation 2 page is being presented on the left side of the screen. An Airport 4 page is being shown in the upper right segment of the display (B) and is identified as such with the **APT 4** characters in the lower right segment (D). The page identification includes a number appended to the page type when there is more than one page for a page type, such as in the two examples of pages shown in figure 3-31. There is no number displayed in the page identifier if there is only one page for a particular page type. The **VOR** page identification in figure 3-32 shows that there is only one VOR page.

You might think of the page types as the chapters in a book and the page numbers as the pages within a chapter. Just as a chapter in a book may have from one to many pages, a KLN 90B page type may have from one to 26 pages associated with it. There are, for example, 26 Flight Plan pages (FPL0, FPL1, FPL2,...,FPL25) in the Flight Plan type and eight Airport pages (APT 1, APT 2, ..., APT 8) in the Airport type. There is one VOR page in the VOR type.

Figure 3-33 shows another example of an Airport 4 page. As you have previously seen, the Airport 4 page is always used to show airport communication frequencies. Notice the “+” sign in the **APT+4** identification. Whenever a “+” sign is part of a page identifier there will be two or more

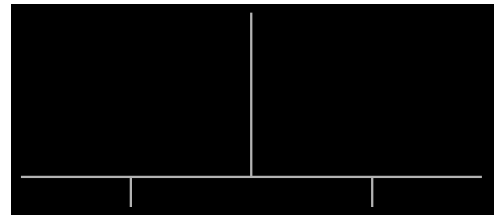

Figure 3-28



Figure 3-29

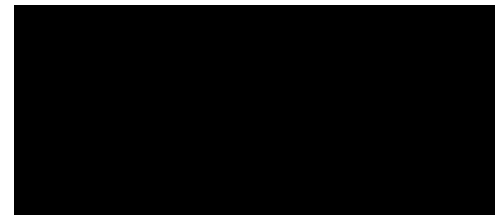

Figure 3-30

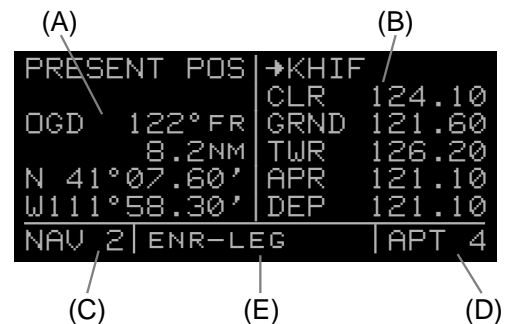

Figure 3-31

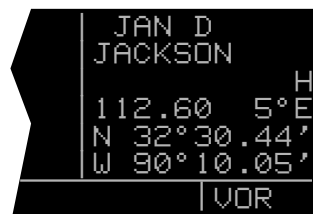

Figure 3-32



Figure 3-33

pages, all having the same page number, used to present all of the required information. That is, all of the information associated with a particular page number doesn't fit on the page being viewed. In this case the "+" sign indicates that there are two or more APT 4 pages. Figure 3-34 shows the second APT 4 page for **KMKC** (Kansas City Downtown airport).



Figure 3-34

The lower center segment (E) of the display (figure 3-31) is used to present four different kinds of information. The first seven spaces of this segment indicate the mode in which the KLN 90B is operating. In figure 3-31, **ENR-LEG** designates the unit is in the Enroute-Leg mode of operation. The Enroute-Leg mode is the normal mode of operation. The OBS mode is described in section 5.9 and the approach modes are described in chapter 6. These other modes are used primarily for approach operations.

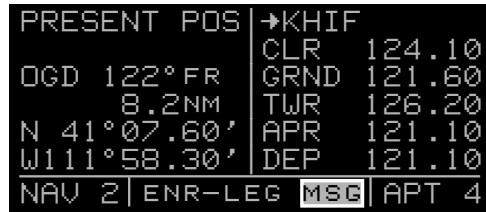

Figure 3-35

The last three spaces of segment (E) are usually blank but may contain the characters **MSG** or **ENT**. The characters **MSG** in figure 3-35 indicate that there is a message to be viewed on the Message page - accomplished by pressing **MSG**. The characters **ENT** will flash in these spaces when it is necessary to press **ENT** to complete various kinds of operations (figure 3-36).

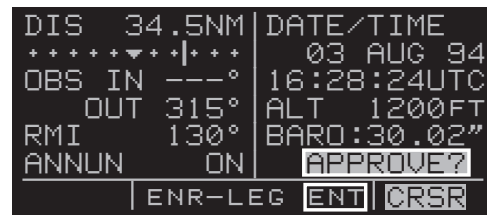

Figure 3-36

Segment (E) is also used as an area for displaying short operational messages to the user called "status line messages". These messages are displayed for approximately five seconds, then this segment returns to its previous display. An example of a status line message is shown in figure 3-37. A complete listing of status line messages is contained in appendix C of this Pilot's Guide.



Figure 3-37

3.4 BASIC OPERATION OF PANEL CONTROLS

Remember that figure 3-2 is on a fold-out page that you may want to refer to as you read this chapter.

The KLN 90B has five knobs and seven buttons which are used to perform all operations. In general, the two concentric knobs and the cursor button (■) located on the left side of the unit are used to select pages and enter data on the left side of the screen. Likewise, the two concentric knobs and the cursor button on the right side of the unit are used to select pages and enter data on the right side of the screen.

The cursor is an area of inverse video (dark characters on a light background) on the screen. Many pages allow you to add, delete, or change data on the screen by first pressing the appropriate ■ button (left ■ for left side of screen and right ■ for right side) to turn the cursor function on and bring the cursor on the screen. The appropriate knobs are then used to enter the data. When a cursor is on the screen, the page name normally shown in the lower left and right segments is replaced with a **CRSR** annunciation in inverse video (figure 3-38). The cursor is over the identifier **TUL**. Not all pages allow you to make data entry and therefore pressing the ■ button while these pages are displayed will have no effect.

There are times when the cursor is flashing. Figure 3-36 shows an example of how a white border is used in this Pilot's Guide to depict a flashing cursor (over **APPROVE?**). In addition, figure 3-36 shows an example of how a white border around normal text in this Pilot's Guide is used to depict normal characters flashing. The letters **ENT** are flashing but are not in inverse video.



Figure 3-38

3.4.1 Page Selection

It's now time for learning to select a desired page.

NOTE: The cursor function, which is controlled by the left and right (cursor) buttons, is not used in selecting pages and the buttons should not be pressed at this time. If **CRSR** is annunciated in the lower left or right segments of the display, press the left or right button (as appropriate) to turn the cursor function off.

The left outer knob is rotated to select one of eight page types for the left side of the screen. These eight page types are the following:

<u>Page Annunciation</u>	<u>Knob Annunciation</u>	<u>Page Name</u>	<u>Page Numbers</u>
TRI	TRIP	Trip Planning	0-6
MOD	MODE	Mode	1-2
FPL	FPL	Flight Plan	0-25
NAV	NAV	Navigation	1-5
CAL	CALC	Calculator	1-7
STA	STAT	Status	1-5
SET	SETUP	Setup	0-9
OTH	OTHER	Other	1-4*

*up to 10 with fuel management system and air data interfaces

Remember that the page type for the left side is always annunciated in the lower left segment of the screen. The first three letters of the page type are always used for annunciation on the screen **TRI** for TRIP, **MOD** for Mode, **SET** for SETUP, etc. Rotating the left outer knob clockwise selects the page type in the top-to-bottom order shown above. Rotating the left outer knob counterclockwise selects the page type in the opposite order. The page type selection wraps around from OTHER to TRIP; that is, the knob has no mechanical stops.

Once you have selected the desired page type using the left outer knob, you may select the page number by rotating the left inner knob. Let's use an example to make sure you understand. You are presently viewing the NAV 2 page on the left page. You wish to view the CAL 5 page. Rotating the left outer knob one step clockwise will display the CAL page that you last viewed—we'll say the Calculator 1 page. Turning the left inner knob four steps clockwise or three steps counterclockwise will bring you to the CAL 5 page. Got it?

You've probably already figured out that the right side of the unit operates in a similar manner to the left side. There are, however, a couple of differences. First, the page types are different for the right side except for NAV. The Navigation pages are identical on both sides of the screen. Just as on the left side, only the first three letters of the page type are used for annunciation on the screen. The page types for the right side are the following:

<u>Page Annunciation</u>	<u>Knob Annunciation</u>	<u>Page Name</u>	<u>Page Numbers</u>
CTR	CTR	Center Wpt.	1-2
REF	REF	Reference Wpt.	None
ACT	ACTV	Active Wpt.	**
D/T	D/T	Distance/Time	1-4
NAV	NAV	Navigation	1-5
APT	APT	Airport Wpt.	1-8
VOR	VOR	VOR Wpt.	None
NDB	NDB	NDB Wpt.	None
INT	INT	Intersection Wpt.	None
SUP	SUPL	Supplemental Wpt.	None

**Varies with the type of waypoints in the active flight plan

The second difference from the left side is that the right inner knob has both an "in" and an "out" position. With the knob pushed "in" it works exactly like the inner knob on the left side. Make sure the right inner knob is pushed "in" for now. Later in this chapter we'll discuss how the right inner knob in the "out" position performs a waypoint scan function.

NOTE: In this Pilot's Guide the right smaller knob is assumed to be in the "in" position unless it specifically states that the knob should be in the "out" position. Therefore, the words "rotate the right inner knob" mean to turn the right inner knob while the knob is in the "in" position.

3.4.2 Data Entry

Now that you've learned how to select the desired page, you're ready to learn the means of entering data. It is necessary to enter data, for example, in order to specify a Direct To waypoint of your choice. The general procedure for entering a waypoint identifier is described below. The Trip Planning 3 (TRI 3) page is shown in this example but the procedure is applicable to many other pages. You need not perform these steps now since they will be described again shortly.

1. If the cursor is not positioned on the screen location where you desire to enter the waypoint identifier (figure 3-39), press **←** (left **←** for left page or right **→** for right page) to turn on the cursor function (figure 3-40).
2. If required, rotate the outer knob (left outer knob for left page or right outer knob for right page) to position the cursor in the desired location (figure 3-41).
3. Rotate the appropriate inner knob to select the first character of the waypoint identifier (figure 3-42).
4. Turn the appropriate outer knob one step clockwise to move the cursor to the second character position (figure 3-43).
5. Rotate the inner knob to select the second character (figure 3-44).
6. Use the outer and inner knobs in this manner until the complete waypoint identifier is displayed (figure 3-45). Note that you may not have to enter the last characters of the identifier because each time you enter a character, the KLN 90B offers you the first identifier in the database beginning with the characters you have entered.
7. If **ENT** is flashing in the lower middle segment of the display, then press **←**. This will display a waypoint page on the right side of the screen for the waypoint identifier you just entered (figure 3-46).
8. Verify the waypoint information displayed, and then press **←** again to approve the waypoint page. The right side will return to the page previously displayed (figure 3-47).

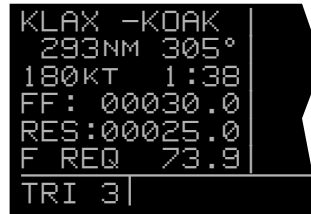

Figure 3-39



Figure 3-40



Figure 3-41

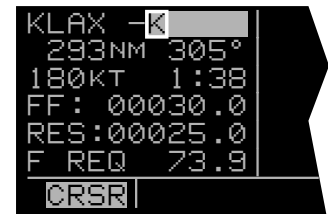

Figure 3-42



Figure 3-43

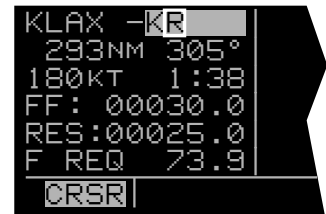

Figure 3-44



Figure 3-45

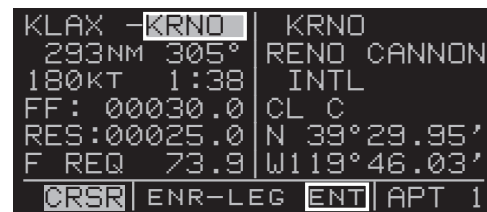

Figure 3-46

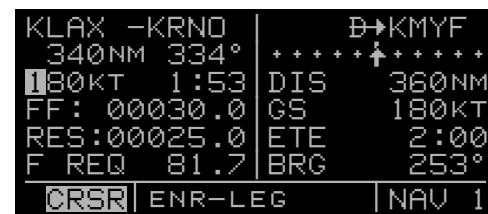

Figure 3-47

3.4.3 Alternative Waypoint Data Entry Method

There is another method of data entry for waypoints which you will sometimes find convenient. This method applies when there is a page on the left side of the screen with the cursor over a field where a waypoint is enterable. You may fill the waypoint field on the left side by first selecting the desired waypoint page on the right side (figure 3-48). When **ENT** is pressed, the waypoint field on the left will contain the flashing identifier of the waypoint that is displayed on the right side (figure 3-49). To finalize the section, **ENT** is pressed again (figure 3-50).

3.4.4 The Duplicate Waypoint Page

There are some waypoints in the database whose identifiers are not unique. That is, more than one waypoint has the same identifier. When a waypoint identifier has been entered which is not unique to a single waypoint, a Duplicate Waypoint page appears on the left side (figure 3-52). The Duplicate Waypoint page is used to select which of the waypoints having the same identifier is actually desired. The waypoint identifier is displayed on the top left of the page. To the right of the identifier is the number of waypoints in the database having the identifier. Below the identifier is a list of the waypoint types (APT, VOR, NDB, INT, SUP) and the associated countries which use the identifier. To see an example of a Duplicate Waypoint page perform the following steps:

1. Press **ENT**.
2. Turn the left inner knob to select the letter "D" as a waypoint identifier (figure 3-51). "D" is the full identifier of several waypoints in the KLN 90B database.
3. Press **ENT**. The Duplicate Waypoint page will be displayed on the left side (figure 3-52). At the time of this writing, there were ten waypoints in the database having the identifier "D". As in this example, if there are more than four waypoints having the same identifier, only the first four are initially shown. The list includes an NDB in Canada, an NDB in Cuba, an NDB in the United States, and an NDB in Libya. The cursor will be over the first waypoint listed. They are listed with the waypoint closest to the aircraft's present position displayed first and the waypoint farthest from the aircraft displayed last. To view the rest, rotate the left outer knob clockwise. Doing so will move the flashing cursor over waypoints two, three, and four and then will cause the waypoint list to "scroll" so that the other waypoints in the list may be seen. To select the desired waypoint, move the cursor over the appropriate choice (figure 3-53).
4. Press **ENT** to view the waypoint page for the selected waypoint (figure 3-54).
5. Press **ENT** to approve the waypoint page.

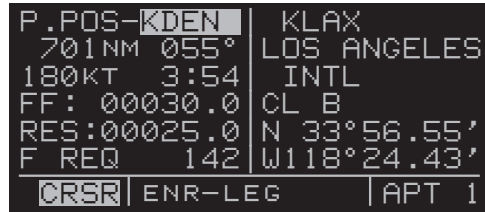

Figure 3-48



Figure 3-49

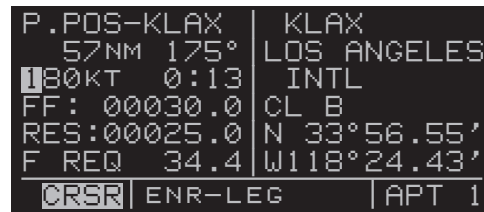

Figure 3-50

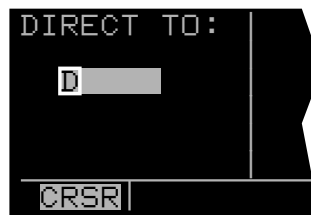

Figure 3-51

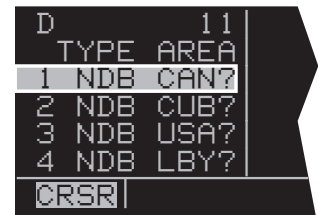

Figure 3-52

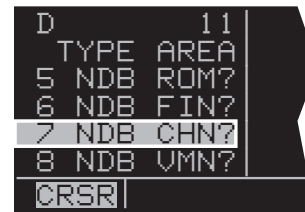

Figure 3-53



Figure 3-54

3.5 MESSAGE PAGE

Whenever the KLN 90B determines that there is a situation that requires your attention, the MSG prompt begins flashing in inverse video at the bottom of the display just to the right of the mode of operation (figure 3-55). A remote message annunciator may also be installed in the aircraft instrument panel. You should view the message at your earliest opportunity because the unit may be alerting you to some condition of immediate concern to its condition or to your flight. To view the message, press **■**. The MSG page, which takes the whole width of the display, will appear and show the new message (figure 3-56). Appendix B of this Pilot's Guide contains a listing of all the Message page messages and their meanings. It is possible that several messages are displayed at one time on the Message page. The newest message appears first and the rest in reverse chronological order.

After reading the message, press **■** again to return to the pages which were previously in view. If all of the messages cannot be displayed on one Message page, repeated presses of **■** will show the other messages before returning to the pages which were previously being viewed. Whenever a message condition exists which requires a specific action by you, the message prompt will remain on but not flashing.

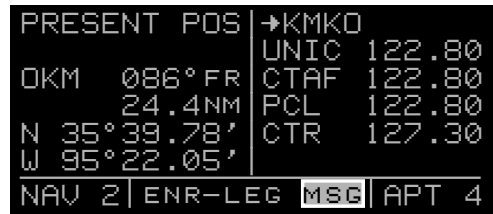

Figure 3-55



Figure 3-56

3.6 INITIALIZATION AND TIME TO FIRST FIX

Since the KLN 90B stores its position and other required parameters in memory when power to the unit is removed, it is seldom necessary to aid the unit in reaching a NAV ready condition. The time required from power on until the KLN 90B determines its present position and is therefore ready to navigate is called "time to first fix." The time to first fix is normally a few minutes or less. In order for the KLN 90B to reach a NAV ready condition, it is necessary to meet the following conditions:

1. The KLN 90B's "almanac" data must be current. Almanac data is crude orbital information for all the satellites and is used for initial acquisition when the KLN 90B is first turned on. This data is stored in the KLN 90B's non-volatile memory and is considered current for up to six months. Each satellite sends almanac data for all satellites. Since the KLN 90B routinely updates the almanac data during normal operation, the almanac data will become out of date only if the KLN 90B hasn't been used for the previous six months or longer. Collecting new almanac data takes place automatically if the data is more than six months old. If the almanac data is out of date and needs to be collected, the KLN 90B will take a few minutes to acquire your present position (usually about six (6) minutes, but not more than 12 minutes). The Self Test and Database pages should be approved.
2. The aircraft must be located such that the GPS antenna has an unobstructed view of the sky so that required satellite signals are not being blocked. If necessary, position the aircraft away from hangars or other obstructions.
3. It is very helpful for the KLN 90B to have the correct time, date and position to be able to determine which satellites should be in view. This information is stored in the battery backed memory of the KLN 90B so it is not normally required to update it. If the KLN 90B has the correct time, date and position, then the time to first fix will usually be less than two (2) minutes. If this information is not correct, then the KLN 90B will start to look for any satellites. Eventually, the KLN 90B will find enough satellites to determine the position of the aircraft. This process can take as long as 12 minutes. It is possible for you to update this information manually which will allow the KLN 90B to reach a NAV ready status much faster. To set the time and date follow steps 6 and 7 in section 3.2, "Turn-On and Self-Test." If it is necessary to update the position then use the following steps. Remember, if acquisition time is not important then it is not necessary to update the time, date or position.

1. Select the Setup 1 page (**SET 1**) by first turning the left outer knob to display a **SET** type page. Next, turn the left inner knob until the **SET 1** page is selected (figure 3-57).
2. Press the left **█** to bring the cursor on the page over the WPT field (figure 3-58).
3. Use the left inner knob to enter the first character of the identifier for the airport where you are presently located or the identifier of a navaid or other airport which is close to you. Remember, if you are entering an airport identifier that is all letters (no numbers), then it will begin with a "K" prefix in the Contiguous U.S., a "P" in Alaska, or a "C" in Canada. If there are numbers in the identifier then a prefix is not used. Outside the Contiguous U.S., Alaska, and Canada, use the airport identifiers as they are charted.
4. Rotate the left outer knob one step clockwise to move the flashing portion of the cursor to the second position and then use the left inner knob to enter the second character of the identifier.
5. Complete entering the rest of the identifier using the left knobs in the same manner as in step 4 (figure 3-59).
6. Press **█** to view the waypoint page on the right side.
7. Press **█** again to confirm the waypoint page.

NOTE: As an alternative, you can also enter the approximate latitude and longitude of your present position directly on the SET 1 page instead of entering a waypoint identifier.

8. Use the left outer knob to position the cursor over **CONFIRM?**, if it is not there already (figure 3-60).
9. Press **█**.

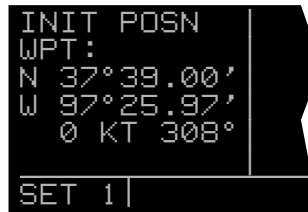

Figure 3-57

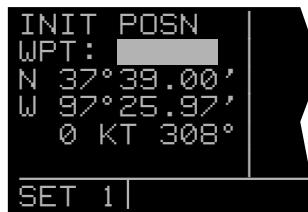

Figure 3-58

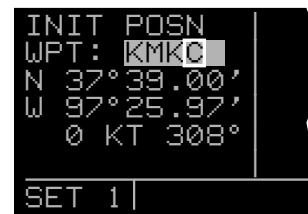

Figure 3-59



Figure 3-60

NOTE: The groundspeed (KT) and heading (°) fields are not used for actual initialization in an aircraft. However, if the KLN 90B is in the take-home mode, entering a groundspeed will allow the KLN 90B to “fly” along the active flight plan (or to a direct to waypoint) starting from the initialization waypoint. A heading may be entered in the initial heading field while in the take-home mode if the one offered is not desired. If the take-home mode is used, remember to re-initialize the KLN 90B to the aircraft’s location before reinstalling it back in the aircraft.

10. Use the left knobs to select the NAV 2 page. When the KLN 90B reaches the NAV ready status and is therefore able to navigate, the NAV 2 page will display the present position. Verify that the latitude and longitude or the VOR, radial, and distance display of present position are correct.

3.7 SELECTING WAYPOINTS

There are five types of waypoints: airports, VORs, NDBs, intersections, and supplemental. Waypoints in the published database (those in the cartridge) fall into one of the first four types. Remember that you can create up to 250 of your own waypoints which you may designate as one of the first four types or you may designate it as a supplemental waypoint which simply means that it is a miscellaneous waypoint that doesn't fit into one of the other categories.

There are three methods you may use to select a specific waypoint for viewing. You may enter the waypoint's identifier directly, you may scan through the waypoint identifiers in alphabetical order, or, you may enter the waypoint's name. If the waypoint is an airport, you may also select it by entering the city where the airport is located.

3.7.1 Selecting Waypoints By Identifier

The most direct way of selecting a specific waypoint is to simply enter the waypoint's identifier directly on the appropriate waypoint page type (APT, for example). Let's use San Antonio International airport whose identifier is **KSAT** as an example to illustrate how this is done.

1. Rotate the right outer knob to select the airport type pages (APT). Rotate the right inner knob to select the APT 1 page if it is not already in view (figure 3-61). (Actually, the airport identifier can be entered on any of the eight Airport pages but we'll use the APT 1 since it displays the airport name.)
2. Press the right █ to bring the cursor on the screen over the first character in the airport identifier (figure 3-62). The right inner knob should be pushed in the "in" position.
3. Turn the right inner knob to select a "K" (figure 3-63). You may turn the knob either clockwise or counter-clockwise, the letters and numbers wrap around with a blank character separating the "9" and the "A". Go ahead and experiment a little bit.
4. Rotate the right outer knob one step clockwise to position the cursor over the second character in the airport identifier (figure 3-64).
5. Use the right inner knob to select the second character, "S" (figure 3-65).
6. Use the right outer and right inner knobs in the same manner as above to select the "A" and the "T" (figure 3-66). You are now viewing the APT 1 page for **KSAT**.
7. Press the right █ to remove the cursor from the right page. The APT 2, APT 3, APT 4, APT 5, APT 6, APT 7 and APT 8 pages may be viewed by rotating the right inner knob.

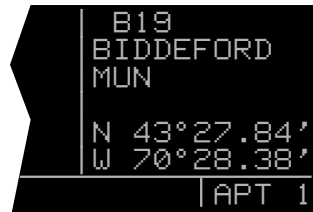

Figure 3-61



Figure 3-62



Figure 3-63



Figure 3-64



Figure 3-65

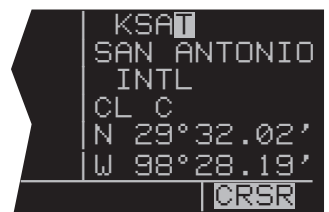



Figure 3-66

Did you notice that as you entered the “K” in step 3 that the second and third characters also changed? That is because every time you enter a character (in this case the “K”), the KLN 90B searches its database to offer the first waypoint in the database which begins with the characters you have already entered. Since the KLN 90B considers numbers lower in order than letters, **K00** is the first airport identifier in the database beginning with a “K”. Let’s do one more example to show how this database search can save you time and effort.

For the second example let’s select Bloomington VOR whose identifier is **BMI**.

1. Make sure you have turned the right cursor off from the previous example. Now rotate the right outer knob to display a VOR type page (figure 3-67).
2. Press the right  to bring the cursor on the screen over the first character in the VOR identifier (figure 3-68).
3. Enter a “B” with the right inner knob (figure 3-69).
4. Use the right outer knob to position the cursor over the second character and use the right inner knob to select the “M” (figure 3-70). Surprise! When you entered the “M”, the KLN 90B searched its database for the first VOR identifier beginning with “BM” and found **BMI**. You didn’t have to enter the last character. Many times you will only have to enter several characters of the waypoint identifier and the KLN 90B will furnish the rest.
5. Press the right  when you are done entering data so you can view other pages.

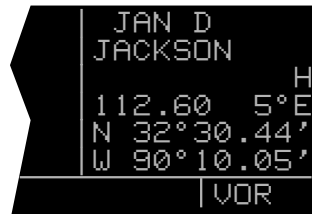

Figure 3-67

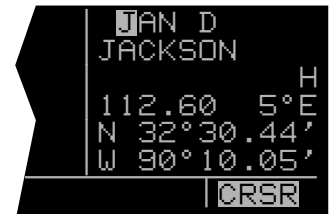

Figure 3-68



Figure 3-69

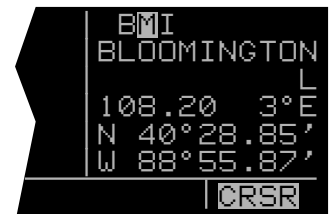

Figure 3-70

3.7.2 Selecting Waypoints By Scanning

To select waypoints using the scanning method:

1. Select the desired waypoint type (**APT**, **VOR**, **NDB**, **INT**, or **SUP**) on the right side by using the right outer knob.
2. Pull the right inner knob to the "out" position.
3. Turn the right inner knob clockwise to scan through the waypoints in alphabetical order, or counterclockwise to scan in reverse alphabetical order. Remember that numbers are considered lower in order than letters. Thus, the airport identifier **K98** comes before **KAAF**.

The faster you turn the knob while scanning, the larger the step through the waypoints. This variable rate scanning allows you to get from one end of the list to the other very quickly. When the knob is turned slowly, you will go through the waypoints one at a time.

3.7.3 “Nearest” And “Complete” Waypoint Scan

Lists

There are actually two waypoint scan lists for airports, VORs, and NDBs. These two lists are the “complete” list and the “nearest” list. The complete list contains all of the waypoints in the database for a waypoint type (all the airports for example). The nearest list consists of the nine nearest waypoints to your present position. Therefore, if you are in the nearest airport list, it will contain the nine nearest airports relative to your location. There is no “nearest” list for intersections (INT) and supplemental waypoints (SUP).

The nearest list is positioned in front of the complete list. That is, you must scan backwards (turn the knob counter-clockwise) through the complete list to reach the nearest list. You will know when you have reached the nearest list because the top right portion of the waypoint page will flash the relative position of the waypoint to your position. “NR1” indicates nearest (figure 3-71) while “NR 9” indicates the ninth nearest (figure 3-72). As you scan clockwise “NR 1, NR 2, NR 3,...,NR 9”, the next scan position is the beginning of the complete list. The nearest list can only be reached scanning backwards. It does not wrap around after the last waypoint in the complete list.

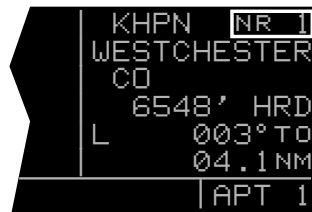

Figure 3-71

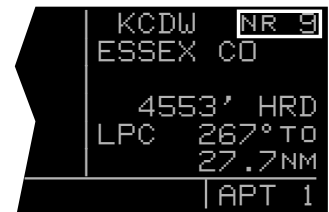

Figure 3-72

Waypoint pages displayed in the nearest list do not contain a latitude and longitude position as they do in the complete list. Instead, the bearing and distance to the waypoint are displayed. In addition, nearest airport pages display the length, surface, and lighting of the longest runway. Once the nearest airport is being displayed, the other airport pages (APT 2-APT 8) for that airport are available for display by making sure the right inner knob is pressed in and then turning it to select the desired airport page.

The nine airports in the nearest list are the nine airports which meet the criteria selected on the Setup 3 page (SET 3). The SET 3 page allows you to specify what criteria you want an airport to meet before it is considered for the nearest airport list. To specify the airport criteria:

1. Select the SET 3 page on the left side (figure 3-73).
2. Press the left █ to turn on the left cursor function. The cursor will appear over the minimum runway length field.
3. Use the left inner knob to select the minimum length runway desired for the airport to qualify for the nearest airport list (figure 3-74). Values between 1000 feet and 5000 feet in 100 foot increments may be selected.
4. Rotate the left outer knob one step clockwise to position the cursor over the runway surface criteria (figure 3-75).



Figure 3-73



Figure 3-74



Figure 3-75

5. Turn the left inner knob to select either **HRD SFT** or to select **HRD**. If **HRD SFT** is chosen, then both hard and soft surface runways meeting the required runway length will be included in the nearest airport list. If **HRD** is chosen, then only hard surface runways will be included. Hard surface runways include concrete, asphalt, pavement, tarmac, brick, bitumen, and sealed. Soft surface runways include turf, gravel, clay, sand, dirt, ice, steel matting, shale, and snow.

For example, if the minimum runway criteria selected is **2200** feet in length and **HRD** surface, then only airports having a hard surface runway at least 2200 feet in length will be displayed in the nearest airport list.

NOTE: *The capability to display nearest airports exists only when the KLN 90B is actually operating in the primary database coverage area. For example, if the KLN 90B contains a North American database it will not display nearest airports while operating in Europe.*

3.7.3.1 Nearest Airports In An Emergency

In the event of an emergency, a special procedure exists to very quickly get to the beginning of the nearest airport list:

1. Press **■**.
2. Press **■**. The waypoint page for the nearest airport is now displayed on the right side. The right inner knob may now be used in the normal manner to scan the other nearest airports (knob in the “out” position) or to view all eight airport pages for a specific airport (knob in the “in” position). Figure 3-71 shows an example of a nearest APT 1 page.

3.7.3.2 Continuous Display Of Nearest Airport

When the nearest airport page is initially displayed, "NR 1" is displayed in the upper right hand corner of the page to designate this airport as the nearest airport. However, if you continue to fly along your flight plan with this page selected, the same airport will be displayed and its position in the nearest airport list will change from NR 1 to NR 2, NR 3, NR 4 ... NR 9 until finally it won't be in the nearest airport list at all. The reason for this is that in the event of an actual emergency once you have determined which airport you are heading for, you don't want the nearest airport list to update while you are maneuvering or looking up data on the other airport pages for that airport.

There may be times, however, when you're flying over "unfriendly" terrain when you wish to always have the nearest airport displayed on the right side of the screen while you view another page, such as the NAV 1 page, on the left side. The means for doing this on the KLN 90B is the following:

1. Display the nearest airport page by pressing **[M]** followed by pressing **[R]**.
2. Press the right **[R]**.
3. Rotate the right outer knob clockwise to position the cursor over "NR 1" (figure 3-76). As long as the cursor is left in this position, this page will update so that the nearest airport is always shown as the flight progresses.



Figure 3-76

3.7.4 Selecting Waypoints By Name Or City

When you know the identifier of the desired waypoint you will use one of the two methods just described to select it. However, what if you know the name but you don't know the identifier or your desired waypoint? You're in luck because the KLN 90B will allow you to enter the first few characters of the name to help you find it in the database. We will use a couple of examples to illustrate how this is done. For VORs and NDBs you may use the navaid name. For airports, you may use the airport name on the APT 1 page or the city name (where the airport is located) on the APT 2 page.

In this first example we want to view the information in the KLN 90B database for Napoleon VOR (located just East of Kansas City) but we don't remember the identifier for it.

1. Turn the right outer knob to the VOR waypoint type. The VOR waypoint in view is not important.
2. Press the right **[R]**. Make sure the right inner knob is pushed to the "in" position.
3. Rotate the right outer knob clockwise until the cursor is over the first character in the VOR name which is being displayed (figure 3-77).

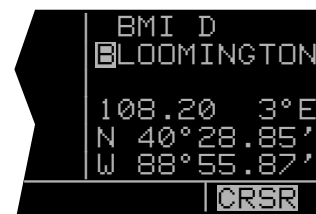

Figure 3-77

4. Turn the right inner knob to display the first character of the waypoint name, "N" in this case (figure 3-78).
5. Turn the right outer knob one step clockwise and then use the right inner knob to enter the second character, "A" (figure 3-79).
6. Use the right outer knob and right inner knob as before to select the third character, "P", and fourth character, "O" (figure 3-80). Up pops Napoleon and its identifier, **ANX!**
7. Press the right ■ to turn off the cursor function so you can view other pages.

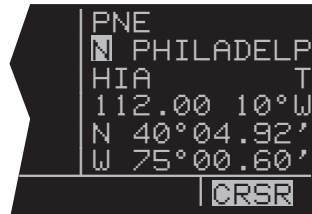

Figure 3-78

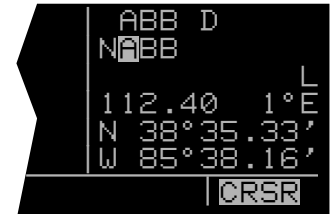

Figure 3-79

We will now use another example to show how we may enter a few characters and then scan through all the waypoints in the database beginning with those characters. Let's use this method to find the Newport News airport located in Newport News, VA.



Figure 3-80

1. Use the right outer knob to select the airport type waypoints. If the APT 1 page is not displayed, use the right inner knob to select the APT 1 page. The airport displayed at this time is not important.
2. Press the right ■ to bring the cursor on the display.
3. Rotate the right outer knob to locate the cursor over the first character in the airport name (figure 3-81).
4. Turn the right inner knob to display an "N".
5. Use the right outer and inner knobs to enter a "E" in the second character position and an "W" in the third character position.
6. Rotate the right outer knob one step clockwise to locate the cursor over the fourth character position (figure 3-82).

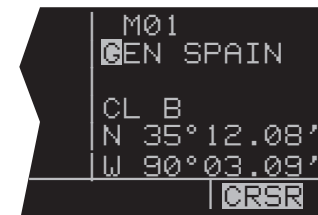

Figure 3-81

You will now scan through all the airport names beginning with "NEW".

7. Pull the right inner knob to the "out" position (figure 3-83).
8. Turn the right inner knob (in the "out" position) to scan through all the airport names beginning with "NEW".

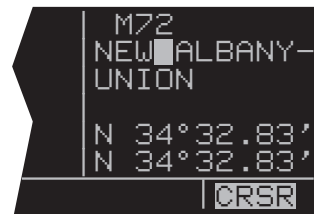

Figure 3-82

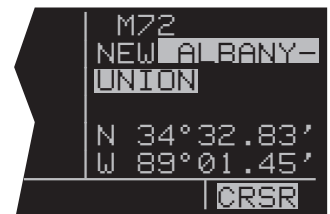

Figure 3-83

There are about seventy-nine of them. Not too good you say. We can make it a lot easier to find Newport News if we enter another character.

9. Push the right inner knob back to the "in" position.
10. Use the right inner knob to select a "P" in the fourth character position.

11. Rotate the right outer knob one more step clockwise to position the cursor over the fifth character.

12. Pull the right inner knob to the “out” position (figure 3-84). Once again rotate the knob to scan through all the airport names beginning with “NEWP”. How about that! Now there are just a few names and Newport News is easy to find, **KPHF** (figure 3-85).

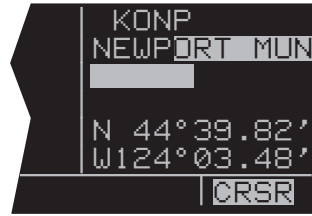

Figure 3-84



Figure 3-85

To verify that this is the airport located in Newport News, push the right inner knob to the “in” position and press the right **■**, to turn off the cursor function. Select the APT 2 page for **KPHF** to verify that **KPHF** is in Newport News (figure 3-86).

NOTE: This same method may be used on the APT 2 page with the name of the city where the airport is located.

There are a few changes made to names in order to accommodate the KLN 90B display and to make the names easier to find.

- Names which are too long to fit on the display are abbreviated. The first six characters are usually exactly correct, but the following are exceptions:
 - North, Northern, East, Eastern, etc. - uses N,E
 - Southeast, Northwest, etc. - uses SE, NW
 - Point - uses PT
 - Port - uses PT
 - Fort - uses FT
 - Saint - uses ST
 - General - uses GEN
 - Person's name - uses initials for other than last name unless very well known (Will Rogers World airport)
 - Delete “City of” (City of Colorado Springs Municipal)
 - Delete “Greater” (Greater Buffalo Intl)
 - Delete “The” (The Hartsfield Atlanta Intl)
- Unless the first word is greater than eight characters, it is usually not abbreviated.
- Delete most punctuation such as periods and apostrophes.
- Abbreviations for International are INTL, INT, and IN.
- Abbreviations for Regional are REGL and REG.

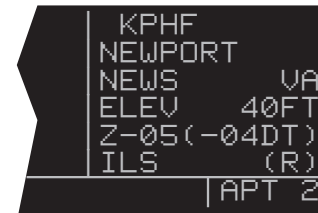

Figure 3-86

3.8 DIRECT TO OPERATION





The  button is used to initiate Direct To operation (navigation from your present position direct to your destination). When  is pressed, the Direct To page will be displayed on the left side with a flashing cursor over a waypoint identifier (figure 3-87). The waypoint identifier which appears on the Direct To page is chosen by the KLN 90B according to the following rules:





Figure 3-87

1. If the Flight Plan 0 page is displayed on the left side and the cursor is over one of the waypoint identifiers in Flight Plan 0 when  is pressed, then that waypoint identifier will appear on the Direct To page. (You will appreciate this feature when you learn to use flight plans in chapter 4).
2. If the KLN 90B is displaying the Super NAV 5 page and the right inner knob is in the “out” position, then the waypoint highlighted in the lower right hand corner of the Super NAV 5 display will be the default waypoint. (You will also find this feature useful when operating from the active flight plan especially during approaches).

If condition number 1 or 2 isn't occurring, then:

3. If there is any waypoint page (APT 1-8 page, VOR page, NDB page, INT page, SUP page, or ACT page) in view on the right side when  is pressed, then the Direct To page will contain the identifier for the waypoint page being viewed on the right side.

If none of conditions number 1, number 2 nor number 3 above are occurring, then:

4. When  is pressed, the waypoint identifier for the current active waypoint will be displayed. However, if the active waypoint is the Missed Approach Point and the aircraft is on the “from” side, then the KLN 90B will display the first waypoint of the missed approach procedure on the Direct To page.
5. If there is no active waypoint when  is pressed, then the Direct To page displays blanks. In order for there not to be an active waypoint, there is no Direct To waypoint and there are no waypoints in Flight Plan 0.

All right, rules are rules, you say. But how do I perform Direct To navigation? Since you won't learn flight plan operation until later, let's see how to apply rules 3 and 4 at this time to proceed Direct To our desired destination, Oshkosh, Wisconsin. The identifier for Wittman field in Oshkosh is **KOSH**.

3.8.1 Direct To-Procedure 1

1. Press **[CLR]**. The Direct To page is displayed on the left side (figure 3-87). The cursor will already be on the left page. A waypoint identifier may or may not be displayed, it doesn't matter at this point.
2. Rotate the left inner knob to select the first character of the desired waypoint's identifier (figure 3-88). Remember to enter the "K", "C", or "P" prefix for certain airports in North America, if required (see section 2.3, "USE OF ICAO IDENTIFIERS").
3. Turn the left outer knob one step clockwise to move the flashing portion of the cursor over the second character position (figure 3-89).
4. Rotate the left inner knob to select the second character of the identifier (figure 3-90).
5. Use the left outer and inner knobs as in the previous steps until the desired identifier is completely displayed (figure 3-91).
6. Press **[ENT]** to display the waypoint page on the right side for the selected waypoint (figure 3-92). Note: If an incorrect identifier has been entered, you may immediately start using the left inner knob to re-enter the correct identifier.
7. Press **[CLR]** again to approve the displayed waypoint page. The right side will display the NAV 1 page and the left side will return to the page which was displayed prior to pressing **[CLR]** (figure 3-93). If the Direct To was started while the NAV 1 page was shown on the left side, then the left and right pages will revert to the pages that were shown before the Direct To was started. The selected waypoint is now the active Direct To waypoint.

NOTE: In some cases during approach operations, the KLN 90B presents a page asking how a waypoint is used when the waypoint identifier is entered character by character. When this page is presented, simply choose the desired use of the waypoint (e.g., FAF or MAHP) by moving the cursor with the left outer knob and pressing **[CLR]**. Choosing the correct use of the waypoint is required to ensure proper waypoint sequencing once the aircraft reaches the waypoint.

3.8.2 Direct To-Procedure 2

1. Select the desired waypoint page on the right side (figure 3-94) using one of the three procedures explained in section 3.7, "SELECTING WAYPOINTS".
2. Press **[CLR]**. The Direct To page is displayed on the left side and it contains the desired waypoint identifier (figure 3-95).



Figure 3-88



Figure 3-89



Figure 3-90



Figure 3-91



Figure 3-92

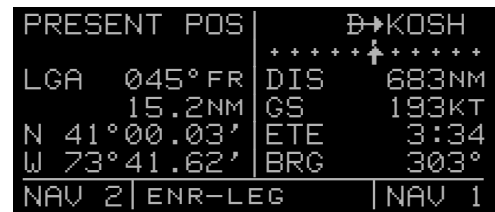

Figure 3-93

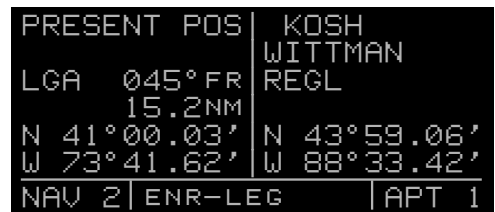

Figure 3-94



Figure 3-95

3. Press **■** to approve the waypoint page displayed on the right side. The right side will now display the NAV 1 page, and the left side will return to the page which was displayed prior to pressing **■** (figure 3-96). If the Direct To was started while the NAV 1 page was shown on the left side then the left and right pages will revert to the pages that were shown before the Direct To was started. The selected waypoint is now the active Direct To waypoint.

PRESENT POS		B→KOSH	
LGA	045°FR	DIS	683NM
	15.2NM	GS	193KT
N	41°00.03'	ETE	3:34
W	73°41.62'	BRG	303°
NAV 2 ENR-LEG		NAV 1	

Figure 3-96

3.8.3 To Recenter The D-Bar

If you get off course and wish to recenter the left/right deviation bar (D-Bar) to proceed to the same waypoint:

1. Select a non-waypoint page (**NAV, D/T, REF, or CTR**) or the active waypoint page on the right side.
2. Press **■**. The Direct To page is displayed on the left, containing the active waypoint identifier.
3. Press **■**.

NOTE: If the KLN 90B is in the approach mode and this method is used to center the D-Bar when the missed approach point is the active waypoint, then the approach mode will be cancelled and the unit will revert to the approach arm mode.

3.8.4 To Proceed Direct To Another Waypoint

You may proceed Direct To another waypoint other than the active one by using Direct To procedure 1 or 2 at any time.

3.8.5 Cancelling Direct To Operation

The primary reason for wanting to cancel Direct To operation is to return to flight plan operation which is described later in section 4.2 "OPERATING FROM THE ACTIVE FLIGHT PLAN." To cancel Direct To operation:

1. Press **■**
2. Press **■**
3. Press **■**

3.8.6 Waypoint Alerting For Direct To Operation

Approximately 36 seconds prior to reaching a Direct To waypoint, the arrow preceding the waypoint identifier on the waypoint page for the active waypoint will begin flashing. This arrow will also be flashing on any Navigation page or Distance/Time (**D/T**) page displaying the active waypoint identifier. On the Super NAV 5 page, the entire waypoint identifier will start to flash. This is called "waypoint alerting". If an external waypoint alert annunciator is mounted in the aircraft, this annunciator will begin flashing at the same time.

THIS PAGE INTENTIONALLY LEFT BLANK

3.9 THE NAVIGATION PAGES

As you would expect, the NAV (navigation) pages contain information relating specifically to the KLN 90B's navigation capabilities. The KLN 90B has five NAV pages. Unlike any other pages, these pages may be selected and viewed on both the left and right sides of the screen. The procedure for selecting specific pages, including the NAV pages, was described in section 3.4.1, "Page Selection." This section will cover all NAV pages except for the NAV 4 page (Vertical Navigation) which is explained in section 5.2.

3.9.1 The Navigation 1 Page (NAV 1)

A NAV 1 page is shown in figure 3-97. A NAV 1 page displays the following information:

- The active navigation leg. For Direct To operation this consists of the Direct To symbol, \rightarrow , followed by the active Direct To waypoint identifier (figure 3-97). For the leg of a flight plan this consists of the "from" waypoint identifier and the active "to" waypoint identifier (figure 3-98). An arrow (\rightarrow) precedes the active waypoint identifier. A course deviation indicator (CDI) that displays left and right deviation from the desired track. A vertical bar operates like a navigation deviation needle on a conventional CDI or HSI. An on-course indication is displayed when the vertical deviation bar is centered on the triangle in the middle of the CDI. In both modes each dot represents one nautical mile deviation from the desired track. Therefore, the CDI shows course deviation five nautical miles left and right of course. A vertical deviation bar positioned two dots to the right of the center triangle indicates the aircraft is two nautical miles to the left of course (figure 3-99). The center triangle also serves as the CDI's TO/FROM indicator and operates in the same manner as a conventional CDI TO/FROM indicator; an "up" triangle indicates "to" the active waypoint while a "down" triangle (figure 3-100) indicates "from" the active waypoint. The word "FLAG" is displayed over the CDI when the KLN 90B is not usable for navigation (figure 3-101).

NOTE: It is possible to change the CDI scale factor to be 0.2 nm per dot or 0.06 nm per dot. See section 5.9.8.

- Distance (**DIS**) to the active waypoint.
- Groundspeed (**GS**)
- Estimated time enroute (**ETE**)
- Bearing (**BRG**) to the active waypoint.

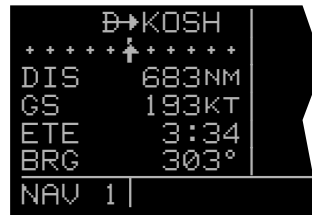

Figure 3-97

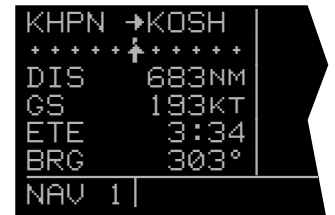

Figure 3-98

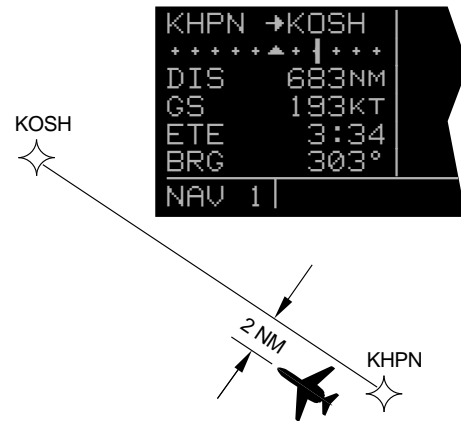

Figure 3-99

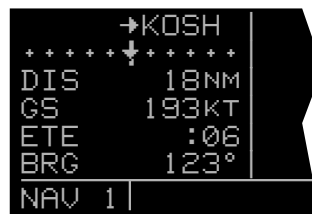

Figure 3-100



Figure 3-101

3.9.2 The Super NAV 1 Page

When the NAV 1 page is selected on both the left and right sides at the same time, the Super NAV 1 page is displayed (figure 3-102). The Super NAV 1 page contains exactly the same information as the standard NAV 1 page but spreads the data out across the entire screen making it even easier to view. The word “**FLAG**” is displayed over the CDI when the KLN 90B is not usable for navigation.



Figure 3-102

3.9.3 The Navigation 2 Page (NAV 2)

The NAV 2 page in figure 3-103 displays the aircraft's present position in two formats. The first format is in terms of the distance and radial from a nearby VOR. (Although terminal VORs are in the database, they are not used on this page since many aeronautical charts do not display a compass rose around them for orientation purposes). The second format is in latitude and longitude.

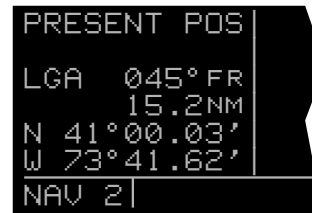

Figure 3-103

NOTE: When flying non-precision approach procedures that contain DME arcs, the VOR/DME station that defines the arc is always displayed on the NAV 2 page even if the reference is a terminal VOR/DME. This occurs when the aircraft is within 30 NM of the arc.

3.9.4 The Navigation 3 Page (NAV 3)

The NAV 3 page, such as shown in figure 3-104, displays the following supplementary navigation information:

- Desired track (**DTK**) - The great circle course between two waypoints. Any CDI or HSI driven by the KLN 90B, including the CDI displayed on the NAV 1 page, is referenced to this DTK. You may wish to view the navigation terminology diagram in Appendix A at this time if you are unfamiliar with terms like desired track and actual track.

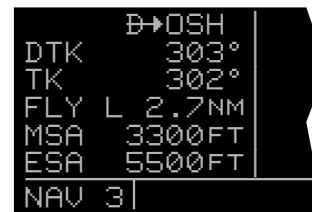

Figure 3-104

NOTE: If the KLN 90B is in the OBS mode, the selected course (OBS) is displayed instead of the desired track on the NAV 3 page (figure 3-105).

- Actual track (**TK**) - The aircraft's present track over the ground. Note: If there is insufficient velocity, the KLN 90B will display dashes (- - -) instead of the actual track.
- Cross track error correction - This is a text means of indicating how far and which direction to get back on course. It is consistent with the vertical deviation bar displayed on the NAV 1 page. “**FLY L 2.7 NM**” means fly left 2.7 nautical miles to get on course.

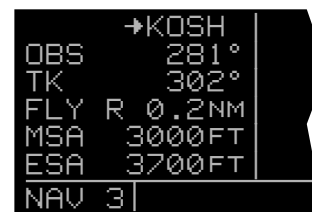

Figure 3-105

- Minimum Safe Altitude for present position (**MSA**) - **IMPORTANT:** The minimum safe altitude displayed is the altitude defined by Jeppesen as “Grid Minimum Off-Route Altitude (Grid MORA)”. This altitude is derived by Jeppesen for sectors which are one degree of latitude by one degree of longitude in size. One degree of latitude is 60 nautical miles. One degree of longitude is 60 nautical miles at the equator and progressively less than 60 nautical miles as one travels away from the equator. One degree of longitude is approximately 50 nautical miles at the southern most parts of the U.S. and is approximately 40 nautical miles at the northern most parts of the U.S. The MSA altitude information is contained in the database and is updated when the database cartridge is updated.

The minimum safe altitude (**MSA**) provides “reference point” clearance within these one degree latitude by one degree longitude sectors. Jeppesen defines a reference point as “a natural (Peak, Knoll, Hill, Etc.) or man-made (Tower, Stack, Tank, Building, etc.) object”. Jeppesen states the following about the Grid Minimum Off-Route altitude: “Grid MORA values

clear all reference points by 1000 feet in areas where the highest reference points are 5000 feet MSL or lower. MORA values clear all reference points by 2000 feet in areas where the highest reference points are 5001 feet MSL or higher”. The KLN 90B displays dashes for areas outside the database coverage area or for areas where the Grid MORA is not defined.

- Minimum Enroute Safe Altitude (**ESA**). **IMPORTANT:** When the KLN 90B is in the Leg mode, the minimum enroute safe altitude is the highest MSA sector altitude from the present position to the active waypoint, then to the destination waypoint along the active flight plan. See figure 3-106. When the KLN 90B is in the OBS mode, the minimum enroute safe altitude is the highest MSA sector altitude from the present position to the active waypoint.

WARNING: The MSA and ESA altitudes displayed are advisory in nature only. They should not be relied upon as the sole source of obstacle and terrain avoidance information. Refer to current aeronautical charts for appropriate minimum clearance altitudes.

MINIMUM ENROUTE SAFE ALTITUDE (ESA)

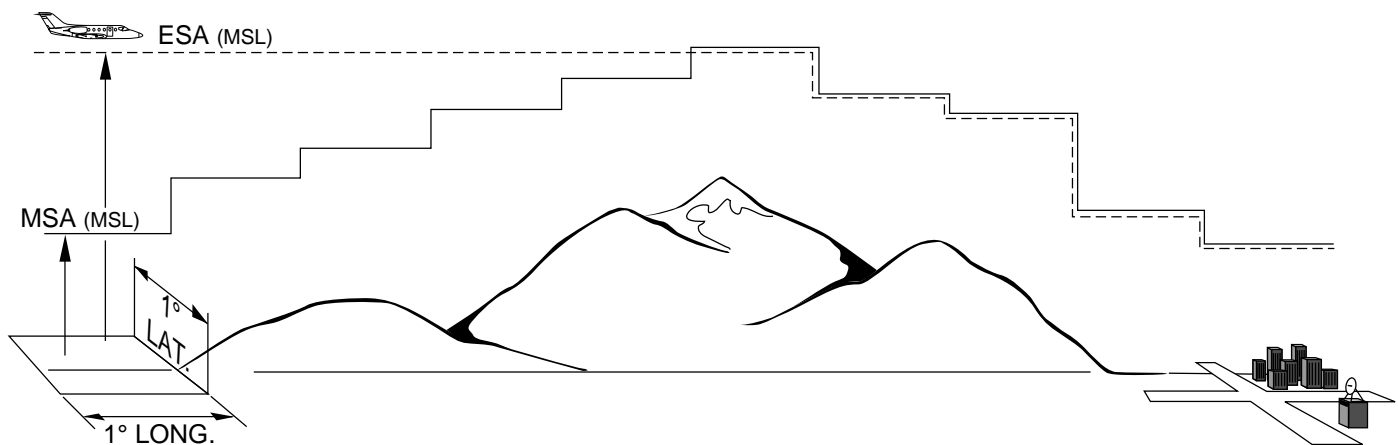

Figure 3-106

3.9.5 The Navigation 4 Page (NAV 4)

The NAV 4 page (figure 3-107) is used for altitude alerting and for advisory vertical navigation (VNAV). The operation of altitude alerting is described in section 3.15 and the operation of VNAV is described in section 5.2.

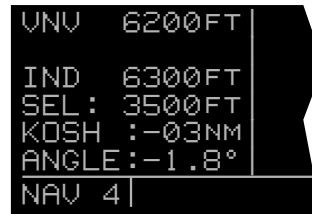

Figure 3-107

3.9.6 The Navigation 5 Page (NAV 5)

The NAV 5 page provides a navigation graphics presentation. It is useful in providing you with proper orientation of the navigation situation. In all KLN 90B installations there are three common map orientation formats that may be selected on the NAV 5 page: a True North up display, a desired track up display, or an actual track up display. In addition, if the KLN 90B is interfaced with a source of heading in a compatible format then a heading up presentation may also be selected. When the North up display is selected, viewing the NAV 5 page is like looking at a navigation chart with North at the top. When the desired track up display is selected, viewing the NAV 5 page is like looking at a chart that is turned so that your course line is always pointing up. When the actual track up display is selected, viewing the NAV 5 page is like looking at a chart that is turned so that the direction the aircraft is tracking over the ground is pointing up. In a no wind condition, actual track is identical to the aircraft's heading.

CAUTION: When using the actual track up format it is typical for there to be a slight delay from the time a heading change is made until the correct map orientation is displayed. Be careful when using either the desired track up display or the actual track up display to not think that a heading up display is being used.

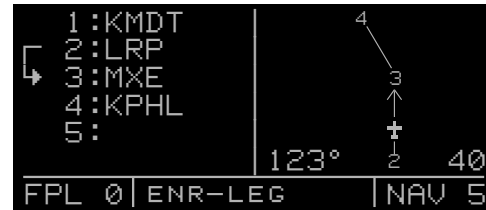

Figure 3-108

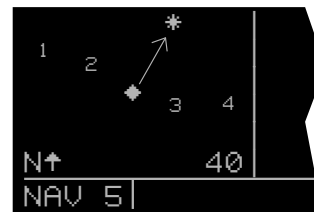

Figure 3-109

In chapter 4 of this Pilot's Guide you will learn to use flight plan operation where the NAV 5 page really becomes useful. When navigating using flight plan operation, the active flight plan (FPL 0) waypoints are displayed using the number associated with the waypoint as it appears on the FPL 0 page (figure 3-108). Thus, the position of the third waypoint in FPL 0, MXE, is indicated by a 3 on the NAV 5 page. Lines connect the flight plan waypoints. An arrow points to the active waypoint and shows the current flight plan leg.

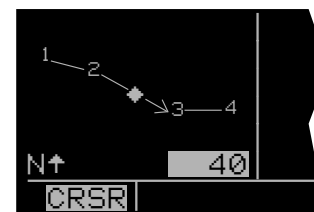

Figure 3-110

When operating Direct To a waypoint which is not in the active flight plan the Direct To waypoint is indicated on the NAV 5 page by an * (figure 3-109).

To select the desired NAV 5 orientation, press the appropriate █ (left █ if NAV 5 page is on left side and vice versa). The cursor will be over the map range scale (figure 3-110). Turn the appropriate outer knob one step counterclockwise to position the cursor over the map orientation field (figure 3-111). Rotate the appropriate inner

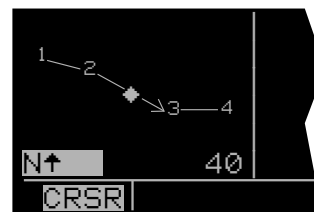

Figure 3-111

knob to display **Nt** for North up, **DTKt** for desired track up (figure 3-112), **TKt** for actual track up (figure 3-113), or **HDGt** for heading up (figure 3-114). The heading up selection is not presented as a choice if heading is not provided to the KLN 90B. If the cursor is moved to the map range scale using the outer knob or if the cursor is turned off with the **■** button, then the **DTKt**, **TKt**, or **HDGt** announcement is replaced with the actual value. The **123 °** displayed in the lower left corner of figure 3-115 shows how the actual track is displayed when the cursor is not over the map orientation field as it was in figure 3-113.

If a heading input is available to the KLN 90B then heading up is usually the best map orientation to select. Otherwise, track up display is usually preferred for use in flight. However, the track up display is only usable when the aircraft is moving 2 knots or more so the North up display may be a good choice while operating with very slow ground speeds.

Notice that in both the North up format and the desired track up format, the aircraft's position is depicted by a diamond. In the actual track up format and the heading up format, the aircraft's position is depicted by an aircraft symbol.

The range scale is displayed in the lower right corner of the NAV 5 page. The range scale indicates the distance from the aircraft's position (the diamond or aircraft symbol) to the top of the screen. Range scale selections from 1 NM to 1000 NM may be made by pressing the appropriate **■** and turning the appropriate inner knob. For example, figure 3-116 illustrates the results of changing the range scale of the map in figure 3-110 from 40 nautical miles to 15 nautical miles.

When the NAV 5 page is displayed on the left side of the screen and any selected waypoint page is displayed on the right side, the location of the selected waypoint is indicated by a **+** on the NAV 5 page (figure 3-117). Of course, the display scale must be chosen which allows the selected waypoint to be displayed.

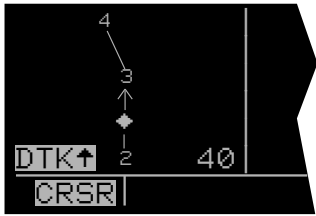

Figure 3-112

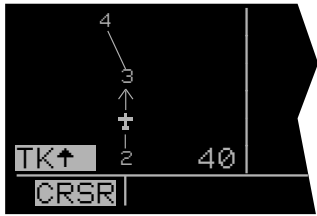

Figure 3-113

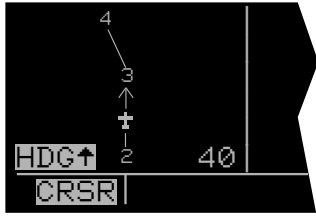

Figure 3-114

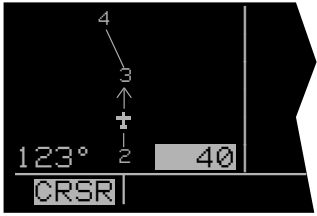

Figure 3-115

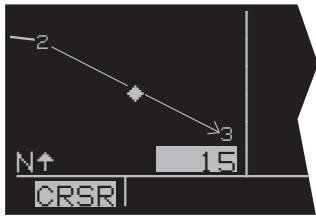

Figure 3-116

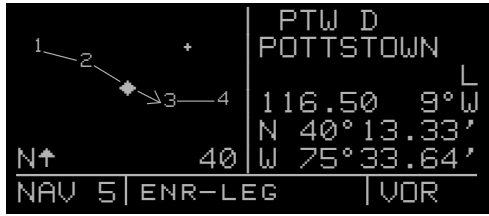

Figure 3-117

3.9.7 The Super NAV 5 Page

Regardless of whether you ultimately learn to use just the Direct To capabilities of the KLN 90B or whether you master all of its sophisticated features, you will definitely want to learn how to use the Super NAV 5 page! The Super NAV 5 page provides you with a true moving map display of your present position and route of flight in relation to nearby navaids and airports. The Super NAV 5 page is displayed by selecting the NAV 5 page on both the left and right sides at the same time (figure 3-118). As you can see, the Super NAV 5 page has a unique format unlike any other KLN 90B page. This is done so that you get the maximum amount of screen dedicated to graphics display. There are no page display indicators in the lower left and right segments of the display to tell you the Super NAV 5 page is being displayed. However, you will soon learn to recognize the Super NAV 5 page by its unique format. The mode annunciation, which normally appears in the lower center segment of the screen, is now located on the far left side. The message prompt is now located in the lower left corner of the graphics display.

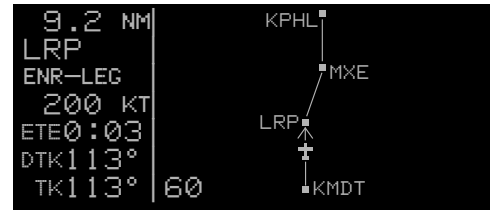

Figure 3-118

The left side of the Super NAV 5 page shows the following information:

- Distance to the active waypoint
- The active waypoint identifier
- Mode of operation
- Groundspeed
- *Estimated time enroute, cross track error, or VNAV status
- *Desired track, bearing to active waypoint, or radial from active waypoint
- *Actual track, bearing to active waypoint, or radial from active waypoint

The lines above with an * in front can be configured by the pilot to display any of the items listed. This is done by pressing the left **■** and rotating the left outer knob counterclockwise until it is over the desired line. Turn the left inner knob to choose between items for a given line. When all selections are complete, turn off the cursor by pressing the left **■**.

The map scale is also changed by using the left cursor button. To change the map scale, press the left **■** to place the cursor over the map scale factor at the bottom left corner of the map display. Turn the left inner knob to select a map scale. The map scale choices are the same as for the NAV 5 page except there is an additional choice, AUTO, that is located between the 1 and 1000 nm scale factors. The AUTO scale factor will automatically choose the smallest map scale that will display the active waypoint and, if there is one, the waypoint after the active waypoint. Choosing the AUTO scale factor means there is one less item for you to worry about. This is especially helpful when conducting non-precision approaches using the KLN 90B.

Like the NAV 5 page, the Super NAV 5 page shows a graphics depiction of the direct to waypoint or the waypoints making up the active flight plan. But surprise number one is that the Super NAV 5 page shows alphanumeric waypoint identifiers on the graphics display to make orientation even easier for you.

Now surprise number two. You may elect to have nearby VORs, NDBs, and/or airports added to the graphics display! To do so, press the right **■** to display a pop up menu on the right side of the screen (figure 3-119). Notice from the menu that a circle with a dot in the center represents a VOR, a smaller circle represents a NDB, and a small diamond represents an airport. The VORs, NDBs, and airports displayed are those from the nearest waypoint lists described in section 3.7.3, "Nearest and Complete Waypoint Scan Lists."

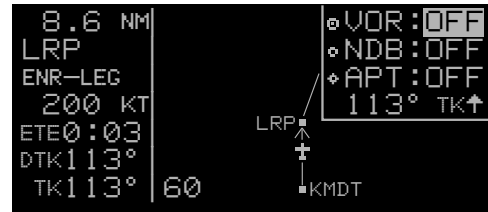

Figure 3-119

When the menu is first displayed the cursor will be on the VOR selection field. Rotate the right inner knob to display one of the following: **TLH**, **LH** (figure 3-120), **H**, or **OFF**.

TLH Terminal, low altitude, and high altitude VORs are selected. In addition, VORs of undefined class will be displayed. In some parts of the world VORs are not classified into one of the three standard classes: therefore, TLH must be selected to display these undefined class VORs.

LH Only low altitude and high altitude VORs will be displayed.

H Only high altitude VORs will be displayed.

OFF No VORs displayed

In a like manner NDBs and/or airports may be selected by first using the right outer knob to move the cursor over the **NDB** or **APT** selection field and then using the right inner knob to select **ON** or **OFF**. The example in figure 3-121 shows low and high altitude VORs as well as NDBs having been selected. Notice that the range scale has been changed from 60 nm to 40 nm.

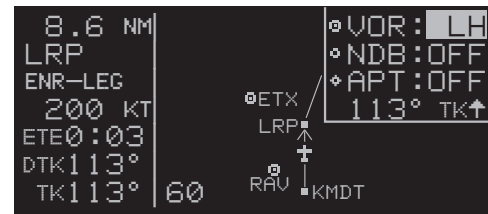

Figure 3-120

The map orientation can be changed by moving the cursor to the bottom line of the pop-up menu and rotating the right inner knob. The map orientation choices are the same as for the NAV 5 page: North up, desired track up, actual track up, or heading up (if a proper source of heading is provided). Remember that for actual track up, graphics are displayed only when the aircraft's ground-speed is greater than 2 knots.

When the desired selections have been made, press the right **■** to remove the menu (figure 3-122).

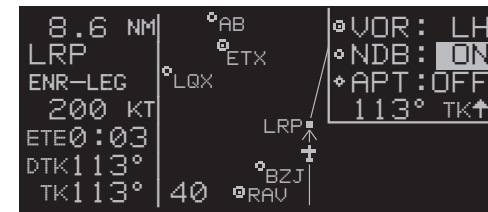

Figure 3-121

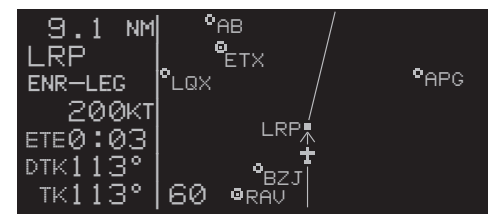

Figure 3-122

The last surprise for this page is that it is possible for you to change the active waypoint to any of the flight plan waypoints without having to leave this very useful page. This is done by pulling on the right inner knob to place it in the “out” position. This will create a “window” at the bottom right corner of the display that will initially contain the active waypoint in reverse video (figure 3-123). The waypoint contained in this “window” will be the default waypoint when **[REDACTED]** is pressed. By turning the right inner knob it is possible to scan through the waypoints of the active flight plan. Turning the knob clockwise will scan through the waypoints in sequence until the end of the flight plan is reached. Turning the knob counter-clockwise will scan through the active flight plan in reverse order until the beginning of the flight plan is reached. Pushing the right inner knob back to the “in” position will remove the “window” from the graphics portion of the display. An example of how to use this technique is presented in section 4.3.2.

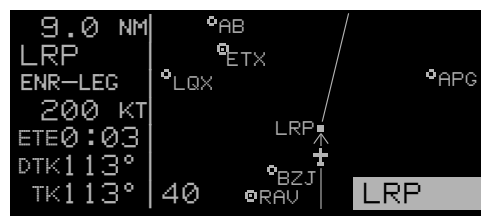

Figure 3-123

The following operational hints will make using the Super NAV 5 more enjoyable.

- It is easy to clutter the display with so much data that it is unusable. Select a range scale that allows an uncluttered presentation of the chosen VORs, NDBs, and airports. Or, select another combination of VORs, NDBs, and airports from the menu. Experiment and continue to make new selections for different phases of your trip. For example, you may find that in the enroute part of the flight selecting high altitude VORs provide you with enough information, while in the terminal area you select a smaller range scale and select more items.
- Press **[REDACTED]** to instantly declutter the VOR, NDB, and airport selections from the graphics display. Flight plan and Direct To waypoints will still be displayed. Press **[REDACTED]** again to restore the selections.
- While taxiing on the airport or flying in the traffic pattern, select the 1 NM or 2 NM scale to display the airport runway diagram instead of the usual airport diamond symbol. All runway designations are shown on the 1 NM scales (figure 3-124). If the 2 NM scale is selected, then the runway designations are shown only for the longest runway. If your KLN 90B is not provided a heading input you may wish to select a North up display while the aircraft is on the airport since an actual track up graphics presentation can only be displayed when the aircraft is moving at least 2 knots.

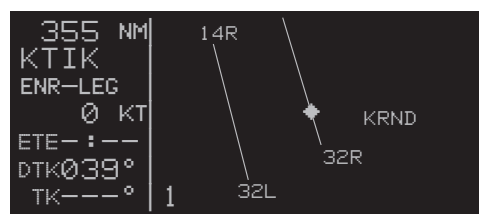

Figure 3-124

CAUTION: The NAV 5 and Super NAV 5 pages do not display weather, terrain, special use airspace, or other data.

3.10 SPECIAL USE AIRSPACE ALERT

The KLN 90B database contains the location of areas of special use airspace (SUA). The types of SUA areas stored in the database and the abbreviations used to denote these areas are the following:

Class B	CL B
Class C	CL C
Control Area (used outside USA)	CTA
Terminal Area (used outside USA)	TMA
Alert Area	ALRT
Caution Area	CAUT
Danger Area	DNGR
Military Operations Area	MOA
Prohibited Area	PROH
Restricted Area	REST
Training Area	TRNG
Warning Area	WARN

The KLN 90B will normally alert you prior to entering one of these areas with a message prompt. When the Message page is viewed it will display **AIRSPACE ALERT** and will also display the name and type of the special use airspace (figure 3-125). If the special use airspace is a Class B, Class C, CTA, or TMA, the message page will also instruct you to see the Airport 4 page (airport communications) for the primary airport so that the correct communications frequency may be determined (figure 3-126).

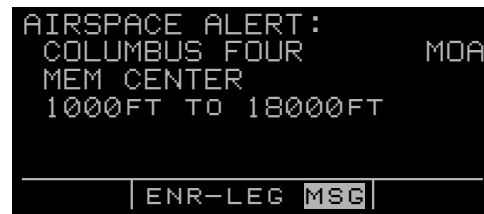

Figure 3-125

The SUA alert feature is three dimensional. The SUA areas are stored in the KLN 90B database with regard to altitude when the actual SUA altitude limitations are charted in terms of mean sea level (MSL). Therefore, if you are flying either above or below an SUA area you won't be inconvenienced with nuisance alert messages. However, if the actual lower limit of a SUA is charted in terms of an altitude above ground level (AGL), then it is stored in the KLN 90B as all altitude below the upper limit of the SUA. If the actual upper limit of an SUA is charted in terms of AGL, it is stored in the KLN 90B as "unlimited".

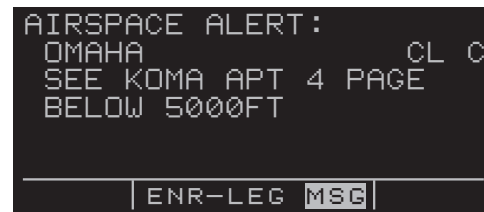

Figure 3-126

If the altitude input to the KLN 90B is pressure altitude from an altitude encoder or air data computer, then you must manually update the KLN 90B with an altimeter setting (baro correction) in order to receive accurate SUA alerting. You may easily update the altimeter setting by pressing the **■** button to display the Altitude page (figure 3-127). The cursor will be over the inches field if "inches" was previously selected on the SET 7 page. If "millibars" was selected on the SET 7 page then the cursor will be over the first two digits of the millibar field. The left inner knob is used to change the digits and the left outer knob is used to move the cursor to the desired position. When the altimeter setting is complete, press **■** to return to the pages previously in view.

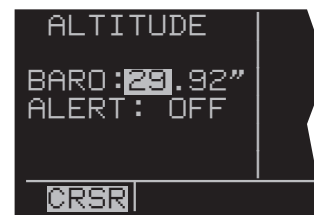

Figure 3-127

CAUTION: Failure to keep the altimeter baro setting updated will result in inaccurate special use airspace alerting. If this feature is used, it is a good idea to

update the altimeter baro setting on the ALT page each time you make a change to an aircraft's altimeter setting.

NOTE: If there is no altitude input to the KLN 90B, all altitudes will be regarded as being within the boundary of the SUA area.

Only the outer lateral boundaries are stored for Class B, Class C, CTA, and TMA airspace. These SUA areas are stored as "cylinders" of airspace so all altitudes below the upper limit of these areas are considered to be in the SUA.

The message prompt for a special use airspace alert will occur when the aircraft's position is at a point such that a projection of the aircraft's existing track over the ground is approximately 10 minutes from penetrating the outer boundary of one of these areas. It will also occur if the aircraft is within approximately two nautical miles of one of these areas even if the aircraft's projected track over the ground won't actually penetrate the SUA area (figure 3-128). If one of the SUA areas is penetrated, another message will state: **INSIDE SPC USE AIRSPACE.**

SPECIAL USE AIRSPACE ALERT



Figure 3-128

The SUA alert feature may be disabled (or enabled) on the Setup 8 (SET 8) page, shown in figure 3-129. After displaying the SET 8 page on the left side, press the left **■** to turn on the left cursor function. The left inner knob is used to display **AIRSPACE ALERT ENABLE** or **AIRSPACE ALERT DISABLE**.

If the SUA alert feature has been enabled, the KLN 90B allows you to select a vertical buffer on the SET 8 page (figure 3-130) in order to provide an additional layer of protection from inadvertently entering a SUA area. To select a vertical buffer, make sure the SUA alert feature has been enabled. Press the left **■** to turn on the left cursor and then use the left outer knob to move the cursor over the first position of the vertical buffer (figure 3-131). Use the left outer knob to position the cursor and the left inner knob to select each number (figure 3-132). The buffer may be selected in one hundred foot increments. After the desired selection has been made, press the left **■** to turn off the cursor function.

The vertical buffer serves to “stretch” the SUA area in both directions by the selected buffer altitude. For example, let’s say you have selected a buffer of 1000 feet and the actual SUA area exists from 5,000 feet MSL to 12,000 feet MSL. In this case you will receive SUA alert messages if you fly at any altitude between 4,000 and 13,000 feet MSL.

CAUTION: It is the pilot’s responsibility to avoid those areas of special use airspace where ATC clearance to penetrate is required but has not been obtained. The KLN 90B’s special use airspace alert is only a tool to assist the pilot and should never be relied upon as the sole means of avoiding these areas.

NOTE: Special Use Airspace alerting is disabled when in the approach arm or approach active modes.

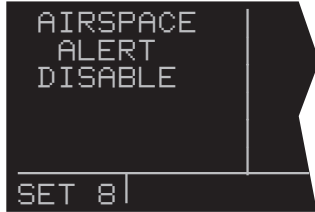

Figure 3-129

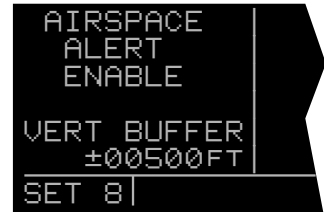

Figure 3-130



Figure 3-131



Figure 3-132

3.11 VIEWING THE WAYPOINT PAGES

You learned in section 3.7, "SELECTING WAYPOINTS", the different means of selecting the desired waypoint. You will now see what information may be displayed for each of the waypoint types (airport, VOR, NDB, intersection, and supplemental).

3.11.1 Airport Pages

There are eight airport pages (APT 1, APT 2, ..., APT 8) for every airport in the published database. The database primary area contains public use and military airports that have a runway at least 1000 feet in length (see section 2.2, "Database Coverage Areas and Contents"). We will use Orlando Executive airport to illustrate what is contained on the airport pages.

3.11.2 The Airport 1 Page (APT 1)

See figure 3-133.

- Airport identifier. An arrow precedes the identifier if it is the active waypoint.
- Airport name.
- If the airport underlies the outer boundary of a Class B or C airspace, CTA (Control Area - used outside USA), or TMA (Terminal Area - used outside USA), the letters **CL B**, **CL C**, **CTA**, or **TMA**, respectively, will appear on the left side of this line. Note that there is no altitude information applied to this criteria.

In addition, if the airport is a military airport the letters **MILTRY** will appear on the right side of this line. If the airport is a private airport, the letters **PRIVAT** will appear.

- The latitude and longitude of the airport reference point (the "official" location of the airport).

As shown in figure 3-134, the APT 1 page has a different format when it is displayed as one of the nine nearest airports (see section 3.7.3 "Nearest And Complete Waypoint Scan List" and section 3.7.3.1 "Nearest Airports In An Emergency").

- To the right of the airport identifier are the letters "NR" followed by a number designating the nearest airport (**NR 1**), second nearest airport (**NR 2**), etc. to the aircraft's present position.
- The length, surface, and lighting of the longest runway.
- The bearing and distance to the airport.



Figure 3-133

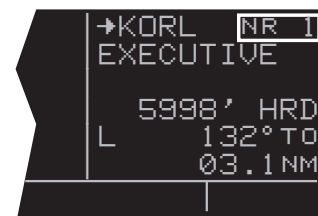

Figure 3-134

3.11.3 The Airport 2 Page (APT 2)

See figure 3-135.

- Airport identifier. An arrow precedes the identifier if it is the active waypoint.
- The city where the airport is located.
- The state if the airport is located in the United States, the Province if located in Canada, or the country outside the United States and Canada. A listing of the abbreviations used for States, Provinces, and countries is contained in Appendix D.
- Airport elevation. The elevation is rounded to the nearest 10 feet.
- Time in relationship to UTC (Zulu). **Z-05**, for example, indicates local standard time is five hours behind UTC time. If the airport is located in an area which observes daylight savings time, the information in parentheses shows the daylight savings time in relationship to UTC.
- Instrument approach information.

- ILS** - airport has an ILS approach.
- MLS** - airport has an MLS approach.
- ILS/MLS** - airport has ILS and MLS approaches.
- NP APR** - airport has a non-precision approach and no ILS or MLS.
- NO APR** - airport does not have an instrument approach.

- The symbol **(R)** designates that the airport is serviced by an Approach/Departure control facility having radar capability. If you are on an instrument flight plan, you know whether to expect vectors to the final approach course or whether you will have to do your own transition. If you are VFR, you know whether or not the Approach/Departure control is capable of providing separation advisories.

3.11.4 The Airport 3 Page (APT 3)

The function of the APT 3 page is to display runway information for the selected airport. For many airports the first APT 3 page depicts a North up runway diagram for the airport as shown in figure 3-136 for **KORL**.

NOTE: This runway diagram is present only for those airports where Jeppesen's data contains the position of the runway thresholds.



Figure 3-135

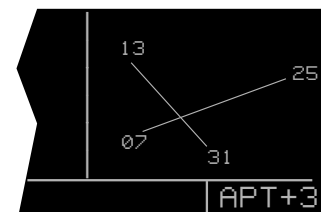

Figure 3-136

The primary APT 3 page (figure 3-137) follows the runway diagram. Runway designation, lighting, and types of surface for up to five runways are displayed in order of length, beginning with the longest. Since there are many times when all of an airport's runway information does not fit on one page, additional APT 3 pages are used to display the data. Remember that a "+" inserted between the page type and the number (**APT+3** in this case) is used to indicate that there is more than one Airport 3 page.

```

+KORL
RT 25 31
07 /25 L
5998' HRD
13 /31 L
4638' HRD
APT+3
  
```

Figure 3-137

- The letters "RT" followed by a runway designation indicate that the runway normally has a right hand traffic pattern. In figure 3-137, **RT 25 31** designates that runways 25 and 31 have a right hand traffic pattern.
- Runway number designation for both ends of the runway.
- Runway lighting availability.
 - L** - runway lighting sunset to sunrise
 - LPC** - runway lighting is pilot controlled
 - LPT** - runway lighting is part-time or on-request
 - blank indicates no runway lighting
- Runway length in feet.
- Runway surface:
 - HRD** - hard surface (includes asphalt, concrete, pavement, sealed, tarmac, brick, and bitumen)
 - TRF** - turf
 - GRV** - gravel
 - CLY** - clay
 - SND** - sand
 - DRT** - dirt
 - ICE** - ice
 - MAT** - steel matting
 - SHL** - shale
 - SNW** - snow
 - Blank indicates runway surface type is unknown.

In the event that there is no runway information for an airport, the following message is displayed on the APT 3 page:

RUNWAY DATA NOT AVAILABLE

3.11.5 The Airport 4 Page (APT 4)

See figure 3-138

The APT 4 page is used to display communication frequencies for the selected airport.

- Airport identifier. An arrow precedes the identifier if it is the active waypoint.
- Frequencies for:
 - ATIS** - automatic terminal information service
 - PTAX** - pre-taxi clearance
 - CLR** - clearance delivery
 - GRND** - ground control
 - RAMP** - ramp/taxi control
 - TWR** - tower
 - UNIC** - unicom
 - MCOM** - multicom
 - CTAF** - common traffic advisory frequency
 - RDO** - radio
 - MF** - mandatory frequency
 - ATF** - aerodrome traffic frequency
 - AFIS** - aerodrome flight information service
 - CL B** - Class B (VFR frequency)
 - CL C** - Class C (VFR frequency)
 - TRSA** - terminal radar service area (VFR frequency)
 - CTA** - control area (VFR frequency used outside USA)
 - TMA** - terminal area (VFR frequency used outside USA)
 - APR** - approach control
 - DEP** - departure control
 - CTR** - center (when center is used for approach/departure control)
 - ARVL** - arrival
 - RDR** - radar only frequency
 - DIR** - director (approach control/radar)
 - ASOS** - automated surface observation system
 - AWOS** - automatic weather observing station
 - AAS** - aeronautical advisory service
 - PCL** - pilot controlled lighting



Figure 3-138

In addition to the standard VHF frequencies shown in figure 3-138, HF frequencies are shown at airports that utilize “high frequency” communications that fall in the 2000 kHz to 30,000 kHz frequency band. These are typically used in remote areas of the world. One way to tell HF frequencies is that they do not contain a decimal point. A display of **6547** would indicate a frequency of 6,547 kHz.

Airports which have numerous communication frequencies will have multiple Airport 4 pages indicated by **APT+4**.

Part-time operation, such as for a control tower, is indicated with an * to the left of a frequency.

The frequencies associated with CL B, CL C, TRSA, CTA, or TMA are VFR frequencies. Airports which have one of these categories of frequencies also have APR and DEP which are IFR frequencies.

Where required, APR, DEP, CL B, CL C, TRSA, CTA, and TMA frequencies are sectorized. That is, a frequency may be used only within a certain range of radials from a designated reference location. The format for displaying the sectorization is to show the frequency first, followed by the identifier of the associated reference point, followed next by the associated altitude restrictions. For example, figure 3-139 shows that the Orlando approach control frequency 121.10 MHz is used between the 311° radial and the 60° radial from KMCO (Orlando International airport) for altitudes at and below 5500 feet.

NOTE: When an altitude restriction is shown on the Airport 4 page, the abbreviation **BEL** means at and below the specified altitude. Likewise, the abbreviation **ABV** means at and above the specified altitude. Thus, **ABV 4000FT** means at and above 4000 feet and **BEL 3999ft** means at and below 3999 feet.

In a few cases, APR, DEP, CL B, CL C, TRSA, CTA, and TMA frequencies are sectorized such that the restriction cannot be displayed on a single page. When this occurs the following message is displayed on the APT 4 page:

TEXT OF FREQUENCY USAGE NOT DISPLAYED

There are also some airports in the database for which no communications information is available. The following message is then displayed on the **APT 4** page:

COMM FREQ DATA NOT AVAILABLE

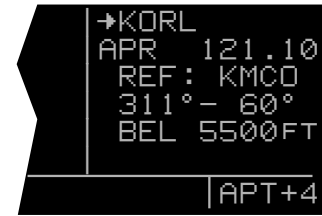

Figure 3-139

3.11.6 The Airport 5 Page (APT 5)

The Airport 5 page is used to store and display user-entered remarks. These remarks might include information on lodging, dining, airport services, or anything else you desire to record for later use. Up to 100 airports may contain these remarks. A remark may contain up to three lines of eleven characters each. Letters, numbers, hyphens, and spaces may be used in the remark. To enter a remark:

- Select the APT 5 page for the desired airport (figure 3-140).
- Press the right **■**.
- Rotate the right outer knob until the cursor fills the entire third line of the screen (figure 3-141).
- Use the right inner knob to select the first character of the remark.
- Use the right outer knob to move the flashing portion of the cursor to the second cursor position, and then use the right inner knob to select the second character.
- Use the right outer and inner knobs to select the rest of the first line of the remark (figure 3-142).
- Press **■** to approve the first line. The cursor will move to the next line (figure 3-143).
- Use the above procedure to select the characters for the second and third lines of the remark. Press **■** to individually approve each line of the remark.
- Press the right **■** to turn the right cursor function off (figure 3-144).

The Other 4 page (**OTH 4**) includes a listing of all airports whose APT 5 pages contain remarks (figure 3-145). To delete a previously entered airport remark, select the Other 4 page, position the left cursor over the desired airport identifier, press **■**, and then press **■**. If there are more than five airports with remarks, you will have to use the left outer knob to scroll the cursor down the list on the Other 4 page to find the desired airport identifier.



Figure 3-140

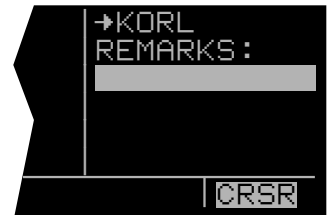

Figure 3-141



Figure 3-142



Figure 3-143



Figure 3-144



Figure 3-145

3.11.7 The Airport 6 Page (APT 6)

The APT 6 page shows aeronautical services available for the selected airport. These services include customs, fuel, and oxygen availability as well as an indicator to denote the presence of a landing fee. Refer to figure 3-146.

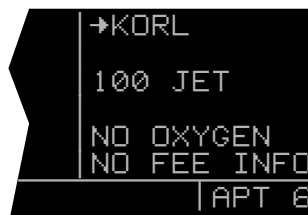

Figure 3-146

- Customs information is displayed as follows:

CUSTOMS-FULL	Customs facilities are available without restriction
NO CUSTOMS	No customs facilities are available
CUSTOMS-PR	Customs facilities are available but require prior request or permission for use
CUSTOMS-REST	Customs facilities are available on a restricted basis, check with the airport before planning to use
CUSTOMS-ADCS	Customs are available for private aircraft arriving to the U.S. from Canada or Mexico. Advance notice of arrival to customs officers is to be included in the flight plan transmitted to an FAA facility. This code is used when this is the only type customs facility available. The FAA term for the service is "ADCUS".
(blank)	Blank line indicates that customs information is not available in the database.

- The following fuel types are displayed:

80	80 octane
100	100 octane
100LL	100 octane, low-lead
MOGAS	Automotive fuel
JET	Jet fuel (any type jet fuel qualifies)
NO FUEL	No fuel available

- If there are no oxygen services available at the selected airport, the fifth line will display NO OXYGEN. If any type of oxygen service is available, the fifth line will read OX and the rest of the line will display the specific oxygen service:

H	high-pressure
HB	high-pressure bottled
L	low-pressure
LB	low-pressure bottled
ALL	all of the above oxygen services available

- The sixth line of the APT 6 page denotes the presence of a landing fee:

LANDING FEE	The airport has a landing fee
NO LDG FEE	The airport does not have a landing fee
NO FEE INFO	Jeppesen does not have any information on whether or not there is a landing fee for this airport

3.11.8 The Airport 7 Page (APT 7)

The APT 7 page shows the SID and STAR procedures that are available for the selected airport. If both SID and STAR procedures are available then there will be two APT 7 pages indicated by **APT+7** (figure 3-147). If there are no SID or STAR procedures in the database then this page will be as shown in figure 3-148.

The details of this page are presented in section 6.2.



Figure 3-147



Figure 3-148

3.11.9 The Airport 8 Page (APT 8)

The APT 8 page shows the non-precision approaches that are available for the selected airport (figure 3-149). There is only one APT 8 page. If there are no approaches for this airport in the database then this page will be as shown in figure 3-150.

The details of this page are presented in section 6.1.

NOTE: If the KLN 90B is not installed to support non-precision approaches, then the APT 8 page will not be displayed.



Figure 3-149



Figure 3-150

3.11.10 The VOR Page

The VOR page shown in figure 3-151 for Blue Ridge VOR is used to illustrate the contents of a VOR page.

- VOR identifier. An arrow precedes the identifier if it is the active waypoint.
- The letter **D** appears following the VOR identifier if the VOR has DME capability.
- The name of the VOR.
- The class of VOR:
 - T** - terminal
 - L** - low altitude
 - H** - high altitude
 - U** - undefined
- The VOR frequency (MHz).
- The published magnetic variation of the VOR.
- The latitude and longitude of the VOR.

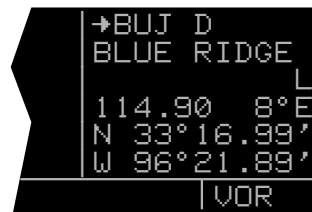

Figure 3-151

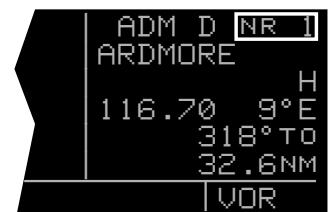

Figure 3-152

As you learned in section 3.7.3, "Nearest And Complete Waypoint Scan Lists", you may display the nearest nine VORs to the aircraft's present position. When a VOR page is displayed as part of the nearest VOR list, the latitude and longitude is replaced with the bearing and distance to the VOR (figure 3-152).

3.11.11 The NDB Page

The NDB page shown in figure 3-153 for Ottawa NDB is used to illustrate the contents of an NDB page.

- NDB identifier. An arrow precedes the identifier if it is the active waypoint.
- The name of the NDB.
- The NDB frequency (kHz).
- The latitude and longitude of the NDB.

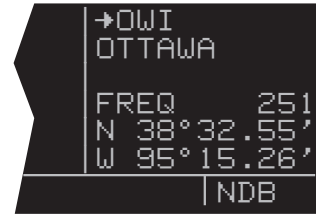

Figure 3-153

There is also a nearest NDB scan list as explained in section 3.7.3. When a NDB page is displayed as one of the nearest NDBs the latitude and longitude are replaced with the bearing and distance to the NDB (figure 3-154).

4.11.12 The Intersection Page (INT)

The Intersection pages contain the named low altitude, high altitude, approach, and SID/STAR intersections as well as outer markers and outer compass locators. The Intersection page for KENZY outer compass locator (figure 3-155) is used as an example of what is displayed for Intersection pages:

- The intersection, outer marker, or outer compass locator name.
- The location of the intersection, outer marker, or outer compass locator expressed in terms of a radial and distance from a nearby VOR. The KLN 90B chooses the closest VOR. Note that it takes a few seconds for the VOR ident, radial, and distance to be calculated and displayed.
- The latitude and longitude of the intersection, outer marker, or outer compass locator.

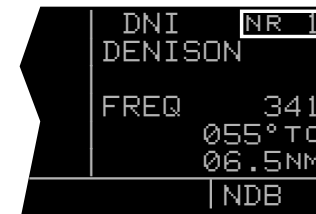

Figure 3-154

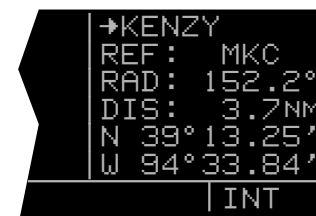

Figure 3-155

You may also enter the identifier of another nearby waypoint in the **REF** field, and the page will compute and display the radial and distance from the nearby waypoint to the intersection. This information is not stored with the Intersection page and is lost when leaving the page. To calculate the radial and distance from a nearby waypoint:

1. Display the desired Intersection page.
2. Press the right **■** to turn on the right cursor function.
3. Rotate the right outer knob until the cursor is positioned over the identifier adjacent to **REF** (figure 3-156).
4. Use the right inner and outer knobs to select the desired identifier (figure 3-157).

5. Press **■** to display the waypoint page for the identifier just entered.
6. Press **■** to approve the waypoint page. The Intersection page is displayed with the computed radial and distance (figure 3-158).
7. Press the right **■** to turn off the right cursor function.

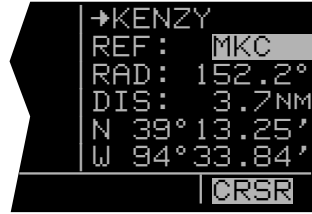

Figure 3-156

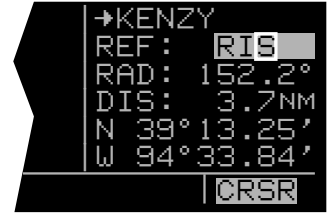

Figure 3-157

3.11.13 The Supplemental Waypoint Page (SUP)

Supplemental waypoints are user-defined waypoints that have not been defined specifically as an airport, VOR, NDB, or intersection. The procedure for creating supplemental waypoints is explained in section 5.4.4. Supplemental waypoints also include ARTCC “Center” waypoints and “Reference” waypoints which you will learn to create later in chapter 5 of this Pilot’s Guide. Figure 3-159 shows an example of a typical Supplemental Waypoint page. The following information is displayed on a Supplemental waypoint page:

- The name or identifier of the supplemental waypoint.
- The position of the supplemental waypoint expressed in terms of a radial and distance from a nearby VOR.
- The latitude and longitude of the supplemental waypoint.

In addition, you may enter the identifier of another nearby waypoint in the **REF** field and the page will compute and display the radial and distance from the nearby waypoint to the supplemental waypoint. The procedure for doing this is identical to that just explained above for an intersection waypoint. This radial and distance information is not stored with the Supplemental Waypoint page and is lost when leaving the page.



Figure 3-158

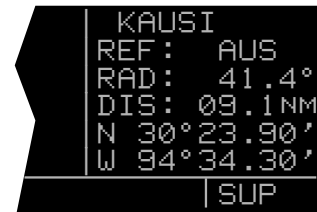

Figure 3-159

3.12 FREQUENCIES FOR NEAREST FLIGHT SERVICE STATIONS

The KLN 90B stores in its database the locations of Flight Service Stations (FSS) and their remote communications sites. In addition, the KLN 90B determines which two of these FSS points of communication are closest to your present location. What a convenience for you! Next time you want to file a flight plan from the air or contact a FSS for some other reason, you can easily use the KLN 90B to determine a suitable FSS and the appropriate frequency.

NOTE: In some areas of the world the KLN 90B provides the location of the nearest point of communication with a facility providing information (*INF*) or radio (*RDO*) services.

Select the Other 1 page (**OTH 1**) on the left side to view two of the nearest points of communication with Flight Service Stations. There will normally be two OTH 1 pages, one for each of the two points of contact. The name of the FSS is at the top of the page. There can be from one to four frequencies included for a point of contact (figure 3-160). Remember that in the U.S. the frequency 122.00 MHz is used for "Flight Watch" and the frequency 123.60 MHz is used for Aeronautical Advisory Service. As you know, it is often possible to communicate with a FSS by transmitting on 122.10 MHz and listening on the VOR frequency. In cases like this, the OTH 1 page displays the frequencies to use for transmit and receive and also the VOR name through which you are communicating (figure 3-161).

In some parts of the world, high frequency (HF) communications are used for these services. HF frequencies are displayed on the OTH 1 page where appropriate. Remember, you can easily recognize HF frequencies because they do not have a decimal point.

3.13 FREQUENCIES FOR AIR ROUTE TRAFFIC CONTROL CENTERS (ARTCC)

The KLN 90B also stores in its database the low altitude boundaries of each of the ARTCC "Centers". The KLN 90B determines the proper Center to contact and the appropriate frequencies to use for the aircraft's present position. The Other 2 page (**OTH 2**) is used to display this information to you (figure 3-162). Next time you wish to obtain VFR flight following or communicate with Center for any reason, you have a quick way to get a frequency for establishing contact! Appendix D contains a listing of Center abbreviations used on the OTH 2 page.

NOTE: Frequencies for Area Control Centers are displayed on the OTH 2 page for some areas of the world.

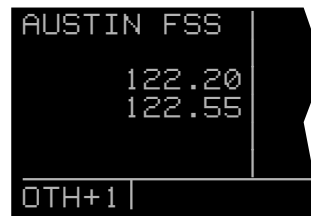

Figure 3-160

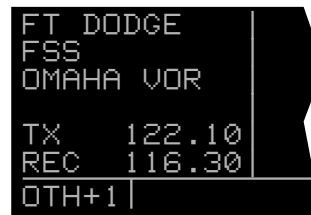

Figure 3-161

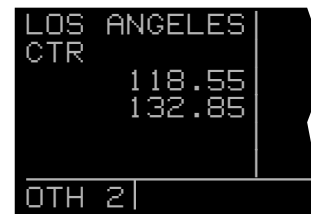

Figure 3-162

3.14 VIEWING AND SETTING THE DATE AND TIME

The KLN 90B system time and date should seldom, if ever, require updating because they are automatically updated when at least one satellite is received. In addition, the KLN 90B contains an internal battery powered calendar clock to keep system time and date when the unit is not being used. You will normally check to make sure the KLN 90B is set to the correct time and date shortly after you turn the unit on while you verify the Self Test Page. You can, however, also check the time and date on the Setup 2 page (**SET 2**) anytime you desire. There are several pages as well as some internal functions of the KLN 90B, such as magnetic variation and proper use of database information, that depend on having the proper time and date.

NOTE: You will not be able to update the time or date if the KLN 90B is receiving a time and date from a satellite.

If it is required to set the date:

1. Select the SET 2 page on the left side (figure 3-163).
2. Press the left **█** to turn on the left cursor function. The cursor will be over the entire date (figure 3-164).
3. Rotate the left inner knob to select the correct day of the month (figure 3-165).
4. Turn the left outer knob one step clockwise to position the flashing part of the cursor over the month field (middle three dashes).
5. Rotate the left inner knob to select the correct month (figure 3-166).
6. Turn the left outer knob one step clockwise to position the flashing part of the cursor over the first position of the year field (second dash from right).
7. Use the left inner knob to select the correct ten's digit of the year (figure 3-167).
8. Turn the left outer knob one step clockwise to position the flashing part of the cursor over the remaining position in the year field.
9. Use the left inner knob to complete the year.
10. Press **█** to start the KLN 90B using the new date (figure 3-168).

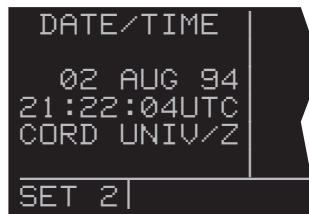

Figure 3-163



Figure 3-164



Figure 3-165

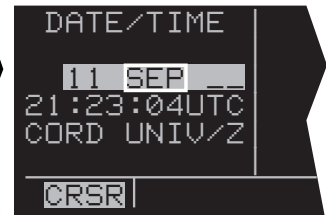

Figure 3-166



Figure 3-167



Figure 3-168

If it is required to set the time:

1. Select the SET 2 page on the left side.
2. Press the left **■** to turn on the left cursor function if it is not on already.
3. Use the left outer knob to position the cursor over the time zone (figure 3-169).
4. Use the left inner knob to change the time zone, if desired (figure 3-170). A listing of the time zones and their abbreviations is contained in section 3.2.
5. Turn the left outer knob one step counterclockwise to position the cursor over the time (figure 3-171).
6. Rotate the left inner knob to select the correct hour (figure 3-172). Remember, the KLN 90B uses 24 hour time. If it is 1:00 P.M. or later, add 12 hours (for example, 2:30 P.M. becomes 14:30).
7. Turn the left outer knob one step clockwise to position the flashing part of the cursor over the first minute's position, and then use the left inner knob to select the correct value (figure 3-173).
8. Turn the left outer knob one step clockwise again to position the flashing part of the cursor over the remaining minute's position, and then use the left inner knob to complete the time selection.
9. Press **■** to start the clock running (figure 3-174).
10. Press the left **■** to turn off the left cursor function.



Figure 3-169



Figure 3-170



Figure 3-171



Figure 3-172



Figure 3-173



Figure 3-174

3.15 ALTITUDE ALERTING

If your aircraft does not already have an altitude alerting capability you may wish to use the KLN 90B's capability of assisting you with altitude management during your flying. Altitude alerting allows you to select a target altitude and it then provides you with an aural alarm 1000 feet prior to reaching the selected altitude, another aural alarm upon reaching the selected altitude, and another aural alarm if you deviate from the selected altitude.

NOTE: The altitude alerting function of the KLN 90B does not meet FAR Part 91 for turbojet-powered civil airplanes.

To use the altitude alerting:

1. Press **ALT**. The Altitude page will be displayed on the left with the cursor over the first two digits of the altimeter baro set field. The NAV 4 page will be displayed on the right with the cursor over the first digit of the selected altitude field (figure 3-175).

NOTE: The altimeter baro set units may be changed from inches to millibars on the SET 7 page.

2. Use the left knobs to update the altimeter baro setting if required. There are three cursor positions. Use the left outer knob to move the cursor and the left inner knob to change digits (figure 3-176). With the proper altimeter baro setting, the indicated altitude (**IND**) on the right should be the same as the aircraft's actual altimeter.

NOTE: There may be some difference (less than 100 feet) between the indicated altitude (**IND**) and the aircraft's actual altitude if the altitude input to the KLN 90B is from an altitude encoder because these encoders only provide altitude in 100 foot increments.

3. Turn the left outer knob one step clockwise to position the cursor over the **ALERT:** field (figure 3-177). If **OFF** is displayed, turn the left inner knob to select **ON** (figure 3-178). When alerting is enabled, an arrow to the right of **ON** points to the selected altitude on the right side of the screen.
4. Select a warn altitude by using the left outer knob to position the cursor over the **WARN:** field (figure 3-179). Use the left inner knob to select the desired warn altitude. It is selectable in one hundred foot increments from 200 feet up to 900 feet. Normally, you will use the same warn altitude all the time so you only have to enter this the first time you use altitude alerting. The recommended warn altitude is 300 feet.



Figure 3-175



Figure 3-176



Figure 3-177



Figure 3-178



Figure 3-179

5. Enter the selected altitude one digit at a time in the **SEL** field of the NAV 4 page by using the right outer knob to position the cursor over the desired digit and the right inner knob to change the digits until the entire selected altitude is displayed (figure 3-180).

Only the selected altitude field (**SEL**) and the indicated altitude (**IND**) of the NAV 4 page are used for altitude alerting. The rest of the NAV 4 page is used for vertical navigation which is described in chapter 5.

6. Press **■** to return to the pages previously being displayed.
7. The aural alarm activates as follows:
 - 1000 feet prior to reaching the selected altitude - three short tones
 - Upon reaching the selected altitude - two short tones
 - Deviating above or below the selected altitude by more than the warn altitude - four short tones.

NOTE: Due to the resolution of the altitude input, it may be necessary to descend slightly below or climb slightly above the selected altitude before the two tones are activated indicating that the selected altitude has been reached. This selected altitude alert must be activated to arm the system for providing the altitude deviation alert.

The KLN 90B can provide the aural alarm tones in either of two ways: it may be connected to an audio input of an audio amplifier contained in an audio panel so that the aural alarm is heard through the aircraft's speaker and headphones. Or the KLN 90B may be interfaced with an external tone generator installed in the aircraft.

In order to use altitude alerting, the KLN 90B must have an altitude input. If the altitude input is from an altitude encoder or from an air data computer not having a baro altitude output, then it will be necessary for you to manually input the proper altimeter setting in order to get accurate alerting. Remember, the altitude coming from an encoder is pressure altitude and must be corrected with the proper altimeter setting to convert to actual altitude. This altimeter setting is easily accomplished by entering the altimeter baro setting on the Altitude page. Press **■** to display the Altitude page. Use the left knobs to make the altimeter baro setting. Press **■** again to return to the pages previously being displayed. It's so easy you have no excuses for not keeping the baro setting updated!

CAUTION: The altitude alerting feature will only be accurate if the altimeter baro correction is kept updated. If altitude alerting is used, it is a good idea to update the altimeter baro set on the ALT page each time you make a change to the aircraft's altimeter setting.



Figure 3-180

The volume of the aural alarm tone is changeable on the SET 9 page (figure 3-181). Press the left  to activate the left cursor and use the left inner and outer knobs to select a desired volume between 00 and 99. Increasing numbers increases the volume.

NOTE: The altitude alerting and height above airport features can be disabled in the KLN 90B installation harness so that these features are not selectable by the pilot. When this has been done the SET 5, SET 9, and Altitude pages display **OFF** and cannot be changed. In addition, the SET 5 and SET 9 pages display the following : **FEATURE DISABLED**.

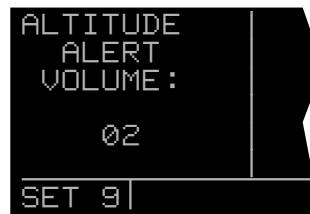

Figure 3-181

3.16 HEIGHT ABOVE AIRPORT ALERT

The height above airport alert feature can provide you a means of knowing when you are at traffic pattern altitude or when you are at a fixed height above the airport where you might perform any repetitive duty.

The height above airport feature works as follows: You enable/disable this feature and select an offset height on the SET 5 page (figure 3-182). When the height above airport alert is enabled, the KLN 90B creates a 5 nm radius cylinder of airspace centered on an airport. This airport is any airport that is a Direct To waypoint or is the "TO" waypoint in the active flight plan. The height of the cylinder above the airport is the offset height you select on the SET 5 page. The KLN 90B adds this offset height to the elevation stored in the database for the airport. The KLN 90B compares the aircraft's position relative to the cylinder and notifies you with an aural alert when the aircraft first penetrates the cylinder (figure 3-183). The alert consists of a short tone, followed by a long tone, followed by a short tone.



Figure 3-182

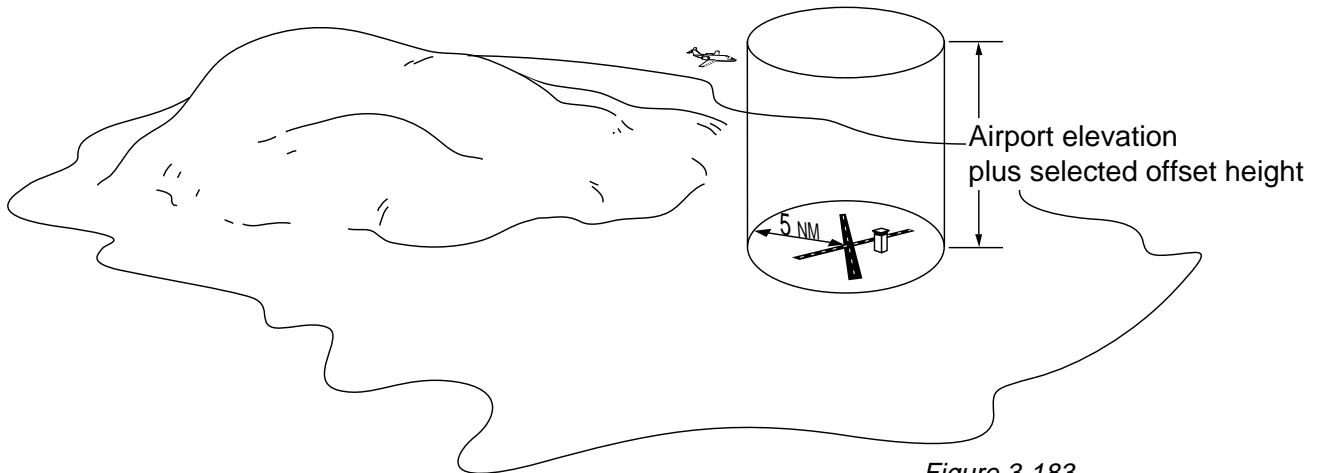

Figure 3-183

To enable or disable the height above airport alert, press the left **■**. Use the left outer knob to position the cursor over the enable/disable field. Turn the left inner knob to select **ON** or **OFF** as desired. To select the offset height, use the left outer knob to position the cursor over the offset field (figure 3-184). Turn the left inner knob to select an offset between 800 feet and 2000 feet. Press the left **■** to turn the cursor off.



Figure 3-184

WARNING: The height above airport alert feature does not serve the same function as a radar altimeter. It does not provide any warning about the aircraft's actual height above the airport's surrounding terrain.

The alert tone is provided in the same way as described in section 3.15, "Altitude Alerting". The volume is adjustable on the SET 9 page.

In order to use the height above airport alert, an altitude input must be provided to the KLN 90B. If the altitude input to the KLN 90B is pressure altitude such as from an altitude encoder or air data computer, then the altitude must be corrected with the proper altimeter baro setting. This is accomplished on the ALT page as described in section 3.15, "Altitude Alerting."

CAUTION: The height above airport alert feature will only be accurate if the altimeter baro correction is correct. If the height above airport alert feature is enabled, it is a good idea to update the altimeter baro set on the ALT page each time you make a change to the aircraft's altimeter setting.

NOTE: *The altitude alerting and height above airport features can be disabled in the KLN 90B installation harness so that these features are not selectable by the pilot. When this has been done the SET 5, SET 9, and Altitude pages display OFF and cannot be changed. In addition, the SET 5 and SET 9 pages display the following : FEATURE DISABLED.*

3.17 REMOTE MOUNTED ANNUNCIATORS

The KLN 90B has outputs capable of driving two remote annunciator lights: waypoint alert and message. Although these annunciators are optional, it is desirable to have them mounted in the pilot's normal scan area so that these annunciators are easily seen. A typical annunciator is shown in figure 3-185; however, actual annunciation abbreviations and configurations may be different.



Figure 3-185

In addition, there may be a NAV/GPS switch/annunciator to switch a CDI or HSI navigation source between the KLN 90B and a VOR/ILS system; a GPS APR switch/annunciator which allows display and control of the approach modes (see section 6.1; and a GPS CRS switch/annunciator which allows changing between Leg and OBS modes (see section 5.9.1).

The remote waypoint alert annunciator is on whenever waypoint alerting is occurring. See sections 3.8.6 and 4.2.2.

The remote message annunciator is on whenever the message prompt is on. See section 3.5.

3.18 SAMPLE TRIP

Just to make sure you are ready to use the KLN 90B for navigation, let's go through a sample trip to illustrate many of the features you have learned to use in this section of the Pilot's Guide. Our trip will be from Adams field (KLIT) in Little Rock, Arkansas to Mueller Municipal airport (KAUS) in Austin, Texas. The weather is perfect and you decide to make the trip VFR and fly direct to Austin.

3.18.1 Pre-Departure

1. Apply power to the KLN 90B by pushing the power/brightness knob to the "in" position.
2. When the screen warms up, adjust the brightness to the desired level by rotating the power/brightness knob.
3. Verify that the information on the Self Test page is correct, including the time and date. Enter the altimeter baro setting. Position the cursor over **APPROVE?** and press **■** to approve the Self Test page.
4. Read the Database page. Acknowledge the Database page by pressing **■**.
5. A blank NAV 2 page is now displayed on the left side on the screen. The APT 4 page for Adams field (**KLIT**), which shows the communications frequencies, is now displayed on the right side of the screen since **KLIT** was the active waypoint when you last removed power from the KLN 90B. The APT 4 page indicates that the ATIS frequency is 125.65 MHz, the pre-taxi clearance delivery frequency is 118.95 MHz, the ground control frequency is 121.90 MHz, and the tower frequency is 118.70 MHz. After listening to ATIS, you contact clearance delivery for your clearance out of the Little Rock Class C airspace. Next, you give ground control a call and receive your taxi clearance.
6. By this time the KLN 90B has reached a NAV ready status. You know this because the NAV 2 page is now showing a valid present position, in this case 3.8 nautical miles on the 320 degree radial from Little Rock (**LIT**) VOR.
7. Press **■** to bring up the Direct To page on the left side. Use the two left knobs to enter the identifier of Mueller Municipal airport (**KAUS**) by using the left inner knob to select the characters and the left outer knob to move the flashing part of the cursor to the desired cursor location.
8. Press **■** to bring up the APT 1 waypoint page for Mueller Municipal airport on the right side.

9. Press **■** again to approve the waypoint page. The NAV 1 page is now displayed on the right side of the screen while the NAV 2 page returns to the left side. The NAV 1 page indicates it is 384 nautical miles to Austin and that the bearing is 225 degrees. After take-off, the NAV 1 page will also display ground-speed and estimated time enroute.
10. You now decide to view the Super NAV 1 page. Rotate the left inner knob to select the NAV 1 page.

3.18.2 Enroute

1. You depart from runway 36 at Little Rock and are told to "maintain runway heading". After several radar vectors for traffic avoidance you are finally cleared on course. The D-Bar indicates that the radar vectors have taken you north of the original course and you decide to proceed Direct To Austin from your present position. To recenter the D-Bar, press **■**, and then press **■**.
2. In order to determine the minimum enroute safe altitude (ESA) for the flight you view the NAV 3 page. It indicates an ESA of 4300 feet for the trip and minimum safe altitude for your present position of 3400 feet.
3. After departure control has directed "squawk 1200, frequency change approved", you decide it would be a good idea to obtain VFR flight following. To obtain the frequency for Center, select the Other 2 page (**OTH 2**). It indicates that for your position, you should be able to contact Memphis Center on 118.85 MHz.
4. You've only flown about 100 nautical miles, but you begin wondering where you would go if an engine suddenly started running rough. You decide to use the KLN 90B to determine where the nearest airports are from your present location. To view the nearest airports press **■**, and then press **■**. The nearest airport is Hope Municipal (**M18**) which is eight nautical miles from your position on a bearing to the airport of 11 degrees. You now rotate the right inner knob to view the other APT pages for Hope Municipal. You learn, for example, that it is located in Hope, Arkansas, and has two hard surface runways that are each 5500 feet in length. By pulling the right inner knob to the "out" position, you may now scan clockwise through the remaining eight airports in the nearest airport list.
5. For the majority of the enroute portion of the flight you select, the Super NAV 5 page's moving map display. You do this by selecting NAV 5 on both sides of the screen. Pressing the right **■** brings up the waypoint display menu on the right side of the screen. You then use the right knobs to select **APT: ON** so that nearby airports are shown on the moving map display.

While the display menu is displayed, select the track up map orientation (TK) as well. Pressing the right **■** again removes the menu from the screen. You select the 30 nm range scale on the left side using the left **■** and left knobs. You also decide to display ETE, DTK, and TK on the left side of the map display by using the left knobs.

6. Since it is a good idea to not rely on just one navigation source, you decide to cross check the KLN 90B position against other equipment in the aircraft. The NAV 2 page indicates you are presently located on the Texarkana (**TXK**) VOR 68 degree radial at a distance of 19 nautical miles. By tuning your Navigation Receiver and DME to **TXK**, you are able to confirm that this is the correct position.

3.18.3 Terminal Area

1. About 50 nautical miles from Austin's Mueller airport you start preparing for your arrival. Viewing the APT 4 page for **KAUS** you determine that the ATIS frequency is 119.20 MHz and tower is 121.00 MHz.
2. A few minutes later, the message prompt begins flashing. When you press **■**, the message page advises: **AIRSPACE ALERT - AUSTIN CL C - SEE KAUS APT 4 PAGE BELOW 4600 FT**. The Special Use Airspace Alert feature has determined that you are within 10 minutes of penetrating the Austin Class C airspace. When you view the APT 4 page, you see that the Class C airspace frequencies are sectorized. You determine from the APT 4 page that the proper frequency to use is 124.90 MHz since you are Northeast of Austin and 124.90 MHz is the appropriate frequency to use from 3 degrees to 170 degrees.
3. After you call Austin approach control for clearance into the Class C airspace, you view the rest of the APT pages for KAUS to determine the field elevation and available runways. The first APT 3 page shows you a runway diagram for the airport.
4. After landing, the KLN 90B is turned off either by pulling the power/brightness switch to the "out" position or with the avionics master switch if one is installed.

THIS PAGE INTENTIONALLY LEFT BLANK

CHAPTER 4 - LEVEL 2 OPERATION

This is the second of four chapters specifically dealing with operating the KLN 90B. In this chapter you will learn to create and use flight plans. A flight plan is an organized listing of waypoints defining your route of flight.

You may feel that you learned all you need to know in chapter 3 about operating the KLN 90B, since you can use the Direct To operation to fly anywhere you want to go. However, you would be selling yourself and the KLN 90B short if you stop there. Using the unit's flight plan capabilities provides more information and, in some respects,

reduces your enroute workload regardless of whether your flying is done VFR or IFR. Other advantages of creating flight plans are: (1) the entire route of flight for an upcoming trip can be created and stored prior to departure; and (2) the routes for frequently made trips need to be created just once and may then be recalled as required for later use. Using the KLN 90B only for Direct To operation would be like flying a retractable gear aircraft with the gear down all the time — you're just not getting the most out of your equipment!

4.1 CREATING AND MODIFYING FLIGHT PLANS

The following rules and considerations apply to KLN 90B flight plans:



- The KLN 90B is capable of storing in its memory 25 flight plans plus an active flight plan.
- Each of the flight plans may contain up to 30 waypoints. These waypoints may consist of any combination of published waypoints from the database or user created waypoints.
- The flight plans are numbered 0 through 25 (FPL 0, FPL 1, FPL 2, ..., FPL 25).
- The active flight plan is always FPL 0. The standard procedure is to create a flight plan in one of the flight plans numbered as FPL 1, FPL 2, FPL 3, ..., or FPL 25. When one of these numbered flight plans is activated, it becomes FPL 0, the active flight plan. This Pilot's Guide will refer to FPL 0 as the "active flight plan" and FPL 1 through FPL 25 as the "numbered flight plans." If desired, a flight plan can be created directly in the active flight plan. This avoids creating the flight plan in a numbered flight plan and then having to activate it. The disadvantage is that if a numbered flight plan is subsequently made active, the one programmed directly into FPL 0 will be lost.
- Modifications may be made to FPL 0 without affecting the way it is stored as a numbered flight plan.
- Unless Direct To operation is being used, the active flight plan (FPL 0) must contain at least two waypoints. Otherwise, the KLN 90B system will be flagged.

4.1.1 Creating A Flight Plan

A flight plan for a flight from Lakefront airport in New Orleans, LA. to St. Petersburg/Clearwater, FL. International airport will be used as an example of how to create a flight plan. The waypoints making up the flight plan are: **KNEW** (Lakefront airport), **GPT** (Gulfport VOR), **SJI** (Semmes VOR), **CEW** (Crestview VOR), **MAI** (Marianna VOR), **TLH** (Tallahassee VOR), **CTY** (Cross City VOR), and **KPIE** (St. Petersburg/Clearwater International airport). To create the flight plan:

1. Rotate the left outer knob to select the flight plan (FPL) type pages (figure 4-1).
2. Turn the left inner knob to select a flight plan page (preferably other than FPL 0) which does not contain a flight plan (figure 4-2). If all of the flight plan pages contain flight plans, refer to section 4.1.5, "Deleting Flight Plans."
3. Press the left  to turn on the cursor function for the left page (figure 4-3).

NOTE: The KLN 90B flight plan operation is designed so that the first waypoint in the flight plan should always be the departure point. Remember to enter the "K", "P", or "C" prefix for certain airports in the United States, Alaska, or Canada. See section 2.3, "USE OF ICAO IDENTIFIERS."

4. Use the left inner knob to select the first character of the departure waypoint identifier (figure 4-4).
5. Turn the left outer knob one step clockwise to move the flashing portion of the cursor over the second character position, and then use the left inner knob to select the desired character.
6. Use the above procedure to select the entire identifier for the first waypoint (figure 4-5).
7. Press . A waypoint page for the identifier just entered will be displayed on the right side (figure 4-6). If a mistake was made and the wrong waypoint identifier was entered, press  and begin again. If a mistake was not made but the waypoint identifier just entered isn't in the database, a page allowing creation of a user defined waypoint will appear on the right side. Refer to section 5.4, "USER-DEFINED WAYPOINTS", for instruction on how to define a user created waypoint.
8. Press  again to approve the waypoint page being displayed. The cursor will move to the second waypoint position (figure 4-7).

NOTE: A small number of waypoints are stored in the database as "fly-over" waypoints. These waypoints are associated with SID/STAR procedures. "Fly-over" means

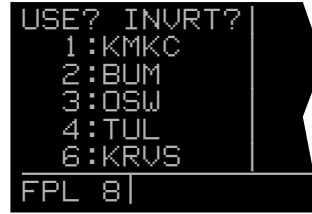

Figure 4-1

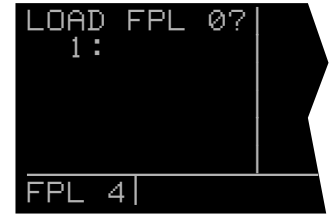

Figure 4-2



Figure 4-3



Figure 4-4

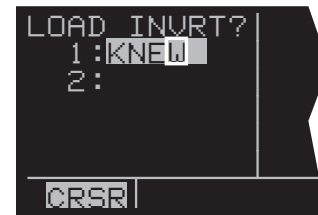

Figure 4-5

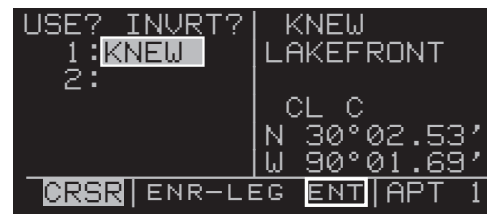

Figure 4-6

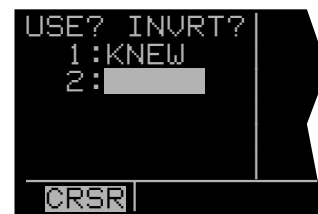

Figure 4-7

that, for some reason, the governing agencies have decided that it is important to fly directly over the waypoint instead of being able to “cut the corner” by using turn anticipation (see section 4.2.2). In these cases the KLN 90B will present a waypoint type identification page (Figure 4-7a). Simply select the way in which the waypoint is intended to be used with the left outer knob and press **ENT**. If the SID/STAR choice is selected, the KLN 90B will disable turn anticipation for that waypoint (if previously enabled). The KLN 90B will enable turn anticipation after the waypoint has been passed (if turn anticipation was previously enabled). If en route is selected, then normal turn anticipation occurs.

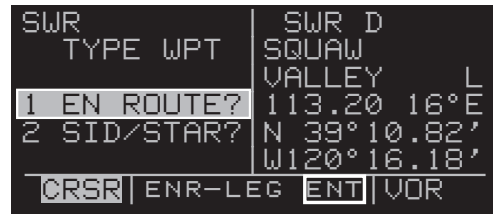

Figure 4-7a

9. Use the same procedure to enter the rest of the waypoints in the flight plan (figure 4-8). If the flight plan consists of five or more waypoints, the waypoints will automatically scroll as necessary to allow entry of the next waypoint.



Figure 4-8

10. When all of the waypoints have been entered in the flight plan, the left outer knob may be rotated to move the cursor up and down and manually “scroll” through the waypoints making up this flight plan. This is useful if the flight plan contains six or more waypoints since not all of the waypoints can be displayed at one time. When the left outer knob is rotated to the full counterclockwise position, the cursor will be positioned over **USE?** (figure 4-9). If there are more than five waypoints in the flight plan, the first four waypoints will then be displayed followed by the last waypoint in the flight plan. Rotate the left outer knob to move the cursor and manually scroll to see the missing intermediate waypoints.

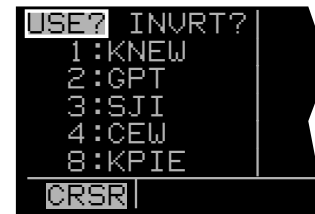

Figure 4-9

11. Press the left **ENT** to turn off the left cursor function. Additional flight plans may now be created in the same manner.

4.1.2 Activating A Numbered Flight Plan

To activate one of the previously created numbered flight plans:

1. Use the left outer knob to select the flight plan (FPL) type pages.
2. Rotate the left inner knob to select the desired flight plan (figure 4-10).
3. Press the left **ENT** to enable the left cursor function. The cursor will appear over **USE?** (figure 4-11). If you haven't left the numbered flight plan page since creating this flight plan, rotate the left outer knob all the way counterclockwise to position the cursor over **USE?**

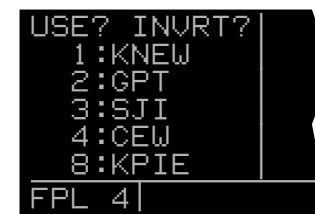

Figure 4-10

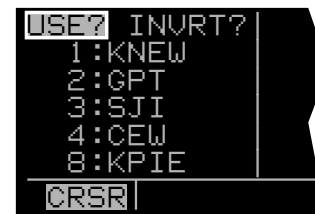

Figure 4-11

- Press **■** to activate the flight plan in the order shown (figure 4-12). To activate the flight plan in inverse order (first waypoint becomes last and last waypoint becomes first), rotate the left outer knob one step clockwise to position the cursor over **USE? INVRT?** before pressing **■** (figure 4-13).
- The selected flight plan is now displayed as FPL 0, the active flight plan. Any changes made to FPL 0 will not affect how this flight plan is stored as the numbered flight plan.

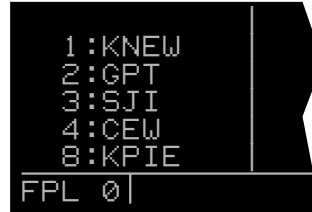

Figure 4-12

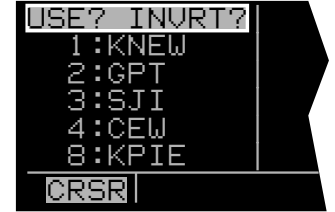

Figure 4-13

4.1.3 Adding A Waypoint To A Flight Plan

A waypoint may be added to any flight plan containing fewer than 30 waypoints. To add a waypoint to a flight plan:

- Press the left **■** to enable the left cursor function if it is not on already (figure 4-14).
- Rotate the left outer knob as necessary to position the cursor over the waypoint identifier which you desire to follow the waypoint being added. Another way to think of this is to position the cursor over the location in the flight plan you wish the new waypoint to be added. For example, if **SJI** is presently the third waypoint in the flight plan and you wish to insert **BUGLE** intersection in the number three position in front of **SJI**, move the cursor over **SJI** (figure 4-15).
- Use the left inner knob to enter the first character of the waypoint being inserted. As you begin to turn the knob, the existing waypoint in this position automatically jumps down to the next position. In this case, **SJI** automatically moves to waypoint four (figure 4-16).
- Use the left outer and inner knobs in the normal manner to complete entering the waypoint identifier (figure 4-17).
- Press **■** to display the waypoint page on the right side for the identifier just entered.
- Press **■** again to approve the waypoint page (figure 4-18).
- Press the left **■** to turn off the left cursor function.

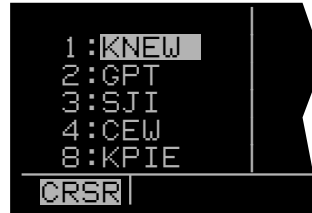

Figure 4-14



Figure 4-15



Figure 4-16

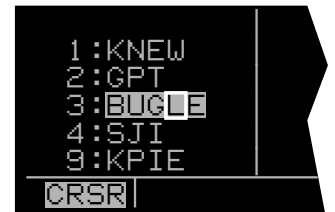

Figure 4-17

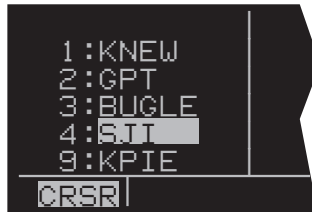

Figure 4-18

4.1.4 Deleting A Waypoint From A Flight Plan

To delete a waypoint from a flight plan:

1. Press the left **█** to enable the left cursor function if it is not on already.
2. Rotate the left outer knob as necessary to position the cursor over the waypoint to be deleted (figure 4-19).
3. Press **█**. The letters **DEL** (delete) will appear to the left of the identifier and a question mark will appear to the right of the identifier (figure 4-20). If a mistake was made and you do not wish to delete this waypoint, press **█**.
4. Press **█** and the waypoint will be deleted from the flight plan. The other waypoints in the flight plan will be correctly repositioned (figure 4-21).
5. Press the left **█** to turn off the left cursor function.



Figure 4-19

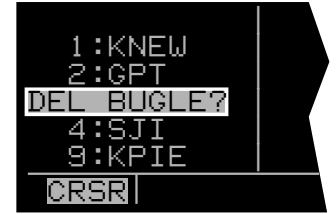

Figure 4-20



Figure 4-21

4.1.5 Deleting Flight Plans

To delete a flight plan which is no longer required:

1. Display the flight plan (FPL 0, FPL 1, FPL 2,..., or FPL 25) which is to be cleared (figure 4-22).
2. Make sure the left cursor function is turned off. If the left cursor is on, press the left **█** to turn it off.
3. Press **█**. The words **DELETE FPL?** will appear at the top of the page (figure 4-23). If a mistake was made and you do not wish to clear this flight plan, press **█**.
4. Press **█** to clear the flight plan (figure 4-24).



Figure 4-22



Figure 4-23

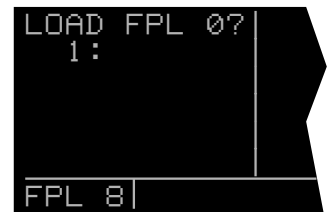

Figure 4-24

4.1.6 Storing FPL 0 As A Numbered Flight Plan

The active flight plan may be loaded into a numbered flight plan so that it can be recalled for later use. This may be desirable, for example, if the active flight plan was originally created on the FPL 0 page and not as a numbered flight plan. To store the active flight plan as a numbered flight plan:

1. Select a numbered flight plan page which does not contain any waypoints (figure 4-25). If none exist, use the procedure described in n 4.1.5, "Deleting Flight Plans," to clear a flight plan which is no longer required.
2. Press the left **█** to turn on the left cursor function with the cursor over the blank first waypoint position (figure 4-26).
3. Rotate the left outer knob one step counterclockwise to position the cursor over **LOAD FPL 0?** (figure 4-27).
4. Press **█** to load the active flight plan into this numbered flight plan (figure 4-28).

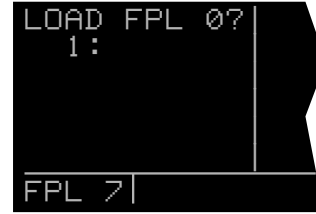

Figure 4-25



Figure 4-26



Figure 4-27

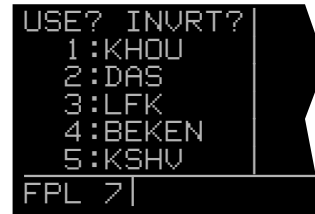

Figure 4-28

4.2 OPERATING FROM THE ACTIVE FLIGHT PLAN

4.2.1 General Procedures

Everything you have learned in this Pilot's Guide thus far is applicable to using the KLN 90B for flight plan operation. The following rules and considerations apply for flight plan operation while the KLN 90B is in the Leg mode:

- Although any of the KLN 90B pages may be utilized while operating along a flight plan, common page selections are the FPL 0 page on the left side while simultaneously displaying one of three Distance/Time pages (D/T 1, D/T 2, D/T 3) or the NAV 5 page (navigation graphics) on the right side. The information contained on the Distance/Time pages is explained later, beginning in section 4.2.5, "The Distance/Time Pages". The Super NAV 5 page is especially useful for flight plan operation. It provides you with a visual orientation of your position in the active flight plan and displays the alphanumeric identifiers of the flight plan waypoints. Of course the other four Navigation pages may also be used extensively. Now would be a good time to take a couple of minutes and review the NAV 5 and Super NAV 5 pages as they relate to flight plan operation (see sections 3.9.6 and 3.9.7).



Figure 4-29

- Always verify that you are viewing the active flight plan page (FPL 0) and not one of the other numbered flight plan pages.



Figure 4-30

- The active leg of the flight plan is designated with a \leftarrow symbol. A leg is defined as the course line between a pair of waypoints (a "from" waypoint and a "to" waypoint). The head of the arrow is positioned to the left of and points to the active "to" waypoint. In figure 4-29, **GPT** is the "to" waypoint. The tail of the \leftarrow symbol is positioned to the left of the "from" waypoint. **KNEW** is the "from" waypoint in figure 4-29. The \leftarrow symbol is not displayed unless the KLN 90B is actually receiving navigation signals suitable for navigation. (Note: If the unit is in the take-home mode, it has been "tricked" into thinking it is receiving signals and therefore the \leftarrow symbol can be displayed). Also, the \leftarrow symbol will not be displayed if Direct To navigation is occurring. If in doubt as to whether or not Direct To operation is occurring, view the NAV 1 page. If the top line shows the \oplus symbol (figure 4-30) instead of a "from" waypoint (figure 4-31), then Direct To navigation is occurring. If it is desired to cancel the Direct To operation and operate from the active flight plan; press \blacksquare , then press \blacksquare , then press \blacksquare .

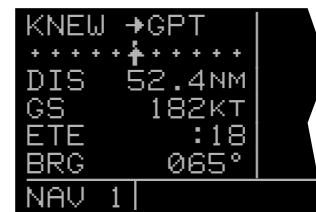

Figure 4-31

- As flight plan waypoints are reached, the active leg symbol automatically orients itself on the next leg.

- If the flight plan contains more waypoints than can be displayed on the screen at one time, the page will automatically scroll as progress is made along the flight plan so that the active leg is always displayed (figure 4-32).
- The last waypoint in the flight plan is always displayed at the bottom of the FPL 0 page, even if all of the waypoints in the flight plan can't be displayed on the page at one time. To view intermediate waypoints, turn the left cursor function on and use the left outer knob to manually scroll through all of the waypoints, as desired. If scrolling is performed all the way to the end of the flight plan, a blank waypoint position will exist so that a waypoint may be added to the end of the flight plan (figure 4-33).

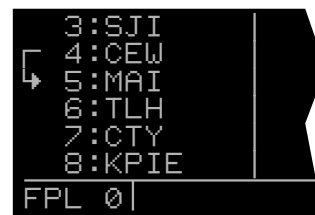

Figure 4-32



Figure 4-33

4.2.2 Turn Anticipation And Waypoint Alerting

Prior to reaching a waypoint in the active flight plan, the KLN 90B will provide navigation along a curved path segment to ensure a smooth transition between two adjacent legs in the flight plan. That is, the CDI or HSI left/right deviation will be referenced to the dashed line in figure 4-34. This feature is called turn anticipation. The transition course is based upon the aircraft's actual groundspeed and the amount of course angle change between the two legs. The KLN 90B automatically sequences to the next leg after passing the midpoint in the transition segment.

Approximately 20 seconds prior to the beginning of turn anticipation, the arrow preceding the active waypoint identifier will begin flashing on the FPL 0 page and on any Navigation page, Distance/Time page, or waypoint page displaying the active waypoint identifier (figure 4-35). On the Super NAV 5 page, the entire active waypoint identifier will start to flash. This is called "waypoint alerting". If an external waypoint alert annunciator is mounted in the aircraft, this annunciator will begin flashing at the same time.

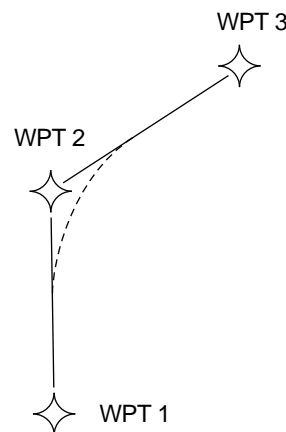

Figure 4-34

To utilize the turn anticipation feature, start the turn transitioning to the next leg in the flight plan at the very beginning of turn anticipation. This occurs when the external waypoint alert annunciator or the active waypoint identifier on the Super NAV 5 page stops flashing and goes on steady. At this time the KLN 90B will notify you with a message on the Message page of the new desired track to select on your HSI or CDI.

ADJ NAV IND CRS TO 123°

A message will not be given if the change in desired track (course change) is less than 5°. In addition, a message will not be given if the KLN 90B is interfaced with an EHSI or HSI having a course pointer that is automatically slewed to the correct desired track.



Figure 4-35

The desired track (**DTK**) displayed on the NAV 3 page also changes to the value for the next leg at the beginning of turn anticipation. Turn anticipation becomes inactive when transition to the next leg has been made.

In some installations the KLN 90B can “read” the selected course set on external CDIs or HSIs. In these installations the KLN 90B will flash the value of desired track (DTK) on both the NAV 3 and Super NAV 5 pages when the desired track and the selected course differ by more than 10°. Set the selected course to match the desired track. This will make sure that the orientation “picture” is always correct.

If desired, turn anticipation may be disabled (or enabled) on the Setup 6 page (**SET 6**) using the left  and the left inner knob to select between **DISABLE** or **ENABLE** (figure 4-36). If turn anticipation is disabled, navigation is provided all the way to the waypoint, and waypoint alerting occurs approximately 36 seconds prior to actually reaching the waypoint.



Figure 4-36

4.2.3 Viewing The Waypoint Pages For The Active Flight Plan Waypoints

The waypoint pages(s) for each of the waypoints in the active flight plan may be easily displayed by selecting the Active Waypoint page type (ACT) on the right side. When the ACT page type is first selected, the waypoint page for the active waypoint will be displayed (figure 4-37). The location of the waypoint in the flight plan (waypoint 1, waypoint 2, etc.) is annunciated with a number to the left of the identifier. In addition, an arrow to the left of the waypoint number designates the active waypoint. The letter to the far right of the identifier designates the type of waypoint: **A** = airport, **V** = VOR, **N** = NDB, **I** = intersection, **S** = supplemental or **T** = terminal (for details on terminal waypoints see section 6.1.2). For VORs having DME capability, the letter D is displayed between the VOR identifier and the V. To view the other waypoints in the flight plan, pull the right inner knob to the "out" position and turn it to view each of the waypoints in the order they are contained in the flight plan (figure 4-38). For airport waypoints, the right inner knob may be pushed back to the "in" position and rotated to display any of the eight airport pages (figure 4-39). Pulling the knob back out will allow further scanning of the waypoint pages in the active flight plan.

1:KNEW	→ 2 GPT D V
2:GPT	GULFPORT
3:SJI	L
4:CEW	109.00 2°E
5:MAI	N 30°24.40'
8:KPIE	W 89°04.60'
FPL 0 ENR-LEG ACT	

Figure 4-37

1:KNEW	8 KPIE A
2:GPT	ST PETES-
3:SJI	CLERWTR
4:CEW	CL B
5:MAI	N 27°54.63'
8:KPIE	W 82°41.26'
FPL 0 ENR-LEG ACT 1	

Figure 4-38

4.2.4 Combining Direct To And Flight Plan Operation

It is very common when using flight plan operation to use the Direct To function to proceed directly to a waypoint which exists in the flight plan. For example, after takeoff it is common to receive radar vectors in the terminal area and then be given a clearance direct to the first point in the flight plan that was filed. The KLN 90B makes this kind of operation very easy to accomplish. Whenever you do a Direct To operation to a waypoint which is in the active flight Plan (FPL 0), the system will provide navigation to the waypoint and then automatically resume navigation along the flight plan when the Direct To waypoint is reached. Waypoints which exist prior to the Direct To waypoint in the active flight plan are bypassed. Of course, the active flight plan will never be resumed if the Direct To operation is to a waypoint which is not in the active flight plan.

1:KNEW	8 KPIE A
2:GPT	
3:SJI	17L/35R L
4:CEW	8500' HRD
5:MAI	04 /22 L
8:KPIE	5500' HRD
FPL 0 ENR-LEG ACT+3	

Figure 4-39

Any of the several methods previously described for initiating Direct To operation may be used, although the one below is the easiest for this application. The procedure below takes advantage of rule number 1 described in section 3.8.

1. Select the FPL 0 page of the left side.
2. Press the left **▀** and then use the left outer knob to position the cursor over the desired waypoint (figure 4-40).
3. Press **▀**. The waypoint page for the selected waypoint in FPL 0 will be displayed on the right side (figure 4-41).
4. Press **▀** to approve the waypoint page. The Direct To waypoint identifier in the active flight plan will now be preceded by just an arrow (figure 4-42). The **↵** symbol is not displayed since there is no “from” waypoint in the flight plan.

1:KNEW	→ 2 GPT D U
2:GPT	GULFPORT
3:SJI	
4:CEW	109.00 2°E
5:MAI	N 30°24.40'
8:KPIE	W 89°04.60'
CRSR	ENR-LEG ACT

Figure 4-40

DIRECT TO:	SJI D
	SEMMES
SJI	
	115.30 5°E
	N 30°43.55'
	W 88°21.56'
CRSR	ENR-LEG ENT VOR

Figure 4-41

1:KNEW	B→SJI
2:GPT	*****↑*****
→ 3:SJI	DIS 90.4NM
4:CEW	GS 180KT
5:MAI	ETE :30
8:KPIE	BRG 062°
FPL 0	ENR-LEG NAV 1

Figure 4-42

An alternative method is to use the Super NAV 5 page to select the direct to waypoint. This is done by pulling out on the right inner knob. With the inner knob out, it is possible to scan through the waypoints of the active flight plan as described in section 3.9.7. When the desired waypoint is highlighted, press **▀** and then **▀**.

If for some reason it is desired to cancel the Direct To operation prior to reaching the Direct To waypoint in order to proceed along the flight plan leg, press **▀**, then press **▀**, and then press **▀**.

4.2.5 The Distance/Time Pages

As stated earlier, it is common to use the Distance/Time pages in conjunction with flight plan operation. The Distance/Time pages are specially designed to be most useful when the active flight plan page (FPL 0) is displayed simultaneously on the left side.

4.2.6 The Distance/Time 1 Page (D/T 1)

When the FPL 0 page is displayed on the left side and the D/T 1 page is displayed on the right side, the distance (DIS) and estimated time enroute (ETE) are displayed for each of the active flight plan waypoints (figure 4-43). The distance displayed is the cumulative distance from the aircraft's present position to each waypoint along the flight plan route. The ETE is displayed in hours:minutes. If Direct To operation is occurring to a waypoint that is not in the active flight plan, then the D/T 1 page is blank when the FPL 0 page is displayed on the left (figure 4-44).

1:KNEW	DIS	ETE
2:GPT	34	:11
3:SJI	76	:25
4:CEW	163	:54
5:MAI	243	1:21
8:KPIE	477	2:39
FPL 0	ENR-LEG	D/T 1

Figure 4-43

1:KNEW	DIS	ETE
2:GPT		
3:SJI		
4:CEW		
8:KPIE		
FPL 0	ENR-LEG	D/T 1

Figure 4-44

If a numbered flight plan page (FPL 1 though FPL 25) is displayed on the left side, the distances displayed are from the first waypoint in the flight plan and have nothing to do with the aircraft's present position. No ETEs are then shown (figure 4-45).

USE? INVRT?	DIS	ETE
1:KMKC		
2:BUM	51	
3:OSW	126	
4:TUL	190	
7:KDAL	432	
FPL 6	ENR-LEG	D/T 1

Figure 4-45

If a non-flight plan page is displayed on the left, the format of the D/T 1 page changes to display just the distance and ETE for the active waypoint and for the last waypoint in the flight plan (figure 4-46).

4.2.7 The Distance/Time 2 Page (D/T 2)

When the FPL 0 page is displayed on the left side and the D/T 2 page is displayed on the right side, the distance and estimated time of arrival are displayed for each of the active flight plan waypoints (figure 4-47). The distances are as described for the D/T 1 page. The time zone associated with the estimated time of arrival is announced at the top right of the D/T 2 page. The time zone may be changed by enabling the right cursor function to bring the cursor over the time zone, and then turning the right inner knob to select the desired time zone (figure 4-48). Changing the time zone on the D/T 2 page changes the time zone on other pages where time is displayed.

If a numbered flight plan page other than FPL 0 is displayed on the left side, no estimated times of arrival are displayed (figure 4-49).

If a non-flight plan page is displayed on the left side, the format of the D/T 2 page changes to display just the distance and estimated time of arrival for the active waypoint and for the last waypoint in the flight plan (figure 4-50).

4.2.8 The Distance/Time 3 Page (D/T 3)

When any flight plan page is displayed on the left side and the D/T 3 page is displayed on the right side, the distance and desired track (DTK) are displayed (figure 4-51). The distances are as described for the D/T 1 page. The desired track is the great circle course between two waypoints. You should view the diagram in Appendix A if you are unfamiliar with this term.

If a non-flight plan page is displayed on the left side, the format of the D/T 3 page changes to display just the distance and desired track for the active waypoint and for the next waypoint in the flight plan (figure 4-52). Note that this is different than for the D/T 1 and D/T 2 pages.

KNEW →GPT	→ 2 GPT
*****↑*****	DIS 34NM
DIS 34.2NM	ETE :11
GS 180KT	8 KPIE
ETE :11	DIS 477NM
BRG 064°	ETE 2:39
NAV 1 ENR-LEG	D/T 1

Figure 4-46

1:KNEW	DIS	CST
2:GPT	34	09:23
3:SJI	76	09:37
4:CEW	163	10:06
5:MAI	243	10:33
8:KPIE	477	11:51
FPL 0 ENR-LEG	D/T 2	

Figure 4-47

1:KNEW	DIS	UTC
2:GPT	34	15:23
3:SJI	76	15:37
4:CEW	163	16:06
5:MAI	243	16:33
8:KPIE	477	17:51
FPL 0 ENR-LEG	CRSR	

Figure 4-48

USE? INVRT?	DIS	CST
1:KMKC		
2:BUM	51	
3:OSW	126	
4:TUL	190	
7:KDAL	432	
FPL 7 ENR-LEG	D/T 2	

Figure 4-49

KNEW →GPT	→ 2 GPT
*****↑*****	DIS 34NM
DIS 34.2NM	15:23UTC
GS 180KT	8 KPIE
ETE :11	DIS 477NM
BRG 064°	17:51UTC
NAV 1 ENR-LEG	D/T 2

Figure 4-50

1:KNEW	DIS	DTK
2:GPT	34	063°
3:SJI	76	061°
4:CEW	163	085°
5:MAI	243	092°
8:KPIE	477	172°
FPL 0 ENR-LEG	D/T 3	

Figure 4-51

KNEW →GPT	→ 2 GPT
*****↑*****	DIS 34NM
DIS 34.2NM	DTK 064°
GS 180KT	3 SJI
ETE :11	DIS 76NM
BRG 064°	DTK 061°
NAV 1 ENR-LEG	D/T 3

Figure 4-52

4.2.9 The Distance/Time 4 Page (D/T 4)

The format of the D/T 4 page does not change. It displays on a single page the pertinent times for the flight regardless of what is displayed on the left page and regardless of whether flight plan or Direct To operation is occurring (figure 4-53). The information displayed on the D/T 4 page is the following:

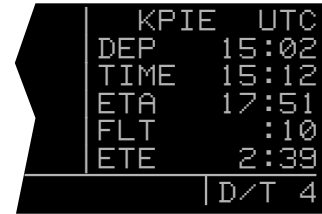

KPIE	UTC
DEP	15:02
TIME	15:12
ETA	17:51
FLT	:10
ETE	2:39
D/T 4	

Figure 4-53



FLIGHT TIMER OPERATION
RUN WHEN GS > 30KT
SET 4

Figure 4-54

- The destination waypoint.
- The selected time zone. The time zone may be changed by pressing the right **■** and using the right inner knob to select the desired time zone.
- **DEP** - The departure time. There are two definitions of departure time depending on what has been selected on the Setup 4 page (**SET 4** - see figure 4-54). If the SET 4 page displays **RUN WHEN GS > 30KT**, then the departure time is that time when the groundspeed first reached 30 knots. If instead, the SET 4 page displays **RUN WHEN POWER IS ON**, then the departure time is the time when power was applied to the KLN 90B. The SET 4 page may be changed by pressing the left **■** while the SET 4 page is displayed on the left side and then rotating the left inner knob. Press the left **■** again to turn the left cursor function off.
- **TIME** - The present time. The time may be reset on the Self Test page at system turn-on or on the SET 2 page.
- **ETA** - The estimated time of arrival at the destination waypoint.
- **FLT** - The flight time. If **RUN WHEN GS > 30 KT** is selected on the SET 4 page, then flight time is the amount of time that the aircraft's groundspeed has been above 30 knots. Normally, this will be the time since takeoff. However, time spent at groundspeeds less than 30 knots such as intermediate stops without shutting down power or helicopter hovering is not counted as flight time.

If the present position flags (NAV flag) after being valid in the NAV mode, the flight timer continues to run if the groundspeed was more than 30 knots immediately before the flag.

If **RUN WHEN POWER IS ON** is selected on the SET 4 page, then flight time is the time since power on.

- **ETE** - Estimated time enroute to the destination waypoint.

THIS PAGE INTENTIONALLY LEFT BLANK

4.3 SAMPLE TRIP

Let's use a sample trip to illustrate some of the KLN 90B's flight plan features you learned to use in this section of the Pilot's Guide. The flight will be from Lakefront airport in New Orleans, LA. (**KNEW**) to St. Petersburg/Clearwater, FL. international airport (**KPIE**). You decide to fly mostly an inland route rather than following the coast to avoid the many restricted areas and MOAs and also to avoid thunderstorms which are occurring off the coast around Panama City (figure 4-55). The pages viewed in this scenario assume that the KLN 90B is driving an external HSI or CDI. If your KLN 90B installation is not interfaced with an external HSI or CDI, then your page selection would have more emphasis on the NAV 1 and Super NAV 1 pages than presented here.

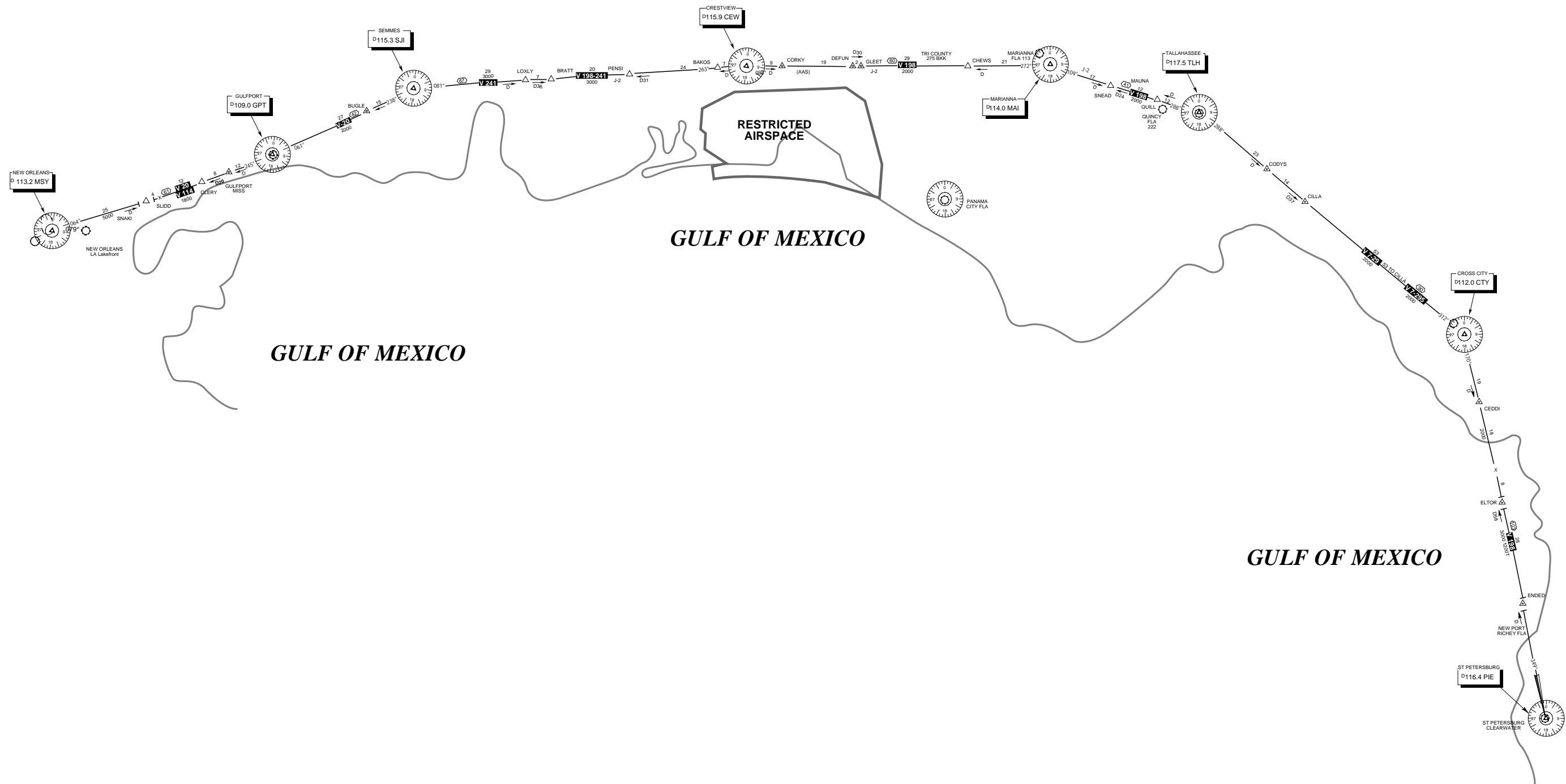

4.3.1 Pre-Departure

1. After turn-on and approval of the Self Test and Database pages, the APT 4 page (airport communication frequencies) for **KNEW** is displayed on the right side of the screen. Viewing the APT 4 page, you set up the COMMs for ATIS, Clearance Delivery, Ground, and Tower.
2. You create the flight plan on the FPL 4 page exactly as described for this route in section 4.1.1. The flight plan route is from **KNEW**, to **GPT** (Gulfport VOR), to **SJI** (Semmes VOR), to **CEW** (Crestview VOR), to **MAI** (Marianna VOR), to **TLH** (Tallahassee VOR), to **CTY** (Cross City VOR), to **KPIE**.
3. The flight plan is now activated (made FPL 0) as described in section 4.1.2.
4. Until the KLN 90B reaches a NAV ready status, there is no \curvearrowright symbol to indicate the active flight plan leg on the FPL 0 page and no distances displayed on the D/T 1 page (figure 4-56).
5. Shortly, the KLN 90B reaches a NAV ready status (figure 4-57). You see that the distance is 496 NM to St. Petersburg/Clearwater along the flight plan route. The active leg of the flight plan is **KNEW - GPT** and is so indicated on the FPL 0 page 2 with the \curvearrowright symbol.
6. You briefly view the D/T 3 page to determine that the desired track to the first waypoint, **GPT**, is 63 degrees (figure 4-58).

	DIS	ETE
1:KNEW		
2:GPT	----	--:--
3:SJI	----	--:--
4:CEW	----	--:--
8:KPIE	----	--:--
FPL 0	ENR-LEG	D/T 1

Figure 4-56

	DIS	ETE
\curvearrowright 1:KNEW		
2:GPT	54	--:--
3:SJI	95	--:--
4:CEW	182	--:--
5:MAI	263	--:--
8:KPIE	496	--:--
FPL 0	ENR-LEG	D/T 1

Figure 4-57

	DIS	DTK
\curvearrowright 1:KNEW		
2:GPT	54	063°
3:SJI	95	061°
4:CEW	182	085°
5:MAI	263	092°
8:KPIE	496	172°
FPL 0	ENR-LEG	D/T 3

Figure 4-58

4.3.2 Enroute

1. After departure from runway 18R at Lakefront airport, you receive radar vectors out of the New Orleans Class B airspace. Finally, you are cleared direct Gulfport. At this point you are slightly South of the original course because of the radar vectors. Since you are displaying the D/T 1 page (a non-waypoint page) on the right side, to proceed direct to the active waypoint in the flight plan you press \blacksquare , and then press \blacksquare (figure 4-59). Remember that if a waypoint page would have been displayed on the right side when \blacksquare was pressed, the Direct To page would have contained that waypoint's identifier, not the active waypoint's identifier). You reselect the D/T 1 page on the right side (figure 4-60). Since you are still climbing at 120 knots, the ETEs are not representative of what they will be when you level off at cruise speed.
2. Approaching Gulfport, the arrow adjacent to **GPT** begins flashing. This waypoint alert notification begins approximately 20 seconds before the time to start your turn to join the second flight plan leg, **GPT - SJI**. You briefly view the D/T 3 page to see that the next desired track is 61 degrees.

1:KNEW		B→GPT
\rightarrow 2:GPT	+++++↑+++++	
3:SJI	DIS	41.1NM
4:CEW	GS	120KT
5:MAI	ETE	:20
8:KPIE	BRG	054°
FPL 0	ENR-LEG	NAV 1

Figure 4-59

	DIS	ETE
1:KNEW		
\rightarrow 2:GPT	41	:20
3:SJI	83	:41
4:CEW	170	1:25
5:MAI	250	2:05
8:KPIE	484	4:02
FPL 0	ENR-LEG	D/T 1

Figure 4-60

3. As you pass abeam GPT, the leg orientation automatically changes to the second leg (figure 4-61).
4. After joining the second leg of the flight plan, you view the D/T 1 page to see that the ETE to **SJI** is 14 minutes and that the ETE to your destination is 2 hours and 28 minutes. The D/T 2 page indicates you should arrive over **SJI** at 9:37 am Central Standard Time and at **KPIE** at 11:51 am. Since **KPIE** is on Eastern Standard Time, you use the right cursor and right inner knob to change the time zone to **EST** (figure 4-62). You may decide a better alternative is to select Coordinated Universal Time (UTC, which is also called Zulu time). In addition, you briefly check the D/T 4 page to get a display of your departure time, the actual time, the flight time so far, and the ETA and ETE to **KPIE** (figure 4-63).
5. Just prior to reaching Semmes (**SJI**) the waypoint alert notification begins flashing to indicate the upcoming arrival at Semmes. A few seconds later you view a message on the Message page stating: **ADJ NAV IND CRS TO 85°**. This is your notification that there is a course change of at least 5° and that you should set the course pointer on your HSI or CDI to 85°. You should immediately begin a turn to intercept the new desired track of 85°.
6. About 80 NM from Crestview (**CEW**), you decide to view the Super NAV 5 page with the 160 NM range scale selected (figure 4-64). The track up map orientation (**TK↑**) has been selected on the Super NAV 5 page.
7. As your aircraft continues toward Crestview, you decide to take advantage of the moving map display capability of the Super NAV 5 page. While on the 60 nm range of the Super NAV 5 page, you press the right **▀** to bring the menu selection on the page as you learned in section 3.9.7. Using the right inner knob you select low and high altitude VORs. Pressing the right **▀** once again removes the menu from the page and Monroeville (**MVC**), Saufley (**NUN**), and Brookley (**BFM**) VORs are now displayed on the map (figure 4-65).

1:KNEW	DIS	ETE
2:GPT		
3:SJI	42	:14
4:CEW	129	:43
5:MAI	209	1:09
8:KPIE	443	2:28
FPL 0 ENR-LEG		D/T 1

Figure 4-61

1:KNEW	DIS	EST
2:GPT		
3:SJI	42	10:37
4:CEW	129	11:06
5:MAI	209	11:33
8:KPIE	443	12:51
FPL 0 ENR-LEG		D/T 2

Figure 4-62

	KPIE	EST
DEP	10:02	
TIME	10:23	
ETA	12:51	
FLT	:21	
ETE	2:28	
		D/T 4

Figure 4-63

79.0 NM	
CEW	MAI
ENR-LEG	
180 KT	CEW
ETE0:26	
DTK085°	SJI
TK085°	160

Figure 4-64

57.5 NM	
CEW	
ENR-LEG	
180 KT	MVC
ETE0:19	NUN
DTK086°	
TK085°	BFM
60	

Figure 4-65

8. When you are 20 NM West of **MAI**, you decide to proceed direct to Cross City VOR (**CTY**). To do this from the Super NAV 5 page, you pull out the right inner knob and scan through the active flight plan until **CTY** is displayed (figure 4-66). Next, you press **ENT** to view the waypoint page for **CTY**, and then press **ENT** to navigate directly to **CTY** (figure 4-67).
9. Over **CTY** you check the weather and determine that it is currently marginal VFR at St. Petersburg and that you may have to shoot the ILS 17L approach. You add **CAPOK**, the outer compass locator for runway 17L, to your flight plan using the same procedure as described in section 4.1.3 (figure 4-68).
10. To prepare yourself for the arrival into St. Petersburg/Clearwater International airport, you familiarize yourself with the database information for **KPIE**. The easiest way to do this is to select the ACT pages on the right side. If necessary, scan the waypoints in the active flight plan by first pulling the right inner knob to the "out" position. Then, rotate it to view the desired waypoint. For **KPIE**, push the right inner knob back to the "in" position and rotate it to display the eight airport pages.
11. By the time you get to the St. Petersburg terminal area, the weather has cleared so that an instrument approach is not necessary. You delete **CAPOK** from the flight plan exactly as described in section 4.1.4.

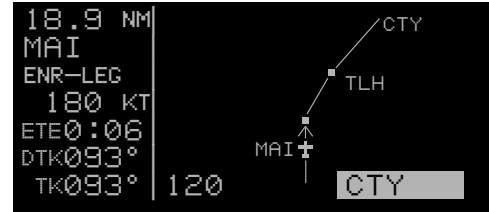

Figure 4-66

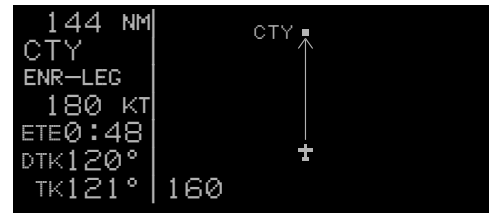

Figure 4-67



Figure 4-68

CHAPTER 5 - LEVEL 3 OPERATION

This is the third of four chapters specifically dealing with operating the KLN 90B. In this chapter you will learn to use many of the supplementary features of the KLN 90B. These include such things as the Advisory VNAV,

the Trip Planning pages, the Calculator pages, and other features that you may find very beneficial and convenient to use in your flying.

5.1 TRIP PLANNING

There are seven Trip Planning pages (**TRI**) that can be displayed on the left side of the screen. The KLN 90B allows three kinds of trip planning. The TRI 1 and TRI 2 pages team together to provide trip planning from your present position to any waypoint of your choice. The TRI 3 and TRI 4 pages provide trip planning between any two waypoints, and the TRI 5 and TRI 6 pages provide an analysis of any of the 26 flight plans (FPL 0, FPL 1, FPL 2, ..., FPL 25) stored in the Flight Plan pages. The TRI 0 page is used to enter estimates of your true airspeed and of the winds so that the KLN 90B can perform wind triangle calculations for use on the other Trip Planning pages.

Data entered on any of the Trip Planning pages has no effect on navigation data provided on any Navigation (NAV) or Flight Plan (FPL) pages. You may perform trip planning without disturbing ongoing navigation.

NOTE: *The Trip Planning pages rely on pilot enterable inputs for true airspeed, groundspeed, and fuel flow. These pages do not utilize inputs from fuel flow or air data sensors. Fuel management and air data pages are discussed in section 5.10 and 5.11.*

NOTE: *Areas of special use airspace are displayed on the Trip Planning pages without regard to altitude.*

5.1.1 The Trip Planning 0 Page (TRI 0)

If desired, you may enter the aircraft's true airspeed (TAS) and the winds aloft on the TRI 0 page so that this information is utilized on the other Trip Planning pages. The KLN 90B uses the TAS and winds entered on the TRI 0 page to calculate your estimated groundspeed for specific trip planning routes you enter on the other Trip Planning pages.

To enter data on the TRI 0 page:

1. Select the TRI 0 page on the left side (figure 5-1).
2. Press the left █ to turn on the left cursor function.
3. Enter the aircraft's true airspeed by using the left outer knob to move the cursor to the desired location and the left inner knob to select each individual digit (figure 5-2).
4. Rotate the left outer knob clockwise to position the cursor over the first two digits of the wind direction (figure 5-3).
5. Turn the left inner knob to select the first two digits of the wind direction (figure 5-4).
6. Rotate the left outer knob one step clockwise to position the cursor over the last digit of the wind direction, and then use the left inner knob to complete the winds direction entry.
7. Enter the wind speed by using the left outer knob to move the cursor and the left inner knob to select each individual digit (figure 5-5).
8. Press the left █ to turn off the left cursor function.

Let's say you enter a TAS of 200 knots and winds of 180 degrees at 25 knots on the TRI 0 page. If you entered two waypoints on the TRI 3 page (trip planning between two waypoints) and the bearing from the first waypoint you entered to the second was 180 degrees, then the TRI 3 page would contain a groundspeed of about 175 knots. The reason we say **about** 175 knots is that the direction of the winds you enter are relative to true North and the bearing displayed is relative to magnetic North. Remember that winds information you get from a Flight Service Station or from an ATC facility is always provided relative to true North. On the TRI 5 and TRI 6 pages (trip planning for a flight plan), the winds are applied to each individual leg of the flight plan.



Figure 5-1



Figure 5-2



Figure 5-3



Figure 5-4



Figure 5-5

**5.1.2 The Trip Planning 1 And Trip Planning 2 Pages
(TRI 1 and TRI 2)**

The TRI 1 and TRI 2 pages allow trip planning from your present position to any waypoint of your choice. Unlike the other Trip Planning pages, in order to utilize the TRI 1 and TRI 2 pages, the KLN 90B must either be receiving GPS signals sufficient to be in the NAV ready status or the KLN 90B must be in the take-home mode.

The TRI 1 page provides estimates of distance, estimated time enroute, bearing, and fuel requirements. The TRI 2 page displays the minimum enroute safe altitude (ESA) and any areas of special use airspace that lay between your present position and the selected waypoint. The TRI 1 and TRI 2 pages are useful, for example, while you are airborne and wish to determine distance, time, fuel, and altitude requirements direct to an alternate location.

NOTE: Prior to using the TRI 1 and TRI 2 pages while the KLN 90B is in the take-home mode, use the SET 1 page to enter your present position. See section 3.6, "INITIALIZATION AND TIME TO FIRST FIX", for an explanation of entering position on the SET 1 page.

For the following example let's say the aircraft is located over Battle Mountain VOR (BAM) enroute to Lake Tahoe and you wish to perform trip planning back to Salt Lake City International airport (KSLC). To perform trip planning on the TRI 1 and TRI 2 pages:

1. Use the left outer knob to select the TRI type pages on the left side.
2. Rotate the left inner knob to display the TRI 1 page on the left side (figure 5-6).
3. Press the left █ to turn on the left cursor function. The cursor will be over the waypoint identifier at the top of the page.
4. Use the left inner and outer knobs to enter the identifier of the selected waypoint (figure 5-7).
5. Press █ to view the waypoint page for the selected waypoint on the right side.
6. Press █ again to acknowledge the waypoint page. The distance, bearing, and estimated time enroute are now displayed (figure 5-8).

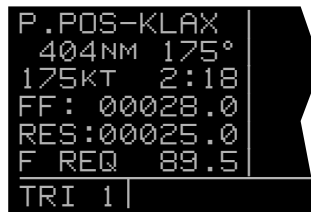

Figure 5-6

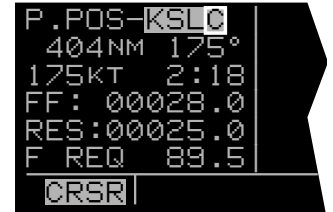

Figure 5-7



Figure 5-8

If you entered true airspeed and wind velocity information on the TRI 0 page, the groundspeed displayed is a result of those inputs applied to the direction of flight specified on the TRI 1 page. You may also enter any groundspeed you desire by using the left outer knob to position the cursor over each digit of the groundspeed and using the left inner knob to select each individual digit.

7. You can also calculate an estimate of the fuel required to the selected waypoint. Turn the left outer knob to position the cursor over the appropriate first digit adjacent to fuel flow (**FF**).
8. Use the left inner and outer knobs as before to enter the aircraft's rate of fuel flow. The unit (gallons, pounds, etc.) is not important as long as you are consistent (figure 5-9).
9. Use the left inner and outer knobs to enter the amount of reserve fuel (**RES**) desired when you reach the selected waypoint (figure 5-10). The estimated amount of fuel required (**F REQ**) to fly to the selected waypoint with the specified reserve is now displayed. Entering the fuel flow and reserve fuel on the TRI 1 page also inputs this same information on the TRI 3 and TRI 5 pages.
10. Press the left █ to turn off the left cursor function.
11. Select the TRI 2 page (figure 5-11). The minimum enroute safe altitude (ESA) and a listing of areas of special use airspace along the route are displayed. If all of the areas of special use airspace won't fit on one page, there will be multiple TRI 2 pages indicated by **TRI+2**.

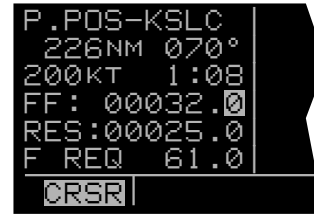

Figure 5-9

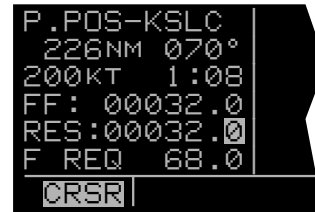

Figure 5-10

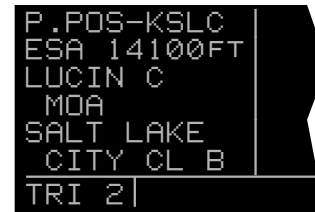

Figure 5-11

**5.1.3 The Trip Planning 3 And Trip Planning 4 Pages
(TRI 3 and TRI 4)**

The TRI 3 and TRI 4 pages allow trip planning between any two waypoints. The KLN 90B does not have to be receiving GPS signals or even be connected to an antenna in order to utilize these pages. To use the TRI 3 and TRI 4 pages:

1. Select the TRI 3 page on the left side (figure 5-12).
2. Press the left **█** to turn on the left cursor function. The cursor will be located over the “from” waypoint identifier (figure 5-13).
3. Use the left inner and outer knobs to enter the identifier of the “from” waypoint (figure 5-14).
4. Press **█** to view the waypoint page on the right side for the waypoint just entered.
5. Press **█** to approve the waypoint page. The cursor will be positioned over the “to” waypoint identifier (figure 5-15).
6. Use the left inner and outer knobs to enter the identifier of the “to” waypoint.
7. Press **█** to view the waypoint page on the right side for the waypoint just entered.
8. Press **█** to approve the waypoint page. The distance, bearing, and estimated time enroute are now displayed (figure 5-16).

If you entered true airspeed and wind velocity information on the TRI 0 page, the groundspeed displayed is a result of those inputs applied to the direction of flight specified on the TRI 3 page. You may also enter any groundspeed you desire by using the left outer knob to position the cursor over each digit of the groundspeed and using the left inner knob to select each individual digit.

If data is entered for fuel flow (**FF**) and reserve fuel (**RES**), as described for the TRI 1 page, the fuel required for the trip is now displayed. Fuel flow and reserve fuel entries made on the TRI 3 page also input this same data on the TRI 1 and the TRI 5 pages.

9. Turn off the left cursor function and then select the TRI 4 page (figure 5-17). The minimum enroute safe altitude (**ESA**) and a listing of areas of special use airspace along the route are displayed. If all of the areas of special use airspace won't fit on one page, there will be multiple TRI 4 pages by **TRI+4**.

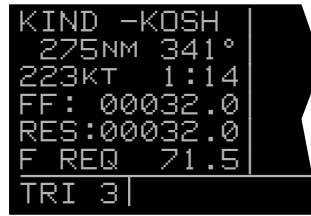

Figure 5-12

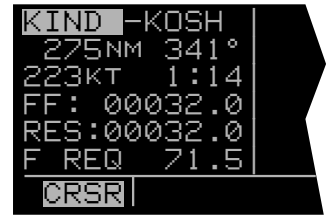

Figure 5-13

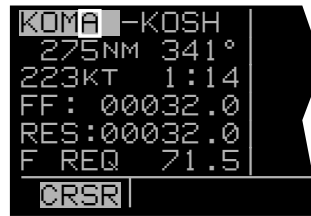

Figure 5-14

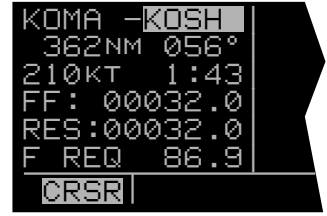

Figure 5-15

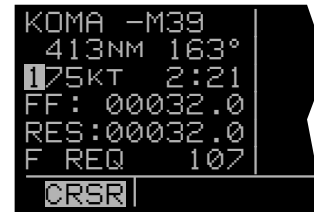



Figure 5-16



Figure 5-17

**5.1.4 The Trip Planning 5 And Trip Planning 6 Pages
(TRI 5 and TRI 6)**

The TRI 5 and TRI 6 pages are used to do trip planning for any one of the previously entered flight plans (FPL 0, FPL 1, FPL 2, ..., FPL 25). The KLN 90B does not have to be receiving GPS signals or even be connected to an antenna in order to utilize these pages. To use the TRI 5 and TRI 6 pages:

1. Select the TRI 5 page on the left side (figure 5-18).
2. Press the left  to turn on the left cursor function. The cursor will be located over the flight plan number.
3. Rotate the left inner knob to select the desired flight plan to be analyzed (figure 5-19). The first and last waypoints in the selected flight plan are displayed on the second line. The distance and estimated time enroute are also displayed. There is no bearing display since the flight plan can have up to 30 waypoints which creates 29 flight plan legs.

If you entered true airspeed and wind velocity information on the TRI 0 page, the groundspeed displayed is the average groundspeed for the flight plan. It is the result of the true airspeed and wind velocity entered on the TRI 0 page applied to each leg of the flight plan. You may also enter any groundspeed you desire by using the left outer knob to position the cursor over each digit of the groundspeed and using the left inner knob to select each individual digit.

If data is entered for fuel flow (FF) and reserve fuel (RES), as described for the TRI 1 page, the fuel required for the trip is now displayed. Fuel flow and reserve fuel entries made on the TRI 5 page also input this same data on the TRI 1 and the TRI 3 pages.

4. Turn off the left cursor function and then select the TRI 6 page (figure 5-20). The minimum enroute safe altitude (ESA) and a listing of areas of special use airspace along the flight plan route are displayed. If all of the areas of special use airspace won't fit on one page, there will be multiple TRI 6 pages indicated by **TRI+6**.

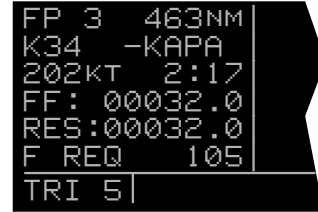

Figure 5-18

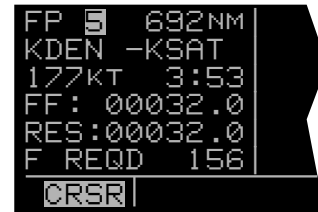

Figure 5-19



Figure 5-20

5.2 ADVISORY VNAV OPERATION

The KLN 90B's vertical navigation feature (VNAV) allows you to program a descent or ascent path, and then provides you with an advisory altitude to fly that will provide guidance along the vertical path. For example, you can program the VNAV to provide descent guidance so that you arrive at your active waypoint or a waypoint in the active flight plan at an altitude that you specify. The KLN 90B will alert you of when to start the descent, and display the advisory altitudes to fly throughout the descent.

5.2.1 VNAV For Direct To Operation

The Navigation 4 (**NAV 4**) page is used to program the KLN 90B for vertical navigation. The following example will be used to illustrate how to use the VNAV feature. You are using the KLN 90B to fly direct to your destination airport, Dubuque Municipal airport (**KDBQ**) located in Dubuque, Iowa. You are presently about 65 nm West of Dubuque, flying at 7500 feet MSL (figure 5-21). You desire to use the VNAV to provide vertical guidance to Dubuque's traffic pattern altitude of 1900 feet MSL.

1. Select the NAV 4 page on either side of the screen (figure 5-22). You can select the NAV 4 page either by using the knobs or by pressing **■** to bring up the NAV 4 page on the right side and the ALT page on the left. The aircraft's actual altitude is displayed in the **IND** field. If the displayed altitude is incorrect it is probably because you have not recently updated the KLN 90B's altimeter baro setting on the ALT page (see section 3.15).

NOTE: There may be some difference (less than 100 feet) between the indicated altitude (**IND**) and the aircraft's actual altitude if the altitude input to the KLN 90B is from an altitude encoder because these encoders only provide altitude in 100 foot increments.

The identifier for the active waypoint (**KDBQ**) is automatically displayed on the NAV 4 page. Prior to programming a VNAV operation, the top of the page displays that the VNAV is inactive (**VNV INACTV**).

2. Press the appropriate **■** button to turn on the cursor function if it is not already on (figure 5-23).
3. Enter the desired altitude of 1900 feet in the **SEL** field. The outer knob is used to move the cursor and the inner knob is used to select the digits. The altitude may be entered in 100 foot increments (figure 5-24).

NOTE: If the KLN 90B does not have an altitude input, the **IND** and **SEL** fields will be labeled **FR** (from) and **TO** respectively. The aircraft's present altitude must be entered into the **FR** field and the desired altitude into the **TO** field.



Figure 5-21



Figure 5-22

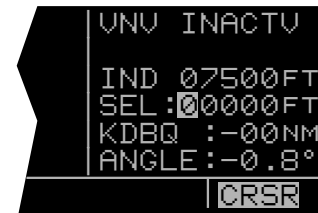

Figure 5-23

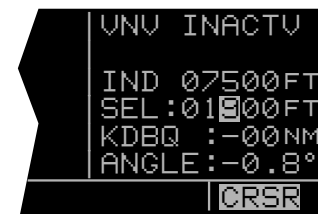

Figure 5-24

- Use the outer knob to move the cursor to the offset field adjacent to the active waypoint identifier. Entering an offset allows you to reach the desired altitude a specified distance before reaching the waypoint. In this example you desire to reach traffic pattern altitude two nautical miles prior to the airport, which allows sufficient time to slow down and prepare for the landing. Enter an offset of 2 nm (figure 5-25).

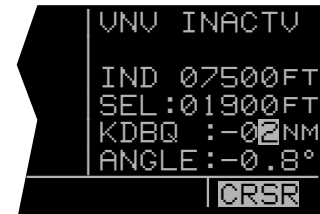

Figure 5-25

Notice that the bottom of the NAV 4 page now displays an angle. If you wish to start your descent now using the displayed descent angle, use the outer knob to position the cursor over the **ANGLE** field (figure 5-26). VNAV operation is initiated by bringing the cursor over the **ANGLE** field. Or, by leaving the cursor off of the **ANGLE** field, you may watch the VNAV angle increase as you fly toward your waypoint. When the desired angle is reached, position the cursor over the **ANGLE** field and VNAV will commence. When VNAV begins, the top of the page displays an advisory altitude. Just start a rate of descent so that the aircraft's altimeter matches the advisory altitude.



Figure 5-26

A better way yet to initiate VNAV is to program a desired angle to use for the descent. If you are not sure what a suitable descent angle is, use the CAL 4 page to calculate one for you. The CAL 4 page is described in section 5.3.4. After a little experience using the VNAV feature, you will soon learn what angles to use for your normal speeds and rates of descent. To program a descent angle:

- Use the outer knob to move the cursor to the **ANGLE** field, and then enter the desired descent angle (figure 5-27). If the time to begin your descent is greater than ten minutes, **VNV ARMED** will now be displayed on the top line of the NAV 4 page. If the time is less than ten minutes, the top line displays a countdown to the time to begin the descent.
- Return to any desired page for now. If you got to the NAV 4 page by pressing **ENT**, press **ENT** once again to return to the pages previously in view. If you got to the NAV 4 page using the inner and outer knobs, press **CLR** to turn off the cursor function and then use the inner and outer knobs to select the desired page. Approximately 90 seconds before the time to begin descent, the message prompt will flash. When you view the Message page, it will display "**VNAV ALERT**". This is notification for you to view the NAV 4 page because it is getting close to the time to begin your descent.
- When the countdown reaches 0:00, the time will be replaced with an advisory altitude (figure 5-28). Begin your rate of descent so that the altitude displayed on your altimeter matches the advisory altitude.

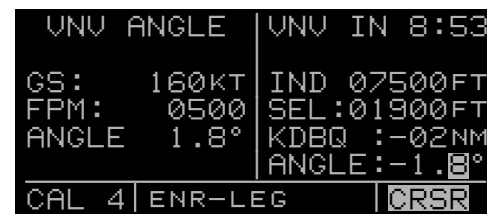

Figure 5-27

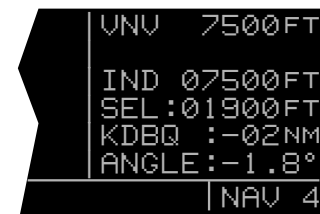

Figure 5-28

5.2.2 VNAV For Flight Plan Operation

Using the vertical navigation function when flying via a flight plan is virtually the same as for the previous Direct To example. The NAV 4 page will initially contain the identifier for the active “to” waypoint in the flight plan. You may program the vertical ascent or descent referencing this waypoint **or you may enter the identifier for any waypoint in the active flight plan which is still in front of the aircraft’s position.** When another valid waypoint in the flight plan is entered on the NAV 4 page, the aircraft’s lateral flight path is not altered. This means that you may program a vertical flight path having an ascent or descent point that begins prior to the flight plan leg containing the selected VNAV waypoint.

5.2.3 VNAV From the Super NAV 5 Page

The Super NAV 5 page can be configured to display the VNAV status. This means that you will not have to change pages to see what altitude you should be at. You will still need to set up the VNAV problem by using the NAV 4 page as described in section 5.2.1. To use the Super NAV 5 page to view the VNAV status use the following steps.

1. Set up the VNAV situation from the NAV 4 page.
2. Turn to the Super NAV 5 page by selecting NAV 5 on both sides of the display.
3. Turn on the left cursor and rotate the left outer knob counter-clockwise until the cursor is over the third line from the bottom of the display (figure 5-28a).
4. Rotate the left inner knob until “VNAV” is displayed (figure 5-28b). Turn the left cursor off by pressing the left █.
5. The Super NAV 5 page will now display the VNAV status. If the VNAV problem has not been defined yet, then **V OFF** will be displayed. If the time to start VNAV operation is greater than 10 minutes then **V ARM** is displayed. When the time to VNAV operation is less than 10 minutes then the Super NAV 5 page will display the time until VNAV operation will start. For example, **V 4:53** would be displayed if the time until VNAV operation is 4 minutes and 53 seconds. If the VNAV function has started and is suggesting an altitude then the Super NAV 5 display will display this altitude. For example **V 4300** would be displayed if the suggested altitude was 4300 feet.

NOTE: If you used the CAL 4 page to determine the ascent/descent angle, the aircraft’s groundspeed during the ascent/descent should match that entered on the CAL 4 page. If a different groundspeed is actually flown, a different rate of ascent/descent from the one entered on the CAL 4 page will be required.



Figure 5-28a

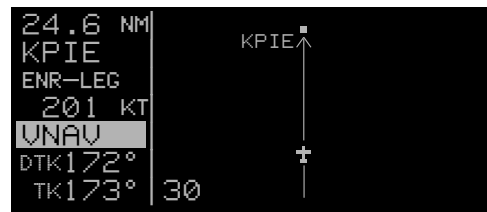

Figure 5-28b

CAUTION: Advisory VNAV operation will only be accurate if the altimeter baro correction is kept updated. If advisory VNAV is used, it is a good idea to update the altimeter baro set on the ALT page each time you make a change to the aircraft’s altimeter setting.

5.3 CALCULATOR PAGES

There are seven Calculator pages which may be used to calculate a variety of flight related information such as pressure and density altitude, true airspeed, winds aloft, VNAV angle, and time zone conversions. The Calculator pages allow you to make “what if” calculations for conditions other than the present situation. Therefore, the Calculator pages rely on you to make manual inputs of air data parameters such as altitude and true airspeed even if the KLN 90B is interfaced to air data sensors. If the KLN 90B is interfaced with a compatible air data system, the Other 9 and Other 10 (**OTH 9** and **OTH 10**) pages display the air data information directly.

5.3.1 The Calculator 1 Page (CAL 1)

The CAL 1 page is used to determine pressure altitude and density altitude. To calculate these values:

1. Display the CAL 1 page on the left side (figure 5-29).
2. Press the left **■** to turn on the left cursor function.
3. Enter the altitude indicated on the aircraft’s altimeter (**IND**) to the nearest hundred feet by using the left outer knob to move the cursor to the desired position and the left inner knob to select each digit (figure 5-30).
4. Use the left outer knob to move the cursor to the first **BARO** position, and then enter the current altimeter setting by using the left inner and outer knobs (figure 5-31). The pressure altitude is now displayed (**PRS**).

NOTE: The SET 7 page (figure 5-32) is used to select whether the altimeter setting on the CAL 1 page is made in inches of Mercury (") or millibars (MB). To change the altimeter setting from inches to millibars, or vice versa, select the SET 7 page, press the left **■**, and rotate the left inner knob to make your selection. When finished, press the left **■** to turn off the cursor function.

NOTE: Some areas of the world use hectopascals as a barometric unit. Hectopascals are numerically the same as millibars so choose millibars as the barometric unit in these areas.

5. Use the left outer knob to move the cursor to the first **TEMP** position, and then enter the outside air temperature (degrees C) by using the left inner and outer knobs (figure 5-33). The first digit of the temperature is either “0” if the temperature is above zero or “-” if the temperature is below zero. For maximum accuracy, the static air temperature should be entered. This is the temperature of air without the effect of heating due to movement through the air. For the airspeeds of most piston aircraft, the difference between static air temperature and the observed air temperature (or “total air temperature”) is negligible.

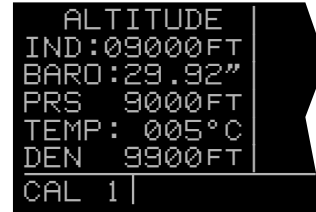

```
ALTITUDE
IND:09000FT
BARO:29.92"
PRS  9000FT
TEMP: 005°C
DEN  9900FT
CAL 1 |
```

Figure 5-29

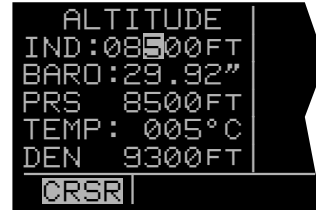

```
ALTITUDE
IND:08500FT
BARO:29.92"
PRS  8500FT
TEMP: 005°C
DEN  9300FT
CRSR |
```

Figure 5-30



```
ALTITUDE
IND:08500FT
BARO:30.04"
PRS  8400FT
TEMP: 005°C
DEN  9200FT
CRSR |
```

Figure 5-31



```
BARO SET
UNITS
"
INCHES
SET 7 |
```

Figure 5-32



```
ALTITUDE
IND:08500FT
BARO:30.04"
PRS  8400FT
TEMP: 000°C
DEN  9300FT
CRSR |
```

Figure 5-33

The density altitude (**DEN**) is now displayed.

6. Press the left **■** to turn off the left cursor function.

NOTE: If a compatible air data system is interfaced to the KLN 90B the Other 10 (**OTH 10**) page displays pressure and density altitude directly for the present conditions.

5.3.2 The Calculator 2 Page (CAL 2)

The CAL 2 page is used to determine the true airspeed (**TAS**) of the aircraft. To calculate the true airspeed:

1. Select the CAL 2 page on the left side (figure 5-34).
2. Press the left **■** to turn on the left cursor function.
3. Enter the aircraft's calibrated airspeed by using the left inner and outer knobs (figure 5-35). If the calibrated airspeed isn't known, use the indicated airspeed. For most aircraft the difference between the calibrated airspeed and the indicated airspeed is small at cruise airspeeds.
4. Use the left outer knob to move the cursor to the first **ALT** position, and then enter the aircraft's indicated altitude using the left inner and outer knobs. If the indicated altitude was previously entered on the CAL 1 page, it will already be displayed.
5. Turn the left outer knob to move the cursor to the first **BARO** position and then enter the current altimeter setting using the left inner and outer knobs. If the altimeter setting was made on the CAL 1 page, it will already be displayed. The SET 7 page is used to select between making the altimeter setting in inches of mercury ("") or millibars (MB).
6. Rotate the left outer knob to move the cursor to the first **TEMP** position, and then enter the outside air temperature (degrees C) by using the left outer and inner knobs (figure 5-36). The first digit of the temperature is either "0" if the temperature is above zero or "-" if the temperature is below zero. For maximum accuracy, the "total air temperature" should be entered. This is the temperature of air including the effect of heating due to movement through the air. The temperature read on a standard outside air temperature gauge found on most piston aircraft is "total air temperature". Note that because of the two types of temperature, a temperature entry made on the CAL 1 page is not transferred to the CAL 2 page.
The true airspeed (**TAS**) is now displayed.
7. Press the left **■** to turn off the left cursor function.

NOTE: If a compatible air data system is interfaced to the KLN 90B, true airspeed (**TAS**) is displayed directly on the Other 9 (**OTH 9**) page for the present conditions.

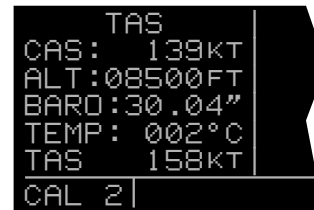

Figure 5-34



Figure 5-35



Figure 5-36

5.3.3 The Calculator 3 Page (CAL 3)

The CAL 3 page is used to determine the present wind direction and speed. In addition, the headwind or tailwind component of the wind is displayed. To calculate these values:

1. Select the CAL 3 page on the left side (figure 5-37).
2. Press the left  to turn on the left cursor function.
3. Enter the aircraft's true airspeed (**TAS**) by using the left inner and outer knobs. If the CAL 2 page was previously used to calculate true airspeed, it will already be displayed.
4. Use the left outer knob to move the cursor to the first **HDG** position, and then enter the aircraft's heading using the left inner and outer knobs (figure 5-38). The headwind (**HDWND**) or tailwind (**TLWND**) and the wind direction and speed are now displayed. The wind direction is relative to true North.

NOTE: The wind calculations are only correct when you have entered the correct aircraft heading and true airspeed. Make sure to re-enter new values if you change airspeed or heading.

5. Press the left  to turn off the left cursor function.

NOTE: If the KLN 90B is interfaced with a compatible source of heading information, line three of the CAL 3 page is blank. Heading is then automatically input and used in the wind calculation displayed on the CAL 3 page. If the KLN 90B is interfaced with a compatible air data system in addition to a compatible heading source, the Other 9 (**OTH 9**) page displays wind information directly.

5.3.4 The Calculator 4 Page (CAL 4)

The CAL 4 page is used to determine vertical navigation descent/ascent angles to use on the NAV 4 page. To calculate the required angle:

1. Select the CAL 4 page on the left side (figure 5-39).
2. Press the left  to turn on the left cursor function.
3. Use the left inner and outer knobs to enter what the aircraft's groundspeed will be during the descent or ascent (figure 5-40).
4. Turn the left outer knob to move the cursor to the first **FPM** position, and then enter the desired rate of descent or ascent (in feet per minute) using the left inner and outer knobs (figure 5-41). The descent/ascent angle is now displayed.

In addition, you may enter an angle and determine what rate of descent or ascent will be required for the selected combination of groundspeed and angle.

5. Press the left  to turn off the left cursor function.

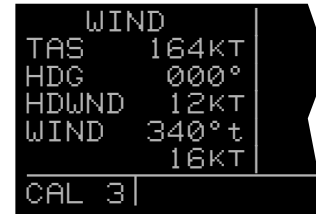

Figure 5-37



Figure 5-38

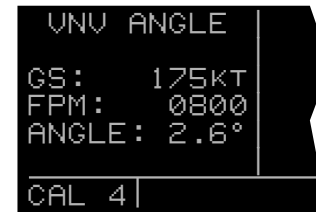

Figure 5-39

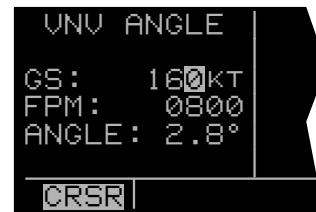

Figure 5-40

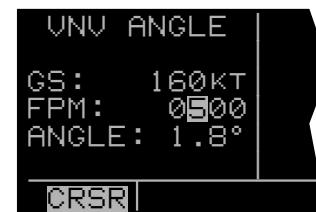

Figure 5-41

5.3.5 The Calculator 5 Page (CAL 5)

The CAL 5 page is used to perform two types of conversions: 1) Degrees Centigrade (C) to degrees Fahrenheit (F) and vice versa and 2) knots (KT) to miles per hour (MPH) and vice versa. To use the CAL 5 page:

1. Display the CAL 5 page on the left side (figure 5-42).
2. Press the left **■** to turn on the left cursor function.
3. To convert degrees C to degrees F, use the left outer knob to position the cursor over the appropriate Centigrade digits and use the left inner knob to select the desired values of temperature. When the desired temperature in degrees C is selected, the corresponding temperature in degrees F is displayed (figure 5-43).

To convert degrees F to degrees C, use the left outer knob to position the cursor over the appropriate Fahrenheit digits and use the left inner knob to select the desired values of temperature. When the desired temperature in degrees F is selected, the corresponding temperature in degrees C is displayed.

To convert knots to miles per hour, use the left outer knob to position the cursor over the appropriate knots digits and use the left inner knob to select the desired values of speed. When the desired speed in knots is selected, the corresponding speed in miles per hour is displayed (figure 5-44).

To convert miles per hour to knots, use the left outer knob to position the cursor over the appropriate MPH digits and use the left inner knob to select the desired values of speed. When the desired speed in miles per hour is selected, the corresponding speed in knots is displayed.

4. Press the left **■** to turn off the left cursor function.

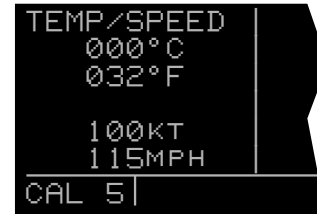

Figure 5-42



Figure 5-43

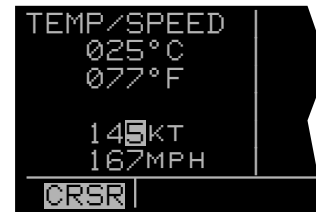

Figure 5-44

5.3.6 The Calculator 6 Page (CAL 6)

The CAL 6 page is used to convert any time in one time zone to the corresponding time in another time zone. A listing of available time zones is contained in section 3.2. For example, if it is presently 9:56 am Pacific Standard Time (PST) and you wished to determine the time in Eastern Standard Time (EST):

1. Select the CAL 6 page on the left side (figure 5-45). The first time the CAL 6 page is viewed after the KLN 90B has been turned on, the top time showing will be the current system time. That is, it will be the same time as displayed on the SET 2 page. Also, the bottom time will be the current time referenced to the Coordinated Universal Time (UTC) time zone. Remember that UTC is the same as "Zulu".
2. Press the left **■** to turn on the left cursor function.
3. Rotate the left outer knob to position the cursor over the top time zone abbreviation (figure 5-46).
4. Turn the left inner knob to select the desired time zone (figure 5-47).
5. Rotate the left outer knob to position the cursor over the bottom time zone abbreviation, and then use the left inner knob to select the desired time zone (figure 5-48). The corresponding time is now displayed.

In addition, you may enter a time different than the actual time in either the top or bottom time display. When either the top or bottom time is changed, the other one also changes to show the correct corresponding time.

6. Press the left **■** to turn off the left cursor function.

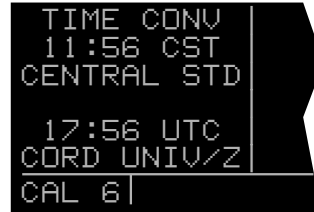

Figure 5-45



Figure 5-46



Figure 5-47



Figure 5-48

5.3.7 The Calculator 7 Page (CAL 7)

The CAL 7 page is used to display the times of sunrise and sunset for any waypoint in the published or user database. It can do this for any date you desire until December 31, 2087. Amazing you say! Yes, but it's true! To use the CAL 7 page:

1. Select the CAL 7 page on the left side (figure 5-49). The first time the CAL 7 page is selected after the KLN 90B is turned on, the waypoint identifier defaults to the current destination, the date defaults to the current date, and the time zone defaults to the system time zone. Each of these three items may, however, be changed. The sunrise and sunset are displayed at the bottom of the page.

NOTE: The time zone initially displayed is the system time zone. This is the same as the one on the SET 2 page. Note that the time zone displayed may not be appropriate for the waypoint shown. For example, the waypoint shown could be **KLAX** and the time zone may be Eastern Standard Time (**EST**). Make sure you select the appropriate time zone for the displayed waypoint.

2. Press the left **█** to turn on the left cursor function.
3. If desired, select another waypoint identifier using the left inner and outer knobs. Press **█** to view the waypoint page for the waypoint entered. Press **█** again to approve the waypoint page (figure 5-50).
4. If desired, select another date using the left inner and outer knobs. You must press **█** to enter the date (figure 5-51).
5. If desired, select another time zone. The sunrise and sunset times for the selected waypoint, date, and time zone are now displayed (figure 5-52).
6. Press the left **█** to turn off the left cursor function.



Figure 5-49

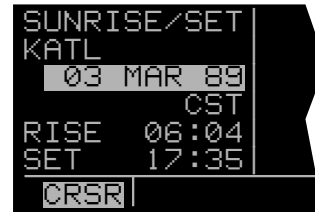

Figure 5-50



Figure 5-51



Figure 5-52

5.4 USER-DEFINED WAYPOINTS

Up to 250 user-defined waypoints may be created. These waypoints may be defined as a user-defined airport, VOR, NDB, or intersection. If the waypoint doesn't fit into one of these categories, it may be defined as a supplemental (SUP) waypoint. An advantage of defining a user waypoint as a supplemental waypoint is that its location may be entered as a radial and distance from a VOR or from any other waypoint in the database.

5.4.1 Creating An Airport User Waypoint

A user defined airport waypoint must contain an identifier, latitude, and longitude. In addition, any combination of airport elevation, one runway length and associated runway surface (hard or soft), and remarks can also be stored. Communication frequencies cannot be stored on the APT 4 page, airport services cannot be stored on the APT 6 page, SIDs and STARs cannot be stored on the APT 7 page, and approach procedures cannot be stored on the APT 8 page. To create a user waypoint as an airport:

1. Use the right outer knob to select the airport (APT) type waypoints.
2. Rotate the right inner knob to select the APT 1 page.
3. Press the right **■** to turn on the right cursor function. The cursor will appear over the first character of the identifier (figure 5-53).
4. The next step is to select the identifier of the user waypoint. The identifier can be one to four characters in length. Use the right inner knob to select the first character of the identifier.
5. Turn the right outer knob one step clockwise to position the cursor over the second character and then use the right inner knob to select the desired character.
6. Use the right outer and inner knobs as described above to finish selecting the identifier (figure 5-54).
7. If you wish to create a waypoint at your present position (the position shown on the NAV 2 page), turn the right outer knob clockwise to position the cursor over **PRES POS?** and press **■**. The APT 1 page will now be displayed with the latitude and longitude of the waypoint at the bottom of the page (figure 5-55).



Figure 5-53



Figure 5-54



Figure 5-55

8. If instead, you wish to create a waypoint at a position that you specify, position the cursor over **USER POS?** and press **■**. A page with the identifier at the top and dashes at the bottom will now be displayed (figure 5-56). The cursor will be over the dashed latitude field. The latitude and longitude of the waypoint must be entered. To do so, turn the right inner knob to display an **N** (for North) or an **S** (for South). Next, select the latitude in degrees, minutes, and hundredths of a minute by using the right outer knob to position the cursor and the right inner knob to select the desired numbers (figure 5-57). When the complete latitude has been selected, press **■**. The cursor will jump down to the longitude field. Turn the right inner knob to select **W** (for West) or **E** (for East). Use the right outer and inner knobs to select the longitude. Press **■** to approve the waypoint position (figure 5-58).

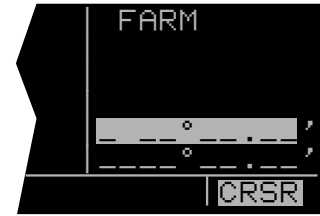

Figure 5-56

9. Turn the right inner knob one step clockwise to display the APT 2 page (figure 5-59). To enter an airport elevation press the right **■** and rotate the right outer knob to position the cursor over the dashes to the right of **ELV**. Use the right outer knob to position the cursor until the entire elevation is selected. Press **■** to store. Press the right **■** to turn off the right cursor function (figure 5-60).

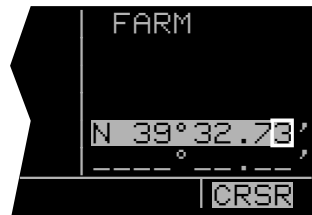

Figure 5-57

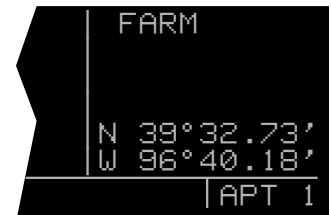

Figure 5-58

10. Turn the right inner knob one step clockwise to display the APT 3 page (figure 5-61). To enter a runway length, press the right **■** and rotate the right outer knob to position the cursor over the five dashes directly beneath **RWY LEN**. Use the right inner knob to select each individual digit and the right outer knob to position the cursor until the entire runway length is selected. Press **■** to approve the runway length. The cursor will move to the surface position. Turn the right inner knob to select either **HRD** (for hard surface) or **SFT** (for soft surface). Press **■** to approve the runway surface. Press the right **■** to turn off the right cursor function (figure 5-62).



Figure 5-59



Figure 5-60



Figure 5-61



Figure 5-62

11. Airport remarks may be stored on the APT 5 page using the procedure described in section 3.11.6, "The Airport 5 Page (APT 5)".

5.4.2 Creating A VOR User Waypoint

A user-defined VOR waypoint must contain an identifier, magnetic variation, latitude, and longitude. The magnetic variation may be manually entered or, if one is not entered, one will automatically be calculated and stored. In addition, a VOR frequency may be stored. The procedure for creating a VOR user waypoint is similar to that just described for creating an airport user waypoint. Begin by selecting the VOR type waypoints instead of the airport type waypoints. The VOR identifier can be one to three characters in length. A VOR user waypoint page that has not yet been defined by the user contains the user identifier at the top of the page and three lines of dashes (figure 5-63). The top line of dashes may be filled in with frequency and magnetic variation. The second line is for latitude and the third line is for longitude (figure 5-64). A user-defined VOR is stored as an "undefined" (U) class.

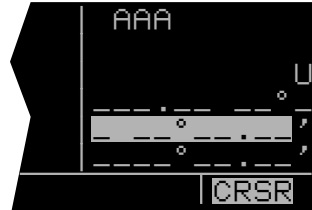

Figure 5-63

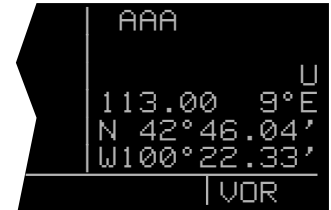

Figure 5-64

5.4.3 Creating An NDB User Waypoint

A user-defined NDB waypoint must contain an identifier, latitude, and longitude. In addition, an NDB frequency may be stored. The procedure for creating an NDB user waypoint is similar to that described for creating an airport user waypoint. Begin by selecting the NDB type waypoints instead of the airport type waypoints. The NDB identifier can be one to three characters in length. An NDB user waypoint page that has not yet been defined by the user contains the user identifier at the top of the page and three lines of dashes (figure 5-65). The top line of dashes may be filled in with the NDB frequency. The second line is for latitude and the third line is for longitude (figure 5-66).



Figure 5-65

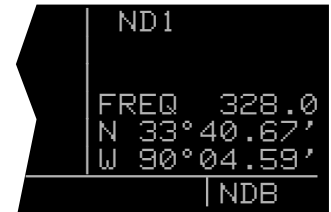

Figure 5-66

5.4.4 Creating Intersection Or Supplemental User Waypoints

A user defined intersection or supplemental waypoint must contain an identifier, latitude, and longitude. The identifier for either can be one to five characters in length. There are two procedures which may be used to define these waypoints. Both procedures begin by selecting the **INT** or **SUP** type waypoints, as appropriate.

The first method is similar to that described for creating an airport, VOR, or NDB user waypoint. Only a latitude and longitude need be entered to complete creating the waypoint.

The second method is to define the waypoint's position in terms of a radial and distance from any other published or previously defined user waypoint. To create a user waypoint in this manner:

1. Use the right outer knob to select **INT** or **SUP** type waypoints, as appropriate (figure 5-67).

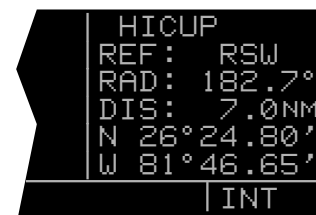

Figure 5-67

2. Use the right **■** and the right inner and outer knobs in the manner previously described in section 5.4.1, "Creating An Airport User Waypoint", to select the waypoint identifier (figure 5-68).



Figure 5-68

3. Rotate the right outer knob to position the cursor over **USER POS?** and press **■**. A user waypoint page will appear with the identifier at the top with the cursor over a dashed latitude field (figure 5-69).

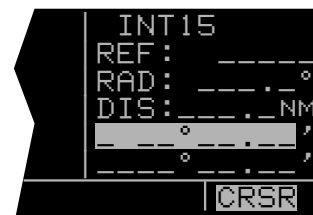

Figure 5-69

4. Turn the right outer knob counterclockwise to position the cursor over the dashes to the right of **REF** (figure 5-70).

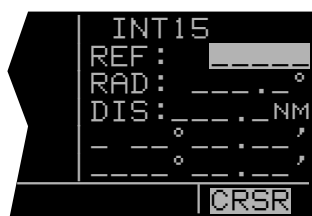

Figure 5-70

5. Rotate the right inner knob to select the first character of an identifier for a "reference waypoint". This waypoint may be any existing waypoint.

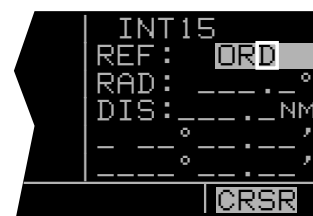

Figure 5-71

6. Use the right outer knob to position the cursor, and the right inner knob to select the characters so that the entire identifier for the reference waypoint is displayed (figure 5-71).

7. Press **■** to see the waypoint page for the reference waypoint just entered.

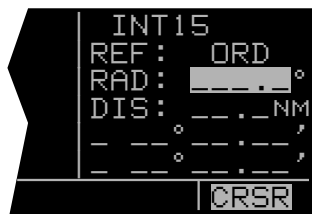

Figure 5-72

8. Press **■** again to approve this waypoint page. The waypoint page being created will return with the cursor over the dashes to the right of **RAD** (figure 5-72).

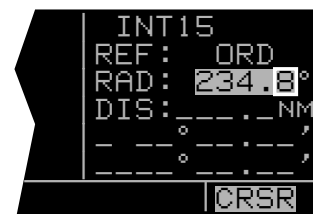

Figure 5-73

9. Use the right inner and outer knobs to select the radial (from the reference waypoint). The radial may be selected to the nearest tenth of a degree (figure 5-73).

10. Press **■**. The cursor will move to the dashes to the right of **DIS**.

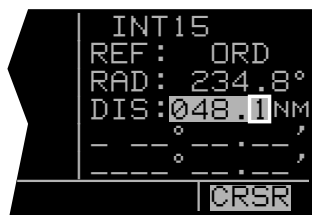

Figure 5-74

11. Use the right inner and outer knob to select the distance. The distance may be selected to the nearest tenth of a nautical mile (figure 5-74).

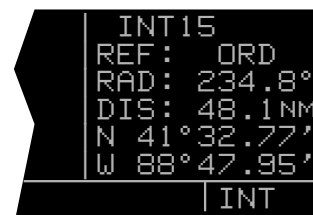

Figure 5-75

12. Press **■**. The latitude and longitude is calculated and displayed. The user waypoint is now defined (figure 5-75).

NOTE: Entering the reference waypoint, radial, and distance is done only to define the user waypoint's latitude and longitude position. The reference waypoint, radial, and distance are not stored as part of the user waypoint. As soon as another page is viewed on the right side, these parameters are lost. If the waypoint page for a user-defined intersection or Supplemental waypoint is viewed later on, it will display the radial and distance from the VOR nearest the user-defined waypoint (figure 5-76). The original reference waypoint may be re-entered at any time.

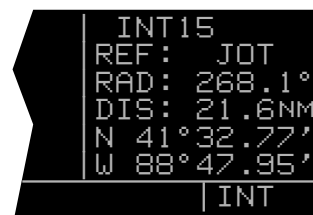

Figure 5-76

5.4.5 Deleting User-Defined Waypoints

A listing of all user-defined waypoints is contained on the Other 3 page (**OTH 3**). See figure 5-77. The user-defined waypoints are listed by category; airports (**A**) are first, VORs (**V**) are second, NDBs (**N**) are third, intersections (**I**) are fourth, and Supplemental waypoints (**S**) are last. Within each category, the waypoints are alphabetized by identifier. To the right of the identifier is the type waypoint defined (**A**, **V**, **N**, **I**, or **S**). If the waypoint is used in a flight plan, the flight plan number is shown to the right of the waypoint type. If more than five user waypoints exist, it is necessary to press the left **ENT** and then use the left outer knob to scroll through the complete list. To delete a user waypoint:

1. Select the OTH 3 page.
2. Press the left **ENT** and use the left outer knob to move the cursor over the waypoint to be deleted (figure 5-78). If more than five user-defined waypoints exist, it is necessary to use the left outer knob to scroll through the complete list. A waypoint contained in a flight plan cannot be deleted without first either deleting the waypoint from the flight plan or deleting the entire flight plan.
3. Press **CLR** (figure 5-79). The waypoint page for the waypoint to be deleted appears on the right side.
4. Press **ENT** (figure 5-80).
5. Press the left **ENT** to turn off the left cursor function.

USER	WPTS	
FARM	A	6
L29	A	24
AAA	V	
ND1	N	
INT15	I	
OTH 3		

Figure 5-77

USER	WPTS	
FARM	A	6
L29	A	24
AAA	V	
ND1	N	
INT15	I	
CRSR		

Figure 5-78

DEL	ND1	?	ND1
FARM	A	6	
L29	A	24	
AAA	V		FREQ 328.0
ND1	N		N 33°40.67'
INT15	I		W 90°04.59'
CRSR		ENR-LEG	ENT NDB

Figure 5-79

USER	WPTS	
FARM	A	6
L29	A	24
AAA	V	
INT15	I	
ADMA	S	4
CRSR		

Figure 5-80

5.5 REFERENCE WAYPOINTS

Creating a Reference Waypoint is a method of adding a waypoint to any flight plan. The Reference Waypoint lies on the great circle route between two other waypoints in the flight plan. The point where the Reference Waypoint lies on the great circle route is the point where the route passes closest to a point that you designate. The feature may be utilized on the ground as an aid in defining a route before filing a flight plan, or in the air as an easy way to comply with an ATC request for additional waypoints. It is also useful, at times, to use the Reference Waypoint feature just to see how close your flight will come to some point that you designate. An example will illustrate the Reference Waypoint feature.

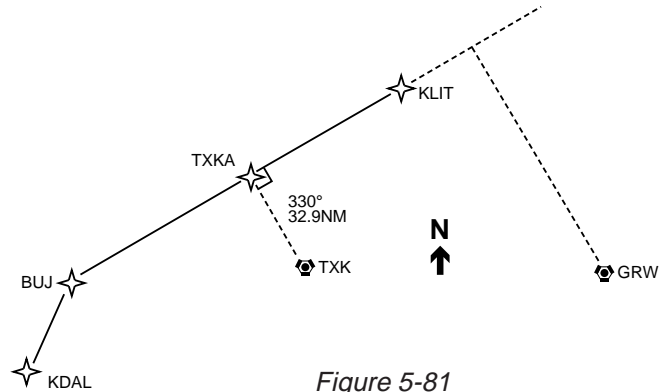

Figure 5-81

A flight plan is created from Dallas Love airport (KDAL) in Dallas, Texas to Adams Field (KLIT) in Little Rock, Arkansas. Blue Ridge VOR (BUJ) is added as a departure waypoint outside the Dallas-Ft. Worth Class B airspace. You desire to add a waypoint to your flight plan approximately half way between the 223 nautical mile distance from BUJ to KLIT. Looking at your chart, you determine that Texarkana VOR (TXK) is in the vicinity of your route, but appears to be a little South of the route. Since you don't want to fly any out of your way, you decide to create a reference waypoint using TXK.

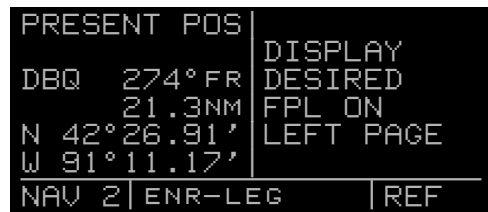

Figure 5-82

1. Select the Reference Waypoint (REF) page on the right side. If a flight plan page is not displayed on the left side, the REF page looks like the one in figure 5-82.
2. Display the desired flight plan on the left side (figure 5-83). The Reference Waypoint feature may be used on the active flight plan or on any of the 25 numbered flight plans that contain at least two waypoints.
3. Press the right █ to turn on the right cursor function.
4. Use the right inner and outer knobs to enter the identifier of the desired waypoint (figure 5-84).

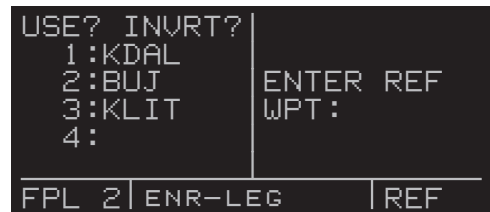

Figure 5-83

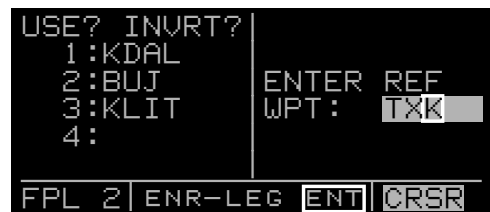

Figure 5-84

NOTE: The waypoint which is used to create the Reference Waypoint may be in the published or user database. This waypoint must be located relative to the flight plan such that it is possible to draw a perpendicular line from this waypoint to a segment of the flight plan. figure 5-81 shows that TXK is an acceptable waypoint to use in creating a Reference Waypoint. figure 5-81 also shows that Greenwood VOR (GRW) would not be an acceptable waypoint since a perpendicular line can be drawn to an extension of the flight plan, but not to the flight plan itself.

5. Press **■** to display the waypoint page for the waypoint just entered.
6. Press **■** again to display the waypoint page for the newly created Reference Waypoint (figure 5-85). The waypoint that was used to create the Reference Waypoint is automatically inserted into the **REF** field. The radial and distance as well as the latitude and longitude are also displayed. The left side of the screen shows where the Reference Waypoint will be inserted in the flight plan.

```

USE? INVRT? | TXKA
1:KDAL      | REF:  TXK
2:BUJ       | RAD: 330.3°
3:TXKA      | DIS: 32.8NM
4:KLIT      | N 34°01.08'
5:          | W 94°19.67'
-----
| CRSR | ENR-LEG | ENT | SUP

```

Figure 5-85

The KLN 90B automatically names the Reference Waypoint by appending the first available alphabetic character to the identifier of the waypoint which you entered. Thus, **TXK** becomes **TXKA** in this case. If you later use **TXK** to create a Reference Waypoint in another flight plan, this second Reference Waypoint would be named **TXKB**. If you create a Reference Waypoint using a waypoint with five characters in its identifier, the fifth character will be dropped (for example, **DUSTT** becomes **DUSTA**).

```

USE? INVRT? |
1:KDAL      |
2:BUJ       | ENTER REF
3:TXKA      | WPT:
4:KLIT      |
5:          |
-----
FPL 2 | ENR-LEG | CRSR

```

Figure 5-86

7. Press **■** once again to approve the waypoint page for the Reference Waypoint and insert it into the flight plan (figure 5-86).
8. Press the right **■** to turn off the right cursor function.

A Reference Waypoint is stored as a supplemental waypoint and counts as one of the 250 possible user-defined waypoints. Reference Waypoints that are part of a flight plan show up on the listing of user-defined waypoints displayed on the Other 3 (**OTH 3**) page. However, Reference Waypoints that are no longer part of a flight plan are deleted from the list of user-defined waypoints when the KLN 90B is turned off.

THIS PAGE INTENTIONALLY LEFT BLANK

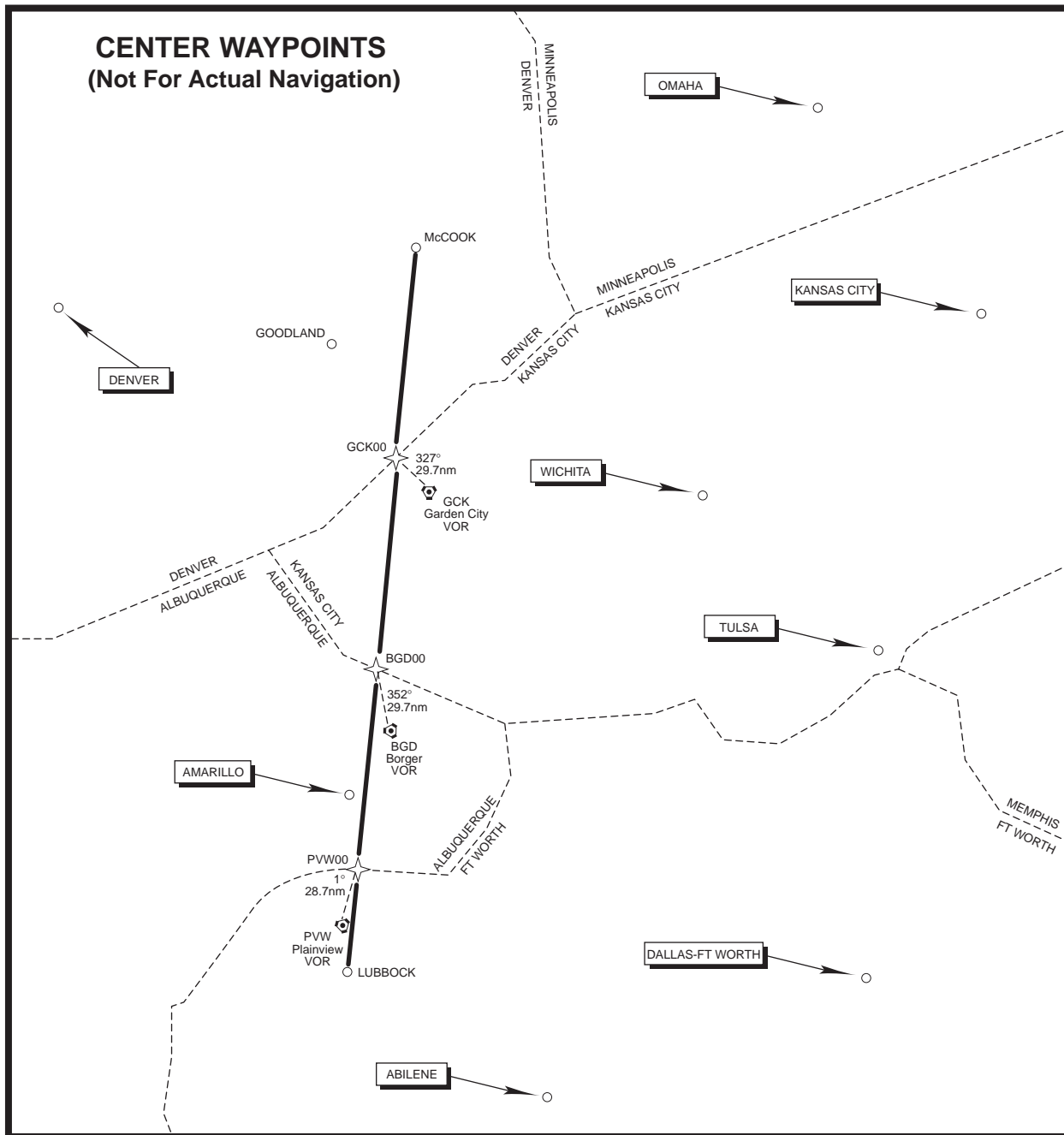

Figure 5-87

5.6 CENTER WAYPOINTS

Like Reference Waypoints, creating Center Waypoints is a method of adding waypoints to a flight plan. The word “Center” refers to air route traffic control center (ARTCC) or area control center (ACC). In some parts of the world these are referred to as “FIRs”. Center Waypoints are waypoints at locations where a flight plan intersects the “Center” boundaries. You may find Center waypoints useful when filing flight plans or complying with ATC requests to make sure that you have at least one waypoint in each Center’s airspace. Placing waypoints on the boundaries results in the minimum number of waypoints required to meet the criteria of having one waypoint in each Center’s airspace. The Center boundaries are stored in the database.

An example will illustrate the Center Waypoint feature. You are planning a flight from Lubbock, Texas International airport (**KLBB**) to McCook, Nebraska Municipal airport (**KMCK**) as shown in figure 5-87. A flight plan is initially created with just these two waypoints (figure 5-88). In order to give ATC more waypoints for your intended direct routing, you decide to utilize the Center Waypoint feature.

5.6.1 Creating Center Waypoints And Inserting Them in Flight Plans

To create the Center Waypoints:

1. Select the Center Waypoint 1 (CTR 1) page on the right side. If a flight plan page is not being displayed on the left side, the CTR 1 page will be as shown in figure 5-89.
2. Select the desired flight plan page on the left side. At this point it may be the active flight plan or one of the other 25 numbered flight plans (figure 5-90).
3. Press **ENT** to compute the Center waypoints. A Center Waypoint will be created at each intersection of the flight plan with a center boundary. When computation is complete, the CTR 1 page will display how many Center waypoints have been computed (figure 5-91).
4. If you wish to view the Center Waypoints before inserting them into the flight plan, turn the right inner knob to view the CTR 2 page(s). If there are multiple Center Waypoints, there will be an equal number of CTR+2 pages.

An example of a CTR 2 page is figure 5-92. The top line contains the identifier of the Center Waypoint. The KLN 90B automatically creates the identifier by appending the first available 2-digit number to the identifier of the nearest VOR to the waypoint. Thus, if Plainview

```

USE? INVRT? | DIS ETE
1:KLBB      | 396
2:KMCK
3:
-----
FPL 3 | ENR-LEG | D/T 1
    
```

Figure 5-88

```

PRESENT POS | DISPLAY
DBQ 274°FR  | DESIRED
      21.3NM | FPL ON
N 42°26.90' | LEFT PAGE
W 91°11.12'
-----
NAV 2 | ENR-LEG | CTR 1
    
```

Figure 5-89

```

USE? INVRT? |
1:KLBB      | PRESS ENT
2:KMCK      | TO COMPUTE
3:          | CTR WPTS
-----
FPL 3 | ENR-LEG | ENT | CTR 1
    
```

Figure 5-90

```

3 NEW WPTS
PRESS ENT
TO INSERT
INTO FPL
-----
CTR 1
    
```

Figure 5-91

```

PWV00 NEW
FW -ABQ CTR
PWV 001°
      28.7NM
N 34°33.21'
W101°40.01'
-----
CTR+2
    
```

Figure 5-92

(**PVW**) is the nearest VOR to the first Center Waypoint location, the **00** is appended to **PVW** to create **PVW00**. If **PVW** were later used in the creation of another Center Waypoint, the second waypoint's identifier would be **PVW01**.

The second line of the CTR 2 page shows the "from" Center followed by the "to" Center. In our example, **PVW00** lies on the boundary between Ft. Worth (**FW**) and Albuquerque (**ABQ**) Centers. See figure 5-87. A listing of the Center abbreviations is contained in Appendix D.

The third and fourth lines of the CTR 2 page display the Center Waypoint location in terms of the identifier of the nearest VOR to the Center Waypoint and the distance and radial from this VOR to the Center Waypoint. Lines five and six display the Center Waypoint location in terms of latitude and longitude.

5. Insert the Center Waypoints into the displayed flight plan by returning to the CTR 1 page on the right side and pressing **■** (figure 5-93). The Center Waypoints are inserted into the flight plan in the correct order.

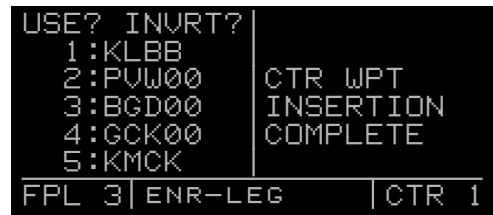

Figure 5-93

In the example above, the initial flight plan had just one leg; however, the Center Waypoint feature may be used with flight plans containing multiple legs as well. If inserting the Center Waypoints would cause the number of waypoints to exceed 30, then no Center Waypoints are displayed and the CTR 1 page will display the statement "**NOT ENOUGH ROOM IN FPL**".

5.6.2 Viewing the Center Waypoints After Insertion Into A Flight Plan

After the Center Waypoints have been inserted into a flight plan, you may go back and view the CTR 2 pages at any time. As long as you keep the same flight plan page displayed on the left side of the screen, you may view the Center Waypoints on the CTR 2 page(s) by merely displaying the CTR 2 page(s). However, the CTR 1 and CTR 2 pages revert to the format of figure 5-90 anytime you leave the specific flight plan page on the left side and then return to it. Under these circumstances you must press **■** to view the Center Waypoints on the CTR 2 page(s).

Center Waypoints are stored as part of the 250 user-defined waypoints and are considered supplemental waypoints. When Center Waypoints are viewed on the SUP page or on the Active Waypoint (ACT) pages, they appear in the normal supplemental waypoint format (figure 5-94). Center Waypoints that are part of a flight plan show up on the Other 3 (**OTH 3**) page. Center Waypoints that are no longer part of a flight plan are deleted from the list of user-defined waypoints when the KLN 90B is turned off.

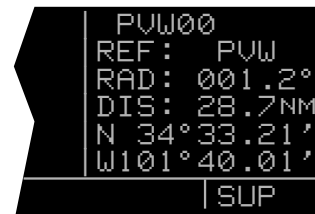

Figure 5-94

5.6.3 Creating Center Waypoints After Modifying A Flight Plan

Once Center Waypoints have been inserted into a flight plan, they are treated like any other waypoints in the flight plan. If a flight plan containing Center Waypoints is modified in any way, you may recompute new Center Waypoints. The original Center Waypoints are now part of the flight plan and new Center Waypoints are computed by treating the original Center Waypoints the same as any other waypoints in the flight plan.

If the interior of a flight plan containing Center Waypoints is modified, it may be desirable to manually delete obsolete Center Waypoints from the flight plan before computing new ones. However, if the flight plan is modified by adding new waypoints to the end of the flight plan, this may not be necessary. For example, let's say you decide to modify your existing flight plan from Lubbock to McCook by extending your flight to Omaha (figure 5-95). When you use the CTR 1 page to computer Center Waypoints, the CTR 1 page will now be as shown in figure 5-96. The newly computed Center Waypoint is identified as "NEW" on the CTR 2 page (figure 5-97) while the existing Center Waypoints no longer contain the "NEW" label.

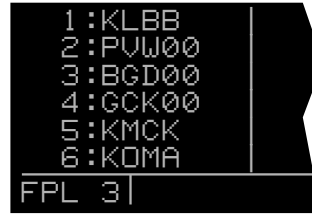

Figure 5-95



Figure 5-96

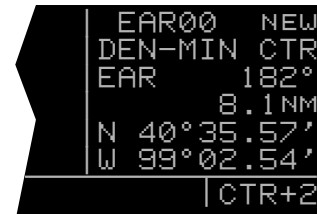

Figure 5-97

5.7 PROGRAMMING THE TURN-ON PAGE

You may personalize your KLN 90B by programming information on the Turn-On page. Up to four lines, each containing 23 characters, may be entered. The characters A through Z, the numbers 0 through 9, and spaces may be used. Once programmed, this information will be displayed for a few seconds each time you apply power to your KLN 90B. The example in figure 5-98 might give you some ideas, but use your imagination. How about programming the date your medical expires, or the date of your next biennial is due, or your wedding anniversary so that you'll be reminded each time you turn-on the unit? To program data on the Turn-On page:

1. Turn the KLN 90B off if it is on.
2. Turn on the unit. As soon as you see the Turn On page (figure 5-99, press the left **■**). You'll have to be ready because the Turn-On page is only displayed for a few seconds before automatically being replaced by the Self Test page (or the Take-Home page if the KLN 90B is being used in the take-home mode).
3. To program the first line (third line of display), use the left inner knob to select each desired character, and use the left outer knob to move the cursor. Spaces may be entered at the beginning of a line to center the text. If you make a mistake, you may move the cursor back to the desired location and re-enter the character. When the first line is complete, press **■**. The cursor will move to the second line.
4. Program the second, third, and fourth lines as you did the first line. Remember that you must press **■** to approve each line, including the last one.
5. If you wish to delete the text on a line you have already approved, use the left outer knob to position the cursor over the entire line. Enter a space for the first character in the line, and then press **■**.
6. When you are finished programming the Turn-On page, press the left **■**. Turn the unit off and back on - how does it look?



```
GPS                                ORS 20
©1994 ALLIEDSIGNAL INC
FRANKLIN SMITH
PILOT OWNER
N39296
SELF TEST IN PROGRESS
```

Figure 5-98



```
GPS                                ORS 20
©1994 ALLIEDSIGNAL INC
SELF TEST IN PROGRESS
```

Figure 5-99

5.8 THE STATUS PAGES

There are four Status pages. The Status 1 and Status 2 pages display information pertaining specifically to the GPS receiver while the Status 3 and Status 4 pages display supplementary information pertaining to the KLN 90B.

5.8.1 Determining The Status Of The GPS Signals

The Status 1 (**STA 1**) and Status 2 (**STA 2**) pages may be viewed at any time to determine the status of the GPS receiver and the GPS satellites being received. This includes which satellites are being tracked, the satellites' health, the signal-to-noise ratio for each of these satellites, the elevation of each satellite above the horizon, and the estimated position error.

The GPS receiver in the KLN 90B is capable of using signals from up to eight satellites to determine its position. A valid position may be determined using as few as four satellites alone or three satellites with an altitude input. However, four satellites alone or three satellites with an altitude input do not necessarily ensure that navigation can take place. The satellites must be positioned relative to your location such that sufficient "geometry" exists to determine an accurate position. The satellite constellation geometry is continually changing as each satellite rises, travels across the sky, and eventually sets relative to your position. The GPS satellites are not in geosynchronous orbits positioned over the same spot on earth at all times like some television communication satellites with which you may be familiar. Rather, the GPS satellites are in orbits that allow them to circle the earth about two times each day.

Figures 5-100 and 5-101 show a representative example of a set of STA 1 pages. There will be two STA 1 pages if more than four satellites are being received as in this example. The fact that there are two Status 1 pages is indicated in the page identification segment by the "+" in **STA+1**. The following information is displayed on a STA 1 page.

The GPS state is indicated on line 1:

INIT	initialization
ACQ	acquisition
TRAN	transition
NAV	navigation
NAV A	navigation with altitude aiding
NAV D	navigation with data collection
DEGRD	navigation with position degradation
FAILR	receiver failure

In the initialization state the GPS receiver is in the process of initializing itself, collecting information such as the date, time, and last present position. Next, the receiver collects data from its own memory to determine which satellites should be visible. After completing the

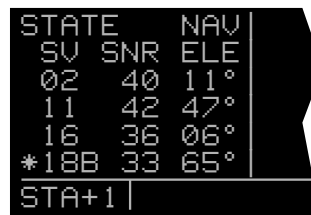

Figure 5-100

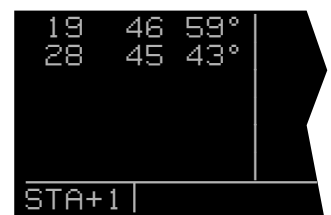

Figure 5-101

initialization process the receiver begins the acquisition process. During this time, the visible satellites are being acquired and data from them is obtained.

The transition state indicates an adequate number of satellites for navigation has been acquired and is being tracked but no position data can yet be produced.

Normal navigation is indicated by a **NAV**, **NAV A**, or **NAV D** GPS state. **NAV A** indicates that the altitude input is being used in the position solution. **NAV D** indicates that besides calculating position, the receiver is collecting and storing in its memory additional data information from the satellites (called ephemeris and almanac data).

- The specific GPS satellites or “space vehicles” (**SV**) being received are displayed in the left column. Each satellite has its own identification number. A * symbol to the left of the satellite number indicates this particular satellite is not presently being used in the navigation position solution.
- The satellite’s “health” is indicated to the right of the satellite number. This health information is transmitted by the satellites:

B	bad
W	weak
-	unknown
blank	good
- The signal-to-noise ratio (**SNR**) for each satellite being received is displayed in the middle column and indicates the signal strength for each satellite. The higher the SNR value the stronger the signal. Values usable for navigation will be in the mid 30s to mid 50s; however, typical values are in the middle of this range.
- The elevation (**ELE**) above the horizon for each satellite is provided in the right column and will range from 5° to 90°.

A representative Status 2 page is shown in figure 5-102. The STA 2 page displays the system’s estimate of the position error expressed in nautical miles. The KLN 90B’s position error depends upon such factors as the number of satellites being received, the strength of the GPS signals, and the geometry of the satellites presently being used for navigation.

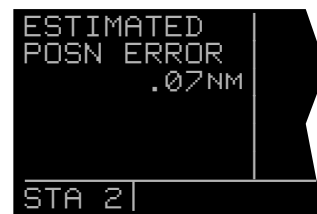

Figure 5-102

5.8.2 Determining KLN 90B Software Status And Operational Time

The Status 3 page (figure 5-103) displays the software revision status of the KLN 90B host computer and of the GPS receiver. A field called OBS CAL is also included on this page. This value indicates the calibration of the internal resolver circuitry of the KLN 90B. If for some reason your KLN 90B requires service, the information on this page may be useful.

The Status 4 page displays the KLN 90B's total operational time and also the number of times the unit has been turned on (figure 5-104). Kind of like having a built in Hobbs meter, isn't it! These values are set to zero if the KLN 90B's nonvolatile memory is cleared.

```
HOST SW  20
RCVR SW  20
OBS CAL  96
-----
STA 3|
```

Figure 5-103

```
TOTAL TIME
1364 HR
PWR CYCLES
581
-----
STA 4|
```

Figure 5-104

5.9 MODES OF OPERATION

The KLN 90B allows you to choose how the course to the active waypoint is defined. This is done by selecting between the two course modes, LEG and OBS. The LEG mode means that the course to the active waypoint is selected by the KLN 90B, and is the default mode when the KLN 90B starts up. The other course mode, OBS, is the mode that allows you to define the course to the active waypoint. This is the mode that you will use quite often if you conduct any non-precision approaches using the KLN 90B.

The KLN 90B also has three modes that are associated with approach operations. These are Enroute, Approach Arm and Approach Active. These modes will be explained in chapter 6.

The status of the course modes and the approach modes are annunciated in the lower center segment of the screen (figure 5-105). The exceptions to this are on the Turn-On page where the mode is not annunciated, and on the Super NAV 5 page where the mode is annunciated on the left side of the screen (figure 5-106). The following abbreviations are used for mode annunciation.

Mode	Annunciation
Enroute-Leg	ENR-LEG
Enroute-OBS	ENR:274
Approach Arm-Leg	ARM-LEG
Approach Arm-OBS	ARM:259
Approach Active-Leg	APR-LEG

The approach active-OBS mode is not a valid mode and cannot be selected.

For the OBS modes, the number included in the annunciation is the selected magnetic course. The course may be changed by several different methods which are described below.

5.9.1 Selecting The Leg Mode Or The OBS Mode

You will use one of two methods to change between course modes depending on how the KLN 90B is installed in your aircraft. In some installations, there will be some type of external switch and annunciators that will select the mode and indicate the status of the course modes. In other installations these switches will not be installed.

Use the following procedure to change to either the Leg mode or the OBS mode when no external course mode switch is installed:

1. Select the MOD type pages on the left side. The MOD page corresponding to the active mode will be displayed (figure 5-107).



Figure 5-105

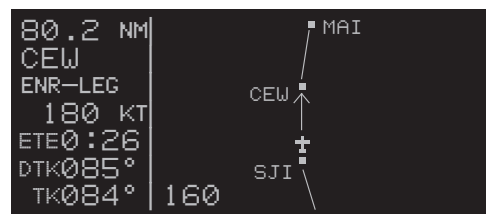

Figure 5-106

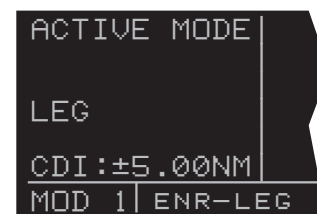



Figure 5-107

2. Rotate the left inner knob to select the MOD page for the desired mode: MOD 1 to select Leg or MOD 2 to select OBS (figure 5-108).
3. Press  (figure 5-109). The mode change is complete and you may return to any desired page.

It is not possible to change the mode by using the MOD pages when an external switch is installed. If you attempt to change the mode by using the MOD pages they will appear as shown in figure 5-110. Use the following procedure when an external LEG/OBS switch is installed in the aircraft:

1. Locate the external switch in the panel of the aircraft. An example of an external switch annunciator is shown in figure 5-111.
2. Change the position of the external switch. In the case of the combination switch/annunciator all that you have to do is press the unit and it will switch modes (figure 5-112).

5.9.2 The Leg Mode

The following are characteristics of the Leg Mode:

1. The default course deviation indicator (CDI) sensitivity is plus and minus five nautical miles, full scale. This applies to the CDI on the NAV 1 page as well as any external CDIs or HSI's interfaced to the KLN 90B. If the CDI or HSI has five dots left and right of the center position, then each dot represents one nautical mile of deviation.

NOTE: In some installations where the KLN 90B is interfaced to certain models of EFIS equipment, the scale factor will be plus or minus 7.5 nautical miles, full scale. Refer to the Flight Manual Supplement for the aircraft or the Pilot's Guide for the EFIS equipment for details.

2. Navigation is provided along the great circle path between two waypoints. As you probably know, great circle navigation is the shortest distance between two points located on the earth's surface. In the case of Direct To operation, the "from" waypoint is not displayed but it is the point where Direct To operation was initiated. The course to fly while in this mode is referred to as the desired track (**DTK**). The desired track is displayed on the NAV 3 and D/T 3 pages. You can also configure the Super NAV 5 page to display desired track, see section 3.9.7. To fly a great circle course between two points, the desired track may be constantly changing. A good way to illustrate this concept is with a world globe and a piece of string. You can determine the great circle path between Denver, Colorado and Manila, Philippines by stretching the string over the globe between these two points. Notice that you would start the flight with a Northwesterly desired track, which gradually becomes

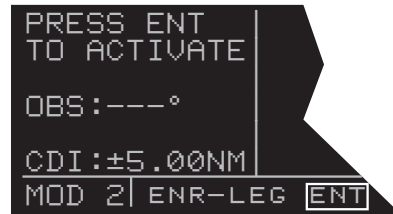

Figure 5-108

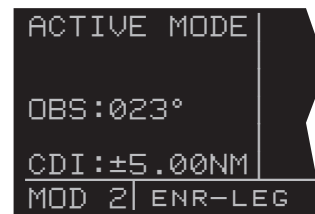

Figure 5-109

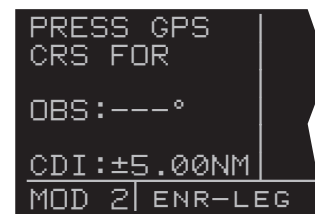

Figure 5-110

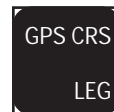

Figure 5-111

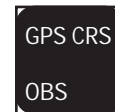

Figure 5-112

due Westerly, and finally Southwesterly by the time you reach Manila. Of course, your trips with the KLN 90B will be substantially shorter and the desired track will probably change only a few degrees.

3. Automatic waypoint sequencing is provided during flight plan operation. As you reach a waypoint in your flight plan, the next leg of the flight plan automatically becomes active. There are some situations during approach operations in which automatic sequencing is automatically disabled, see chapter 6.
4. Turn anticipation may be utilized in flight plan operation as described in section 4.2.2.
5. The Minimum Enroute Safe Altitude (**ESA**) displayed on the NAV 3 page is the highest MSA sector altitude from the present position to the destination waypoint along the active flight plan or Direct To route (whichever is in use). See section 3.9.4.

5.9.3 The OBS Mode

The following are characteristics of the OBS mode. Item 1 is the same as for the Leg mode.

1. The default course deviation indicator (CDI) sensitivity is plus and minus five nautical miles, full scale. This applies to the CDI on the NAV 1 page as well as any external CDIs or HSI's interfaced to the KLN 90B. If the CDI or HSI has five dots left and right of the center position, then each dot represents one nautical mile of deviation.

NOTE: *In some installations where the KLN 90B is interfaced to certain models of EFIS equipment, the scale factor will be plus or minus 7.5 nautical miles, full scale. Refer to the Flight Manual Supplement for the aircraft or the Pilot's Guide for the EFIS equipment for details.*

2. The course is defined by the active waypoint and the selected magnetic course. A course "to" or "from" the active waypoint may be selected.
3. The course selection is normally made by changing the selected course displayed on an external indicator such as an HSI, CDI or EFIS. When this is done, the pilot must verify that the proper course has been selected by confirming the digital selected course readout displayed on the KLN 90B. In the OBS mode the selected course is always displayed as part of the mode annunciation at the bottom center of the screen on all pages but the Super NAV 5 page. On the Super NAV 5 page, the mode/annunciation is displayed on the left side of the screen. In many installations, two or more navigation sources can be displayed on one indicator. In these situations there is a switch in the panel which will determine what navigation source is displayed. For the KLN 90B to properly read the external indicator the KLN 90B

must be the displayed navigation source on the external indicator.

When the KLN 90B is not the displayed navigation source on the external indicator or if the KLN 90B is interfaced with an EFIS system, it is possible to change the selected course from several pages on the KLN 90B. This can be done from the NAV 3 or Mode 2 (MOD 2) pages as well as the Super NAV 5 page if it is configured to display the desired track on the left hand side. To change the selected course from one of these pages:

- a. Select the NAV 3, MOD 2 or Super NAV 5 page (figure 5-113).
- b. Press the appropriate █ to turn on the cursor function. If the course is being changed from the Super NAV 5 page, use the left outer knob to rotate the cursor over the OBS angle field.
- c. Turn the appropriate inner knob to select the desired course (figure 5-114).
- d. Press the appropriate █ to turn off the cursor function.

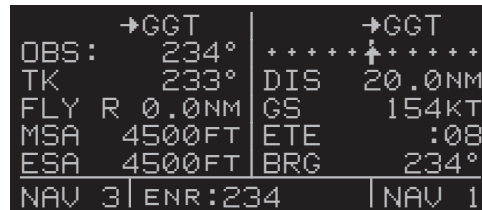

Figure 5-113



Figure 5-114

NOTE: It is easy to tell if it is possible to enter the OBS value on the KLN 90B. All that has to be done is to look next to the letters "OBS" displayed on either the MOD 2, NAV 3 or Super NAV 5 pages. If a colon (:) follows the letters OBS, then it is possible to enter a value from the KLN 90B. If the colon is missing, then the course must be changed from the external indicator.

NOTE: If the KLN 90B is interfaced to EFIS or if the KLN 90B is interfaced to certain mechanical indicators through an optional KA 90 adapter, the external indicator will be slewed to agree with what you entered on the KLN 90B.

4. There is no automatic leg sequencing or turn anticipation.
5. The Minimum Enroute Safe Altitude (ESA) displayed on the NAV 3 page is the highest MSA sector altitude from the present position to the active waypoint. See section 3.9.4. Other waypoints in the active flight plan do not affect the ESA.
6. When the active waypoint is a VOR or an approach waypoint, the published magnetic variation for the VOR or approach waypoint is utilized rather than the calculated magnetic variation.

5.9.4 Switching From The Leg Mode To The OBS

Mode

The following mode transition occurs if the KLN 90B is in the Leg mode and the mode is changed to the OBS mode:

1. The waypoint that was active in Leg mode prior to the mode change remains the active waypoint in OBS mode.
2. The selected course is defined by two different methods depending on the installation and the status of the unit.
 - i. If the KLN 90B is the displayed navigation source when the change is made to OBS mode, then the selected course becomes whatever was set on the external indicator prior to changing to the OBS mode. This value should normally be the desired track to the active waypoint if you had the external indicator set to the correct value prior to switching to the OBS mode.
 - ii. If the KLN 90B is interfaced with compatible EFIS systems, a compatible mechanical HSI interfaced through a KA 90 adapter, or if the KLN 90B is not displayed on the external indicator, then the selected course is chosen such that the deviation from the selected course remains the same.
3. If the OBS value chosen by default from rule 2 above is unacceptable, you can always define the desired course by the methods described in section 5.9.3.

5.9.5 Switching From The OBS Mode To The Leg

Mode

The following mode transition occurs if the KLN 90B is in the OBS mode and the mode is switched to the Leg mode:

1. The waypoint that was active while in the OBS mode remains the active waypoint when the Leg mode is activated. The system does not attempt to orient itself on a leg of the active flight plan unless the TO/FROM indicator is indicating FROM. In this case the KLN 90B will reorient on the active flight plan.
2. The selected course (**OBS**) that was active in the OBS mode prior to switching to a Leg mode becomes the desired track (**DTK**) in the Leg mode, unless the switch was made on the "from" side in which case the KLN 90B will calculate the correct desired track for the new leg.
3. With the exception of #2 above, the characteristics of normal Direct To operation apply.

5.9.6 Going Direct-To A Waypoint While in the OBS Mode

The direct-to function will select the OBS value that will take the aircraft from the present position direct to the active waypoint when the KLN 90B is interfaced to EFIS, a compatible mechanical HSI interfaced through a KA 90, or when the KLN 90B is not the displayed navigation source on the external indicator.

If the KLN 90B is the displayed navigation source on a non-driven HSI or a CDI it is not possible for the KLN 90B to change the OBS value. In these situations the KLN 90B will provide a scratch-pad message that will tell you what OBS value should be selected to go direct to the active waypoint (figure 5-115).



Figure 5-115

5.9.7 Activating A Waypoint While In The OBS Mode

While in the OBS mode, you may activate another waypoint by using the normal Direct To method or by using a second method. This second method activates another waypoint without changing the selected course (OBS). In other words, when the new waypoint is activated, the D-Bar is not recentered. In figure 5-116 the KLN 90B is in the OBS mode and the selected course is 90°. You have just crossed INITT intersection and desire to activate the next waypoint in the flight plan, FINAL, without recentering the D-Bar.



Figure 5-116

1. Press **[D]** (figure 5-117). The rules described in section 3.8, "DIRECT TO OPERATION", dictate which waypoint identifier will be initially displayed on the Direct To page.
2. Press **[D]** a second time. The annunciation **DIRECT TO** changes to **ACTIVATE** (figure 5-118). The right side still displays the appropriate waypoint page. Repeated presses of **[D]** alternates between **DIRECT TO** and **ACTIVATE**. Make sure **ACTIVATE** is displayed.
3. Press **[ENT]** to approve the waypoint page and activate the waypoint (figure 5-119). The selected course does not change, therefore this method does not center the D-Bar like a Direct To operation.



Figure 5-117



Figure 5-118

5.9.8 Changing the CDI Scale Factor

The CDI scale factor can be changed by using either the MOD 1 or MOD 2 pages. In normal operations it is possible to select a CDI scale factor which is plus or minus 5 NM, 1 NM or 0.3 NM full scale deflection. This means that if the scale factor was ±1 NM and the needle was deflected full scale to the right, the aircraft would be 1 NM left of course. The default CDI scale factor is ±5 NM.



Figure 5-119

If it is desired to change the CDI scale factor to another value, use the following procedure:

1. Select either the MOD 1 or MOD 2 page.
2. Press the left **■**. If necessary, use the left outer knob to move the cursor over the value of the CDI scale (figure 5-120).
3. Rotate the left inner knob to select the desired CDI scale factor (figure 5-121).
4. Turn the left **■** off. The CDI scale factor change is complete.

NOTE: The KLN 90B will automatically select a scale factor while in one of the approach modes. When the KLN 90B selects a CDI scale factor it is not possible to select a scale factor that is less sensitive than what the KLN 90B has automatically chosen. For example, as you will see in the next chapter, the approach-arm mode usually has a scale factor of ± 1 NM. While in the approach-arm mode it is not possible for you to select the ± 5 NM scale factor. This is to ensure proper operation of the approach modes.

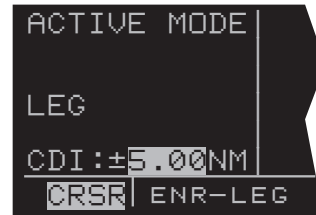

Figure 5-120

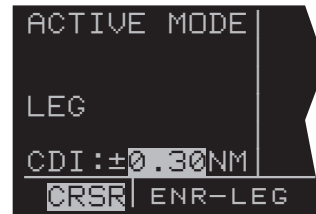

Figure 5-121

5.10 THE FUEL MANAGEMENT PAGES

Certain models of fuel management computers manufactured by Shadin Company, ARNAV System, Inc, and Sheltech Ltd. may be interfaced with the KLN 90B. The primary benefit of having the KLN 90B interfaced with a “real time” fuel management computer is that the system can continuously compute the amount of fuel required to reach the destination and the amount of fuel that will be on board upon reaching the destination. The concept is the following. The fuel management computer continuously sends the rate of fuel flow and the amount of fuel remaining to the KLN 90B. The KLN 90B continuously calculates the aircraft’s distance, ground-speed, and estimated time enroute (ETE) to the destination waypoint. The fuel required to reach the destination waypoint is the ETE multiplied by the current rate of fuel flow. The amount of fuel that will be remaining at the destination is the amount of fuel presently remaining minus the fuel required to reach the destination.

CAUTION: The KLN 90B fuel calculations are based on the present rate of fuel flow, the present ground-speed, the present distance to destination along the programmed route, and the amount of fuel presently remaining. Before take-off, the fuel flow computer must be properly initialized with the amount of fuel on board the aircraft. Since many factors influence the required amount of fuel to reach the destination, it is the pilot’s responsibility to view the fuel management pages often to check for any significant changes. Some factors affecting the amount of fuel required are power changes, altitude changes, headwind/tailwind component changes, fuel/air mixture adjustments, and routing changes.

The OTH 5, OTH 6, OTH 7, AND OTH 8 pages are used to display fuel management information for KLN 90B’s interfaced with compatible fuel management computers. If there is no fuel management computer interface, these fuel management pages are not displayed.

5.10.1 The Other 5 Page (OTH 5)

The OTH 5 page displays the following information (figure 5-122):

- The destination waypoint. An arrow is displayed to the left of the identifier if the waypoint is the active waypoint.
- The fuel units as received from the fuel management computer.

GAL	gallons
IMP	imperial gallons
L	liters
KG	Kilograms
LB	pounds

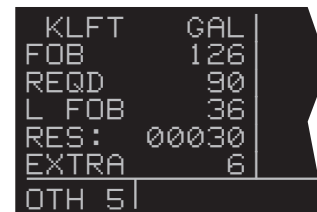



Figure 5-122

- The fuel presently on board (**FOB**). In most installations this is defined by using the fuel flow computer's control unit. However, if the KLN 90B is interfaced with a compatible Shadin fuel flow computer, it is possible to define the fuel on board by using the KLN 90B. In these installations it is not required to have the fuel flow computer's control head installed in the aircraft. To change the present fuel on board (FOB) use the following procedure:

1. Turn to the OTH 5 page.
2. If it is possible to enter the present fuel on board by using the KLN 90B there will be a colon (:) following FOB on the display. If the colon exists press the left  (figure 5-123), if the colon does not exist it is not possible to change the fuel on board through the KLN 90B (figure 5-122).

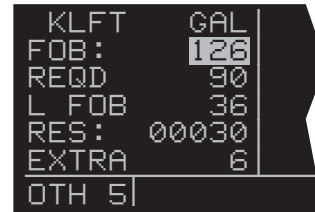

Figure 5-123

3. Enter the current fuel on board (FOB) using the left inner knob (figure 5-124). Make sure the amount entered is consistent with the units used by the fuel flow computer.

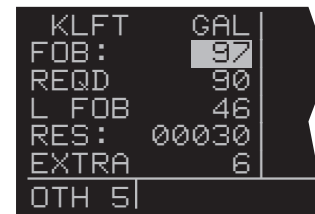





Figure 5-124

4. Turn the left  off.

- The fuel required to reach the destination waypoint at the current rate of fuel flow and the present groundspeed (**REQD**).
- The landing fuel on board (**L FOB**) is the fuel presently on board minus the fuel required to reach the destination.
- The desired fuel reserve (**RES**). You may enter here the amount of reserve fuel you wish to have upon landing. The fuel must be entered in the same units as displayed on the first line. To enter the reserve, press the left , rotate the left outer knob to move the cursor over each of the desired reserve digits, and use the left inner knob to select each digit. Press the left  when finished to turn off the left cursor function.
- The calculated extra fuel (**EXTRA**). This is the landing fuel on board (**L FOB**) minus the fuel reserve (**RES**) you entered.

5.10.2 The Other 6 Page (OTH 6)

The OTH 6 page displays the following information (figure 5-125):

- The endurance (**ENDUR**) in hours and minutes. The endurance is calculated based on the amount of fuel remaining after subtracting out the reserve (**RES**) you entered on the OTH 5 or the OTH 6 page from the present fuel on board.
- The range (**RANGE**), which is the distance (nautical miles) that could be flown based on the endurance calculated above and the present groundspeed.
- The fuel efficiency, which is the groundspeed divided by the present fuel flow.
- The desired fuel reserve (**RES**). Same as displayed on the OTH 5 page. Changing the reserve on one of the two pages also changes it on the other page.

FUEL DATA	
ENDUR	3:19
RANGE	597
NM/GAL	6.2
RES:	00030
OTH 6	

Figure 5-125

FUEL FLOW	
	GAL/HR
ENG 1	15
ENG 2	14
TOTAL	29
OTH 7	

Figure 5-126

FUEL FLOW	
	GAL/HR
	10
OTH 7	

Figure 5-127

FUEL USED	
	GAL
ENG 1	17
ENG 2	16
TOTAL	33
OTH 8	

Figure 5-128

5.10.3 The Other 7 Page (OTH 7)

The OTH 7 page displays rate of fuel flow. It has two formats depending on whether the aircraft is a twin engine (figure 5-126) or a single engine (figure 5-127).

5.10.4 The Other 8 Page (OTH 8)

The OTH 8 page displays the amount of fuel used. If interfaced with the ARNAV fuel management computer, this page displays dashes since the ARNAV system does not output fuel used. There are two formats for the page, depending on whether the aircraft is a twin engine (figure 5-128) or single engine (figure 5-129).

FUEL USED	
	GAL
	12
OTH 8	

Figure 5-129

5.11 THE AIR DATA PAGES

The Bendix/King KAD 280 and KAD 480 air data systems as well as specific models of Shadin Company air data systems may be interfaced to the KLN 90B. When interfaced with one of these systems, the KLN 90B will display real time air data parameters such as true airspeed (TAS), static air temperature (SAT), total air temperature (TAT), Mach number, density altitude, and pressure altitude. With a TAS input from an air data computer and a compatible heading input, the KLN 90B will calculate and display real time wind data (magnitude and direction).

NOTE: *Heading information inputs to the KLN 90B must be in a format which is different than available from most mechanical compass systems, including the Bendix/King KCS 55A (KI 525A with bootstrap heading synchro) and KCS 305 compass systems. However, the Bendix/King KA 90 adapter as well as the compatible Shadin air data system will convert three wire analog heading information from these mechanical systems into the proper format. Bendix/King electronic HSIs such as the EHI 40 and EHI 50 directly provide heading information to the KLN 90B.*

The Other 9 and Other 10 (**OTH 9** and **OTH 10**) pages are used to display air data information if both a fuel management system and an air data system are interfaced to the KLN 90B. If there is no fuel management system, air data information is displayed on the Other 5 and Other 6 pages. If there is no air data system interface, these pages are not displayed.

NOTE: *These air data pages receive inputs from air data sensors and display real time air data information. They are independent of the CAL 1, CAL 2, and CAL 3 pages which rely on manual pilot inputs to calculate air data information.*

5.11.1 The Other 9 Page (OTH 9)

Without a fuel management system this becomes the OTH 5 page. The following information is displayed (figure 5-130):

- TAS** True airspeed (the true speed of an aircraft through the surrounding air mass)
- MACH** Mach number (the ratio of the true airspeed to the speed of sound at a particular flight condition).

If a compatible source of heading information is provided to the KLN 90B, the following wind data is also displayed (figure 5-131):

- TLWND** Tailwind component of the wind
- HDWND** Headwind component of the wind
- WIND** The wind direction relative to true North and the wind speed

5.11.2 The Other 10 Page (OTH 10)

Without a fuel management system this become the OTH 6 page. The following information is displayed (figure 5-132):

- SAT** Static air temperature (the actual temperature of the surrounding air mass)
- TAT** Total air temperature (the air temperature including heat rise due to compressibility. This is the temperature measured directly by the OAT probe).
- PRS** Pressure altitude (to nearest 100 feet)
- DEN** Density altitude (to nearest 100 feet).

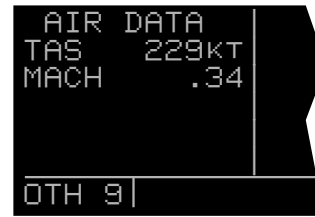

Figure 5-130

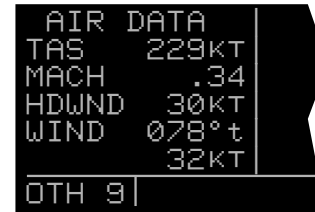

Figure 5-131

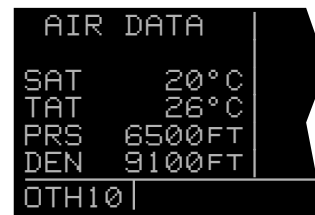

Figure 5-132

5.12 OPERATION OUTSIDE THE PRIMARY COVERAGE AREA

The KLN 90B's primary coverage area is from N 74° to S 60° latitude as was shown in figure 3-1. All navigation data presented outside this area is automatically referenced to true North unless a manual input of magnetic variation is made on the SET 2 page. The same is true anytime the KLN 90B is in the OBS mode and the active waypoint is outside the primary coverage area. Under both of these conditions, the following message will be displayed on the Message page:

**MAGNETIC VAR INVALID
ALL DATA REFERENCED
TO TRUE NORTH**

When navigation is within the primary coverage area, the SET 2 page does not display magnetic variation (figure 5-133). However, under the conditions stated above, a user entered magnetic variation may be made on line 6 of the SET 2 page using the left █ and left set of knobs (figure 5-134).

```

DATE/TIME
  30 MAY 92
14:59:28UTC
CORD UNIV/Z
SET 2|
    
```

Figure 5-133

```

DATE/TIME
  30 MAY 92
14:59:28UTC
CORD UNIV/Z
MAG V 10°W
SET 2|
    
```

Figure 5-134

5.13 OPERATION WITHOUT A DATABASE CARTRIDGE

The KLN 90B is designed so that a database cartridge is required for normal operation. However, in the event that the cartridge is inadvertently not inserted or that the cartridge fails, there is a reversionary mode providing partial operation that may be used.

NOTE: *Reversionary operation without a database cartridge should only be used for VFR flight, not for IFR.*

Without a database cartridge inserted, the Database page appears as in figure 5-135. All published waypoints (those that originated from the database cartridge) have been deleted from the active flight plan, FPL 0. Therefore, the only waypoints remaining in FPL 0 are any user-defined waypoints that were originally included in the flight plan.

```

NO DATA BASE
CARTRIDGE PRESENT
PUBLISHED WPTS HAVE
BEEN DELETED FROM FPL 0
MAGNETIC VARIATION:___°_
ACKNOWLEDGE?
| ENR-LEG | CRSR
    
```

Figure 5-135

The KLN 90B is unable to calculate magnetic variation without the database cartridge. Therefore, a magnetic variation must be manually inserted on the Database page when there is no cartridge. Use the right inner and outer knobs to enter the desired magnetic variation and press █ to enter (figure 5-136). With the cursor positioned over **ACKNOWLEDGE?**, press █ to approve the Database page. The magnetic variation can be entered on the Database page and on line 6 of the SET 2 page (figure 5-134).

```

NO DATA BASE
CARTRIDGE PRESENT
PUBLISHED WPTS HAVE
BEEN DELETED FROM FPL 0
MAGNETIC VARIATION:06°E
ACKNOWLEDGE?
| ENR-LEG | CRSR
    
```

Figure 5-136

The active flight plan is the only flight plan available when there is no database cartridge. There is no way to gain access to flight plans one through 25. Functions not requiring the published database are operative. Some functions, such as nearest airport, nearest VOR, nearest NDB, Reference Waypoint, and trip planning, are operational but only to the extent that user-defined waypoints are utilized. *Functions that depend on the database cartridge are not operative.* Some of these include Special Use Airspace, Minimum Safe Altitudes, ARTCC waypoints, FSS frequencies on the OTH 1 page, and ARTCC frequencies on the OTH 2 page. Non-precision approaches, SIDs and STARs are also disabled.

5.14 USING THE TAKE-HOME MODE

It is very likely that the KLN 90B will become your “best friend” in the cockpit. As with any good friend, you may need some time to get well-acquainted. This will allow you to utilize it to the maximum extent. A great way to get to know the KLN 90B is to use it outside the airplane, using what we call the “take-home mode”.

There are products available which allow you to use the KLN 90B at your home, office, or hotel to have get-acquainted time in the take-home mode, for instance the Commander 2000 from Lone Star Aviation. It is also helpful to do flight planning and perform database updates outside the airplane, perhaps with a home personal computer.

When the KLN 90B is in the take-home mode, it performs as if it is receiving adequate satellite signals to determine its position. It displays the latitude and longitude of its last known position or of whatever position it is initialized to on the Setup (SET 1) page (see section 3.6, “Initialization and Time to First Fix”). In addition, a ground speed and heading may be entered on the SET 1 page and the KLN 90B will track a flight plan or a direct to waypoint just as if it was actually functioning in an aircraft. Distances count down, waypoints sequence, and the deviation bar follows the progress of the simulated flight. Using the take-home mode is an excellent way to learn the operation of the KLN 90B without worrying about the engine running, other traffic, or even terrain (fortunately, these phenomena are not simulated in the take-home mode!)

CHAPTER 6 - LEVEL 4 OPERATION

This is the last chapter on the operation of the KLN 90B. In this chapter you will learn how to use the KLN 90B for non-precision approaches as well as SID/STAR procedures. All of these procedures require that you are com-

fortable with the operation of the unit as presented up to this point. In particular, you need to be comfortable with flight plan operation (chapter 4) and the OBS mode (section 5.9).

6.1 NON-PRECISION APPROACH OPERATIONS

Flying non-precision approaches using the KLN 90B are not in themselves very difficult. However, it is different than using traditional equipment such as VORs and NDBs. With this in mind, make sure that you practice with the KLN 90B in VFR weather with a check pilot before attempting to use the KLN 90B in actual IFR conditions.

CAUTION: *The KLN 90B obtains approach information from the database. Therefore, it is extremely important that the database is current. The KLN 90B is approved for IFR non-precision approaches only when the database is current. If you attempt to select an approach when the database is out of date, you will be given the status-line message: "OUTDATED DB" in the bottom center portion of the screen as a reminder.*

The following sections assume that your KLN 90B is properly installed in the aircraft with all of the necessary accessories to fly non-precision approaches. In most cases this will mean that the aircraft has external switch/annunciators to arm the approach mode and to select the LEG or OBS modes. An external annunciator to indicate when a message is active and when waypoint sequencing is about to occur will also be installed. In some installations the aircraft will have a NAV/GPS switch to select which navigation source is displayed on the primary HSI or CDI.

The Super NAV 5 page has been specifically designed to provide most of the functions needed for non-precision approaches. This page provides an interface that presents pertinent navigation information, a way to access the flight plan, and a graphic presentation of the present position relative to the flight plan waypoints. You will find this page to be a good friend while performing GPS based non-precision approaches.

NOTE: *There are some approach procedures in the world that are not suited for the operational characteristics of the KLN 90B. These procedures are not included in the database. Therefore it is not possible to use the KLN 90B for these approaches. It is good preflight practice ensure that the KLN 90B contains anticipated procedures for the flight.*

In addition to the two course modes (Leg and OBS) described in section 5.9, there are also two approach modes. These are approach arm and approach active. The status of the approach mode is indicated both on an external switch/annunciator and on the status line of the KLN 90B. In most installations the external annunciator will indicate **ARM** for the approach arm mode and approach active will be annunciated by **ACTV**. The main difference of these modes from the normal enroute mode is that the integrity monitoring is set to a tighter level. Another difference between these modes and the enroute mode is that the CDI scale factor will usually change to ± 1.0 NM for ARM and will always change to ± 0.3 NM when in the APR ACTV mode.

The ARM mode can be selected in two ways. The normal way is that this mode will be selected automatically by the KLN 90B when the aircraft is within 30 NM of an airport and an approach is loaded in the flight plan for that airport. It is possible to arm the approach mode at a distance greater than 30 NM from the airport by pressing the external GPS approach switch, but the KLN 90B will not change the CDI scale factor until the aircraft reaches the 30 NM point. If the GPS APR external switch is pressed while the approach mode is armed, then the KLN 90B will disarm the approach and change back to enroute mode. The CDI scale factor will also change back to ± 5.0 NM. The approach can be re-armed by simply pressing the GPS APR switch again.

The APR ACTV mode can only be engaged automatically by the KLN 90B. To cancel the APR ACTV mode press the external GPS APR switch. This will change the mode to APR ARM. Once past the FAF, it is not possible to return to the approach active mode without conducting a missed approach and flying back to the FAF.

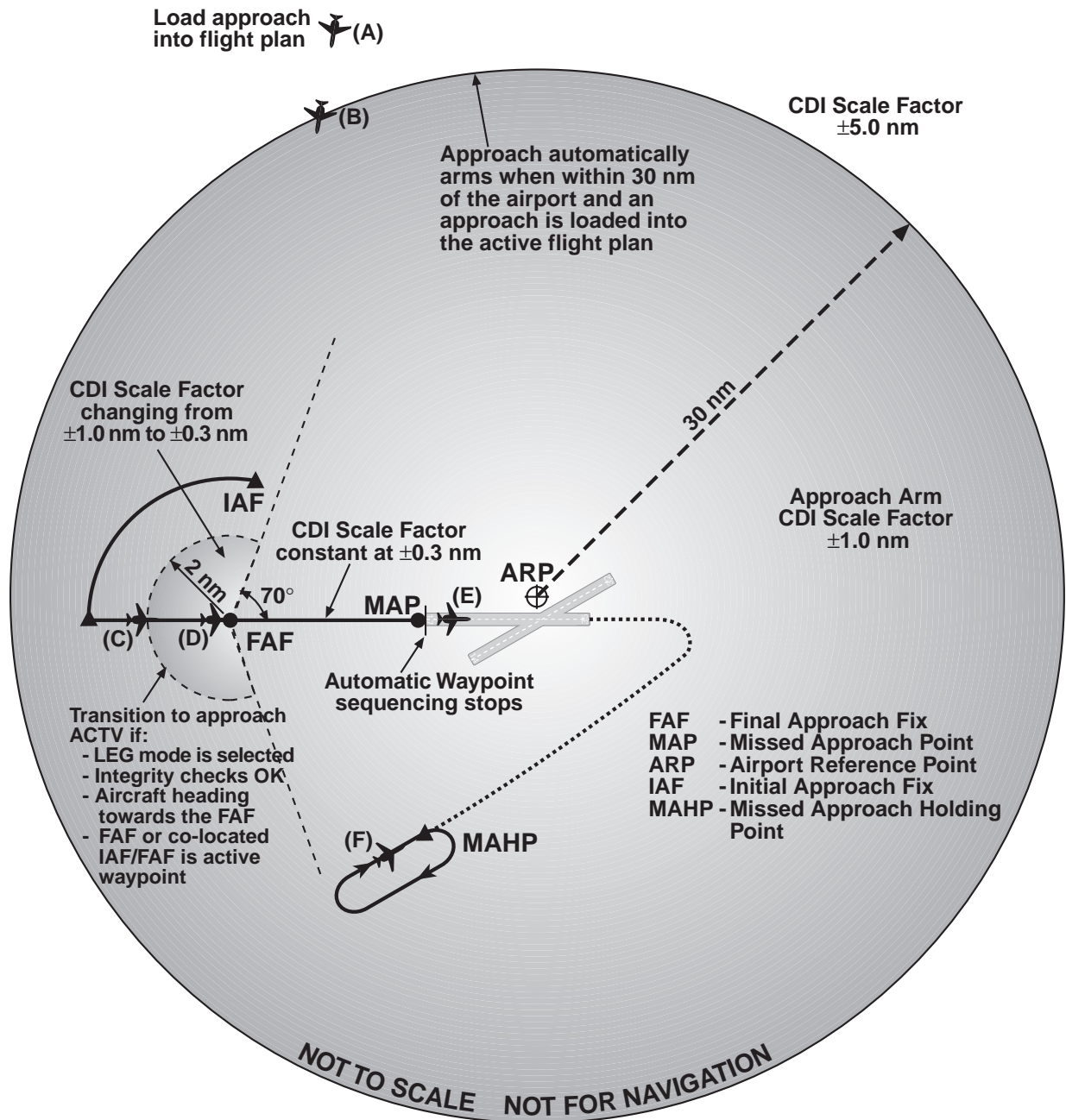

Figure 6-1 KLN 90B Approach Diagram

General Procedure for Non-Precision Approaches

Non-precision approaches will all have the general flow of events as follows. Refer to figure 6-1.

1. Select and load the approach into the flight plan.

This can be done at almost any time but must be completed before reaching the Final Approach Fix and should be done as soon as possible. This corresponds to point A in figure 6-1. If the aircraft is greater than 30 NM from the airport, then the CDI scale factor will remain at the default ± 5 NM full scale deflection.

2. Transition to the approach arm mode. This will occur automatically when the aircraft is within 30 NM of the airport and there is an approach loaded into the flight plan (position B in figure 6-1). The CDI scale factor will change to ± 1.0 NM over the next 30 seconds and the external annunciator will indicate **ARM**.

3. Get established on the final approach course.

- NoPT arrival route
- Radar vectors (requires OBS mode)
- Procedure turn or holding pattern (requires OBS mode)
- DME arc

4. Transition to the approach active mode. This mode change is automatic and occurs at position C in figure 6-1 when:

- the aircraft is 2 NM from the FAF and the approach mode is armed
- the LEG mode is selected
- the aircraft is heading towards the FAF
- the FAF or a co-located IAF/FAF is the active waypoint
- the KLN 90B confirms that adequate integrity monitoring is available to complete the approach.
- RAIM is available at FAF & MAP

If any of these conditions are not met, the KLN 90B will not transition to the approach active mode and a missed approach will be required if the conditions do not change before reaching the FAF. If all of these conditions are met then the CDI scale factor will start to change to ± 0.3 NM and the external annunciator will indicate **ACTV**.

5. At the FAF (position D in figure 6-1) the CDI scale factor will be at ± 0.3 NM and will remain at this scale factor until you manually cancel the approach mode by either pressing the external GPS APR button to change to the **ARM** mode, by initiating a direct to operation or by changing to OBS mode.

WARNING: It is not approved to conduct the final portion of the approach unless the KLN 90B is in the approach active mode (ACTV on external annunciator).

6. Fly to the Missed Approach Point. (position E in figure 6-1). The KLN 90B will not automatically sequence to the next waypoint. You must manually change to the appropriate waypoint according to the situation. By default, the KLN 90B will nominate the first waypoint of the published missed approach procedure when  is pressed and the active waypoint is the MAP (rule number 4 in section 3.8).

7. If necessary conduct the missed approach procedure. Remember to always refer to the paper chart when conducting a missed approach. The OBS mode is usually needed at some point during a missed approach and is always required to fly the holding pattern (position F in figure 6-1).

The details of the above operations as well as several examples of how to conduct non-precision approaches using the KLN 90B are given in the following sections.

6.1.1 Selecting An Approach

The first item in the list from the previous section is to select and load the approach into the active flight plan. Approaches are selected from the APT 8 (or ACT 8) page of the airport for which you desire to shoot the approach. If you are operating from a flight plan, the easiest way to get to the approach information is by turning to the ACT page for your destination as described in section 4.2.3.

The following example will use the VOR or GPS RWY 25R approach to Los Angeles International airport (KLAX).

1. Turn to one of the APT pages and select KLAX by using the right cursor, inner, and outer knobs (figure 6-2)

2. Use the right inner knob to turn to the APT 8 page. If you selected KLAX from the APT 1 page turn the inner knob one click counter-clockwise to reach the APT 8 page.

3. Turn the right cursor on by pressing the right **ENT**. The cursor comes up on the first approach in the list of approaches. Use the right outer knob to move the cursor to different approaches (figure 6-3). If there are more than 5 approaches to an airport you can move the cursor down to “scroll” the other procedures into view by rotating the right outer knob.

4. With the flashing cursor over “VOR 25R” press **ENT**.

5. The KLN 90B will present a list of Initial Approach Fixes (IAFs) corresponding to this approach. In this example we want the ELMOO IAF. Select this by pressing **ENT** when the cursor is over **ELMOO** (figure 6-4). Note: If there is only one IAF for a procedure, then the KLN 90B will skip this step and go on to the next step.

In many cases ATC will not tell you explicitly which IAF to use. In these cases you need to select an IAF which is closest to the route of flight that you expect. If you expect radar vectors, then the selection of the correct IAF is less important because you will be given vectors to the FAF and will not need to use the IAF.

6. The KLN 90B next presents a list of waypoints that make up the approach. Review these waypoints to make sure that you have selected the correct IAF. If there are more than four waypoints in the approach you can move the cursor up to “scroll” the other waypoints into view by rotating the right outer knob (figure 6-5).

7. If the cursor is over **LOAD IN FPL** (figure 6-6) and you press **ENT**, then KLN 90B checks to see if this airport is in the active flight plan. If it is not, the KLN 90B will ask if you want to add the approach and the airport reference point to the active flight plan (FPL 0). In most cases this is desirable, so press **ENT** (figure 6-7).



Figure 6-2



Figure 6-3



Figure 6-4

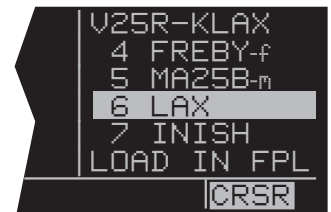

Figure 6-5



Figure 6-6

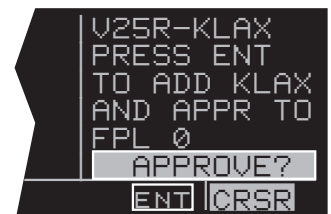



Figure 6-7

8. The KLN 90B will then bring up the FPL 0 page and put the sequence of approach waypoints in front of the airport reference point (figure 6-8).

NOTE: At any time during the process of selecting an approach you can easily return to the previous step by pressing the  button.

The waypoints that make up the approach procedure are loaded into the flight plan. At the top of the list of approach waypoints is a “header” that describes the approach that follows. The form of this header is ABBBB-CCCC. A is the first letter of the type of approach being flown (e.g. V for a VOR approach). BBBB will be filled in with the runway that the approach is to. Finally CCCC corresponds to the identifier of the airport which the approach is to. An example of this is shown in figure 6-8 where V25R-KLAX means the VOR 25R approach to KLAX.

After the approach has been entered into the flight plan the KLN 90B checks to make sure that the resulting flight plan “makes sense”. If the KLN 90B detects any waypoints that are in both the enroute portion of the flight plan and the portion that makes up the approach, then the following message will be given:

**REDUNDANT WPTS IN FPL
EDIT ENROUTE WPTS
AS NECESSARY**

Examine the flight plan and delete those enroute waypoints that are not necessary.

NOTE: Approaches can only be entered into FPL 0, the active flight plan. If the KLN 90B is turned off for more than 5 minutes, then the approach is deleted when power is turned back on.

6.1.2 Interpreting What You See

In the example above, you may have noticed a couple of waypoints with somewhat strange names. The second waypoint of the approach procedure, LAX18, has a name that is not normal for a waypoint. This is an example of what are called “terminal” waypoints. These are waypoints that are associated with a specific airport. They are used to define a spot on the ground that does not have a normal waypoint name. In the case of “LAX18” this point is 18 NM from the LAX VOR on the 68° radial. The fifth waypoint in the approach procedure, MA25B, is another type of terminal waypoint. In this case this point is the missed approach point for runway 25. This approach applies to both the left and right runways so the letter B is used to mean “both”.

There are few other types of terminal waypoints that you will need to be familiar with to fully understand GPS non-precision approaches. The naming convention for these waypoints are as follows:

V25R-KLAX	KLAX IAP
10 ELM00-i	1 NDB 24R
11 LAX18	2 VOR 07L
12 FITON	3 VOR 07R
13 FREBY-f	4 VOR 25L
17:KLAX	5 VOR 25R
FPL 0	ENR-LEG APT 8

Figure 6-8

- Fxyyy • F stands for Final Approach Fix
- lxyyy • l stands for Intermediate Fix
- Cxyyy • C stands for Course Fix
- Mxyyy • M stands for Missed Approach Point
- RWzzz • RW stands for Runway Fix. This is usually the MAP for the approach
- zzz will be a runway number possibly including L for Left, R for Right, C for Center, or B for Both.
- Daaab • D stands for DME arc waypoint
- aaa is the radial that the fix is on from the reference VOR
- b will be a letter corresponding to the distance from the reference VOR. For example, G is the seventh letter of the alphabet so D234G would be a point on the 234° radial 7 NM from the reference VOR. DME arcs greater than 26 NM will have waypoints where the first two characters are the first two letters of the DME identifier. The next three characters will be the radial that the arc waypoint is on.

In the rules above x and yyy are defined as follows. For runways with only one approach, x will be replaced with an “A” or a “F”. For runways that have multiple approaches, x will be replaced with “V” for VOR, “N” for NDB, or “R” for RNAV. The letters yyy will be replaced with either the runway identifier (e.g., FF25L) or, for circling approaches, the inbound course to the missed approach point (e.g., MA259).

Waypoints along a given radial will be named such that the first three letters are the reference VOR/DME and the next two are the DME distance. If the distance is greater than 100 NM the order is reversed. For example, LAX18 is 18 NM from LAX while 26FLW is 126 NM from FLW.

If the aircraft is not too far from the destination airport, the Super NAV 5 page can be used to determine where some of these waypoints are relative to others in the approach. At the time of this writing, all of the NOS charts and some Jeppesen charts do not show the special terminal waypoints that are required for GPS approaches. For this reason it is a good idea to understand what the special waypoints are used for and what they mean.

You may have also noticed that some waypoints have a dash and a small letter at the end of the waypoint name. The small letter is an aid that we have added to the name of some waypoints to help you recognize important points in the approach. These suffixes are displayed on the FPL 0 page, the Super NAV 5 page, and the Super NAV 1 page. The definitions of these suffixes are:

- i - The Initial Approach Fix (IAF) of the approach.
- f - This is the Final Approach Fix (FAF) of the approach

- m - The Missed Approach Point (MAP) of the approach
- h - The missed approach holding point for the approach

Every approach will have a FAF and a MAP. Almost all will have an IAF and missed approach holding point.

Another item that you should notice in the flight plan is the line that has ***NO WPT SEQ** on it (figure 6-9). This is what is referred to as a fence and the purpose of this line is to tell you that the KLN 90B will not automatically sequence past the waypoint that precedes the fence. The waypoint before the fence is always the missed approach point. The reason that waypoint sequencing is not allowed is that many missed approach procedures require specific actions before going to the missed approach holding point (e.g., climbing on a fixed heading until reaching an altitude).

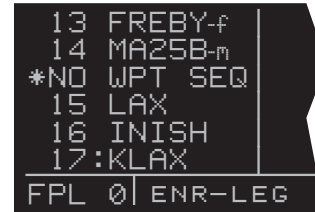

Figure 6-9

6.1.3 Changing Or Deleting An Approach Once Loaded Into The Flight Plan

The sequence of waypoints that are retrieved from the database of the KLN 90B define the approach procedures as they are charted. To ensure that the proper path over the ground is followed, it is not possible to either delete or add waypoints to the approach section of the flight plan. To help you see which waypoints are enroute waypoints and which are approach waypoints, the KLN 90B does not display a colon next to the waypoint number on the FPL 0 page if the waypoint is an approach waypoint.

It is only possible to replace the existing approach with another one, or delete the entire approach from the flight plan. To replace an existing approach, or delete an approach, follow these steps.

1. With the left page displaying the active flight plan (FPL 0) turn the left cursor on by pressing the left █ (figure 6-10).
2. Move the cursor so that it covers the approach header at the top of the approach procedure. Once the cursor comes over the approach header, it will automatically change to read **CHANGE APR?** (figure 6-11). If you press █ in this condition the KLN 90B will bring up the APT 8 page that corresponds to the current approach. At this point it is possible to select different approach procedures, different IAFs, or both.
3. If you press the █ button while the cursor is over the approach header it will change to read **DELETE APR?** (figure 6-12). If you press █ now, the KLN 90B will remove the entire approach procedure from the active flight plan. If the KLN 90B was in the approach arm or the approach active modes, then deleting the approach will cause the KLN 90B to change back to enroute mode. This means that the CDI scale factor will change back to the default ± 5.0 NM scale.



Figure 6-10

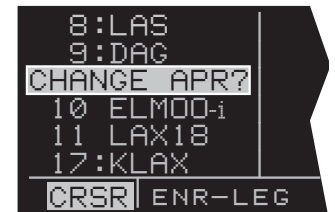

Figure 6-11



Figure 6-12

6.1.4 Example Approach: No Procedure Turn

Now that you know the basics of inserting an approach into the flight plan, we can now show the approach operation of the unit by several examples. This first example will use the approach that was loaded into the flight plan in section 6.1.1. This example will show how the KLN 90B sequences through an approach and what type of annunciations and scale factor changes can be expected. The KLN 90B will remain in the familiar Leg mode so there will be no need to change between Leg and OBS mode in this example. Refer to the approach plate for this approach (figure 6-13) to see what the procedure looks like.

For this example it is assumed that you are on an active flight plan with the final destination being the Los Angeles International airport, KLAX. It is also assumed that ATC will not give you radar vectors during this approach.

1. Load the VOR 25R approach to KLAX as demonstrated in section 6.1.1.
2. When you are within 30 NM of the airport, the KLN 90B will automatically arm the approach mode and provide the following message.

PRESS ALT TO SET BARO

The message acts as a reminder to make sure the KLN 90B is using the correct barometric pressure. If the barometric information is not correct, then the integrity monitoring provided by the KLN 90B will not be as good as it could be. Press **ALT** to bring up the ALT page and verify that the barometric pressure is correct.

NOTE: If the KLN 90B is interfaced with a compatible air data computer that provides the correct barometric pressure to the KLN 90B, then the previous message is not displayed and it is not necessary to update the barometric pressure.

At this time the KLN 90B will smoothly change the CDI scale factor to ±1.0 NM. The external approach annunciator installed in the aircraft will indicate that the approach is in the ARM mode.

3. As you approach ELMOO, the KLN 90B will provide waypoint alerting on the external annunciator as well as on the screen of the KLN 90B. Once you pass ELMOO, the KLN 90B will automatically sequence to the next waypoint in the approach, LAX18.

4. This may be a good time to select the Super NAV 5 page. This page is especially useful for getting a feeling of where you are in the approach (figure 6-14).

5. As the aircraft approaches the LAX18 waypoint, the KLN 90B will again provide waypoint alerting. As the aircraft passes LAX18 and sequences to FITON, the KLN

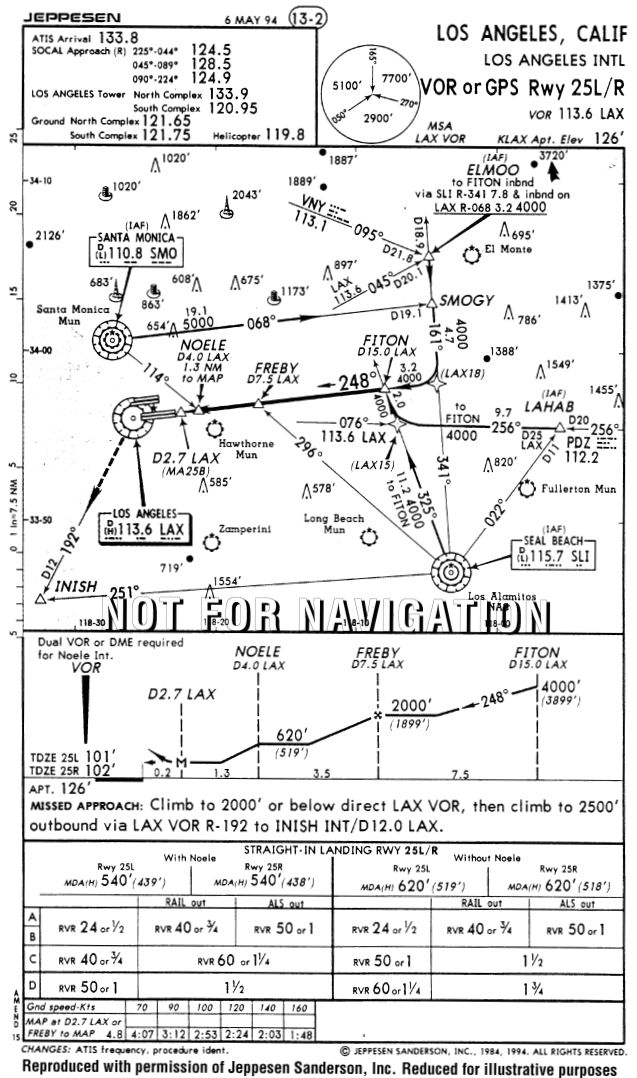

Figure 6-13

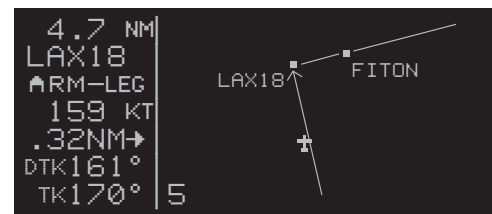

Figure 6-14

90B will provide a message telling you to set the external indicator (CDI or HSI) to a new value. If desired track (DTK) is shown on the screen, this value will flash when the external selected course does not match the DTK within 10°.

NOTE: If the KLN 90B is interfaced to EFIS or a suitable mechanical HSI through the optional KA 90 adapter, then the external course pointer will be driven to the correct value when leg sequencing occurs.

6. As the aircraft approaches the FAF (FREBY) it is a good idea to check over the status of the KLN 90B. Look at the external indicators to verify that LEG sequencing is selected. Remember, the KLN 90B will not transition to the approach active mode if the OBS mode is selected. If the KLN 90B shares an HSI or CDI with other NAV sources, it is also good to verify that the NAV/GPS switch is set to GPS.

7. By the time the aircraft is 2 NM from FREBY, the Final Approach Fix, the KLN 90B will make a prediction to see if integrity will be available at the FAF and at the MAP. If the prediction indicates that integrity monitoring will be available, and RAIM is currently available, the KLN 90B will change the GPS APR annunciator to read ACTV and the status line will indicate APR (figure 6-15). At this time the KLN 90B will also start to change the CDI scale factor. By the time the aircraft reaches the FAF (FREBY) the CDI scale factor will be down to ±0.3 NM.

8. The fix NOELE is not included in the list of waypoints provided in the database. You will need to identify this point by using the along track distances given in the profile view of the approach plate. In this example NOELE is located 1.3 NM from the MAP. When the distance to MA25B is 1.3 NM, then the aircraft is at NOELE and you can descend to the MDA for this approach.

NOTE: Some approach procedures require that you add up several along-track distances to be able to identify a step down fix.

9. The KLN 90B will again provide waypoint alerting as you approach MA25B. This is shown on the Super NAV 5 page by a flashing active waypoint identifier. If the AUTO scale factor was chosen for the Super NAV 5 page then the airport diagram will be visible when the aircraft is within 5 NM of the airport. More detail is shown as the aircraft gets to within 1 NM of the airport (figure 6-16).

The following steps would need to be performed if a missed approach is required.

11. Upon reaching MA25B and not seeing the runway you decide to perform a missed approach. Remember, the KLN 90B will not automatically sequence past the missed approach point. This is shown on the Super NAV 5 page by not showing any lines connecting waypoints

that are past the MAP. To perform the published missed approach procedure, press **■** to bring up the direct-to page. The default waypoint will be the first waypoint of the missed approach procedure. In this case the first waypoint is LAX. Confirm this waypoint as the direct to waypoint and press **■**.

12. Upon reaching LAX, the KLN 90B will sequence to the next waypoint in the missed approach procedure, INISH. In this example, there is no holding pattern published for the missed approach so you can expect further instructions upon reaching INISH.

NOTE: If ATC gives you instructions for a missed approach that is different from the published missed approach procedure, it is always possible for you to select a different direct to waypoint than the default direct to waypoint.



Figure 6-15



Figure 6-16

6.1.5 Example Approach: Off-Airport Navaid

An approach that is quite common is an approach that is based off of an off-airport navaid. An example of this is the VOR RWY 22 approach to Clovis New Mexico Municipal airport, KCVN. To fly this procedure as published use the following steps and refer to figure 6-17 for the procedure. For this example assume that the aircraft is approaching from the Northeast going Direct-to the Clovis airport with no active flight plan.

1. Load the approach into the flight plan as described in section 6.1.1. In this case there is only one IAF so the KLN 90B does not present the option for you to select an IAF. In this example, there is no active flight plan to begin with so the KLN 90B will ask to add the airport and the approach to FPL 0 (figure 6-18).

2. Approaching the area ATC tells you to go direct-to the TXO VOR and clears you for the approach to KCVN. This is easy to do from the Super NAV 5 page by pulling out on the right inner knob and scanning through the active flight plan by turning the inner knob. Once TXO is displayed in the scanning window (figure 6-19), press [] and then [] to initiate a direct to operation to the TXO VOR.

3. At a distance of 4 NM to the TXO VOR, the KLN 90B will give the following message:

IF REQUIRED SELECT OBS

This message provides a reminder that to fly a course reversal the OBS mode needs to be selected. Note from the approach chart that there is a NoPT Arrival Sector for this approach. If you are approaching TXO within the indicated area there is no need to perform a course reversal and you need to ignore this message. The NoPT sector is not stored in the database so it is not possible for the KLN 90B to know if a course reversal is required or not; as a result, the KLN 90B will always give this message whenever a waypoint could be used for a course reversal. The KLN 90B will properly sequence to the FAF to MAP leg and transition to the approach mode when 2 NM from the IAF/FAF.

If however, you are approaching from any other direction a course reversal is required and the OBS mode will need to be selected. If the OBS mode is not selected before reaching TXO, then the KLN 90B will automatically sequence to the missed approach point. This is not desirable when performing a course reversal so the OBS mode must be selected before reaching TXO.

NOTE: The KLN 90B will only remind you to select OBS mode if the IAF is the active waypoint. Therefore if a course reversal is required, make sure the IAF is the selected waypoint.

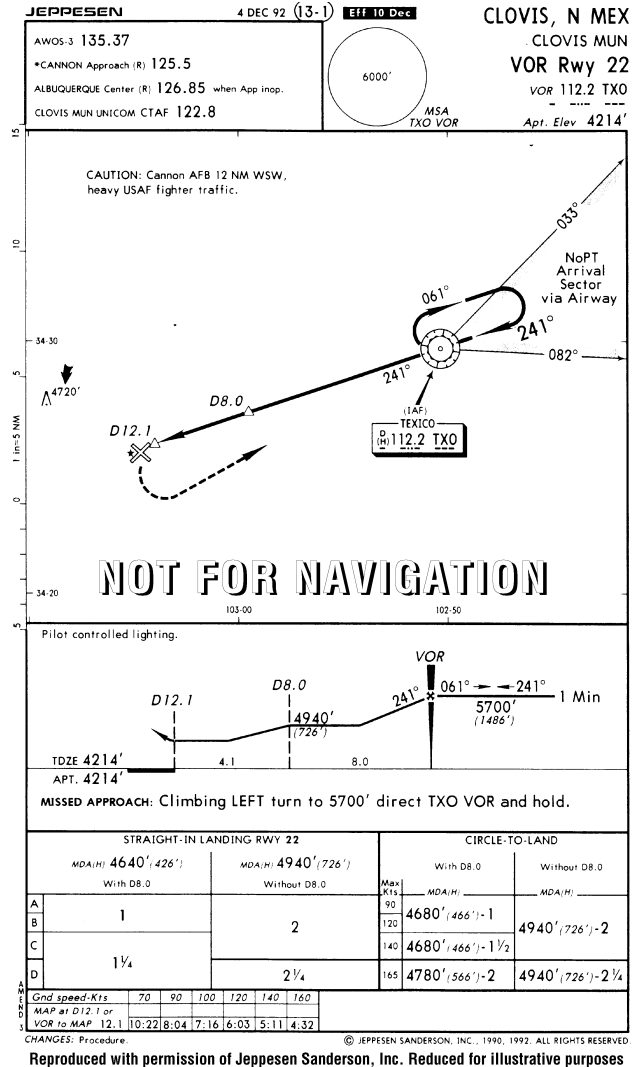

Figure 6-17

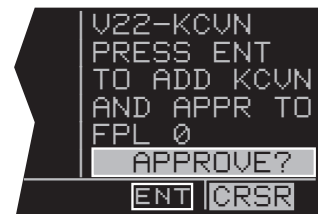

Figure 6-18

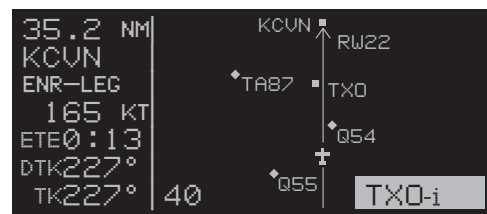

Figure 6-19

4. If a course reversal is required, then upon reaching TXO perform the appropriate holding pattern entry and set the inbound course on the external CDI or HSI. In this example the inbound course is 241°. At this point the KLN 90B works very similar to a conventional VOR/DME.

5. Once established on the inbound course of 241°, switch back to the Leg mode. When Leg mode is selected the FAF is automatically made the active waypoint when the IAF and the FAF are at the same waypoint.

NOTE: It is mandatory that the unit be in LEG mode with the FAF as the active waypoint before crossing the FAF to activate the approach active mode and change to ± 0.3 NM scale factor. The CDI scale factor changes from ± 1.0 NM to ± 0.3 NM over the two miles to the FAF. Delaying the switch from OBS to Leg mode compresses the scale factor change. This will make the transition more abrupt. If the switch from OBS to Leg is delayed too long it will not be possible for the KLN 90B to change to the approach active mode.

6. When the aircraft is 2 NM from the FAF, the KLN 90B will verify that the proper integrity is available. If integrity monitoring is available for the approach, then the KLN 90B will change to the Approach Active mode. This will be annunciated on the external approach status annunciator as well as on the KLN 90B. The CDI scale factor will also start to change from ± 1.0 NM to ± 0.3 NM.

7. Upon reaching TXO, the KLN 90B will automatically sequence to RW22, the missed approach point.

8. The fix at 8 DME from TXO along the final approach course is not included in the waypoints that come from the database. Since the distance that the KLN 90B is giving you is distance TO the MAP, you will need to mentally figure out when the aircraft has reached this point. This is done by looking at the along track distances given in the plan view of the approach. In this case the fix is 4.1 NM from RW22. Upon reaching this distance you can descend to the MDA for this approach.

If a missed approach is required for this approach, then the following steps would be required.

9. The published missed approach procedure for this approach is to make a climbing left turn to 5700 feet and proceed direct to the TXO VOR. In this case TXO will be the default direct to waypoint when **■** is pressed. This is the desired waypoint so press **■** to confirm the waypoint and proceed direct to the VOR.

NOTE: If ATC gives you instructions for a missed approach that is different from the published missed approach procedure, it is always possible for you to select a different direct to waypoint than the default direct to waypoint.

10. As the aircraft approaches TXO you will need to select OBS mode to stop waypoint sequencing and define the inbound course for the holding pattern. If you do not select the OBS mode before the aircraft is within 4 NM of the holding point, then the KLN 90B presents a message reminding you to select the OBS mode.

NOTE: If another attempt at the approach is desired after holding, it is necessary to manually change the active waypoint. When the FAF and the missed approach holding point are at the same place then the KLN 90B will automatically change the active waypoint to the FAF when you change from OBS to LEG. Make sure to make this change as soon as possible to ensure the approach active mode becomes the active mode.

6.1.6 Example Approach: Radar Vectors

For this example we will use the same approach that was used in the previous section except this approach will be conducted with the help of radar vectors from approach control. The aircraft will be assumed to be arriving from the West, although this does not change the way the approach will be flown using the KLN 90B.

1. The approach has been selected and entered into the flight plan and the aircraft is going direct to KCVN (Clovis, New Mexico Municipal) as described in section 6.1.5.
2. As soon as ATC mentions radar vectors you should immediately start to think of the OBS mode. Once given radar vectors, change the active waypoint to TXO and select the OBS mode. Note that it is not important what order these events take place. It is just as effective to change to OBS mode and then change the active waypoint as it is to change the active waypoint and then switch to OBS mode.
3. Next, change the selected course on the CDI or HSI to the final approach course. For this example, the inbound course is 241°. It is now possible to watch your progress on the Super NAV 5 page and anticipate when you will be given new headings to fly (figure 6-20).
4. Once established on the inbound course, you will need to change back to the Leg mode to allow for proper approach operation and automatic leg sequencing. For best performance, the change back to Leg mode should be made before the aircraft is 2 NM from the FAF.

NOTE: It is mandatory that the unit be in LEG mode with the FAF as the active waypoint before crossing the FAF to activate the approach active mode and change to ± 0.3 NM scale factor. The CDI scale factor changes from ± 1.0 NM to ± 0.3 NM over the two miles to the FAF. Delaying the switch from OBS to Leg mode compresses the scale factor change. This will make the transition more abrupt. If the switch from OBS to Leg is delayed too long it will not be possible for the KLN 90B to change to the approach active mode.

5. The rest of this approach would be flown using the same steps as presented in section 6.1.5.



Figure 6-20

THIS PAGE INTENTIONALLY LEFT BLANK

6.1.7 Example Approach: On-Airport Navaid

Another common type of approach is an approach that is based on an on-airport navaid. These could be either VOR or NDB approaches. An example of this type of approach is the VOR RWY 24 approach to Bowman airport in Louisville, Kentucky (Figure 6-21). The airport identifier for this airport is KLOU.

For this example assume that the aircraft is approaching KLOU from the Nabb VOR.

1. After passing the Nabb VOR, you are told to expect the VOR 24 approach at KLOU. You load the approach using the procedure described in section 6.1.1.

2. When the distance from the present position to the destination airport reaches 30 NM, the KLN 90B will automatically arm the approach mode. The CDI scale factor will transition to ±1.0 NM and the KLN 90B will provide more sensitive integrity monitoring. You also press █ to update the barometric information.

3. When the aircraft is 4 NM from the BQM VOR, the KLN 90B will give a message reminding you to select the OBS mode. The OBS mode is required for the procedure turn. In this case, don't select the OBS mode until after the KLN 90B has sequenced past BQM-i and made FF24-f the active waypoint. (This will keep you from having to manually activate FF24-f while in the OBS mode.) After passing BQM, select the outbound course of 068° on the external CDI or HSI.

4. With the OBS mode selected and FF24 as the active waypoint, it is possible to fly the procedure turn. Allow enough distance past FF24 to complete the procedure turn and still be 2 NM away before reaching the FAF. After completing the heading portion of the procedure turn, change the selected course to the inbound course of 248° on the external CDI or HSI.

5. Once established on the inbound course the Leg mode will again need to be selected so that proper approach operation and waypoint sequencing will occur.

NOTE: It is mandatory that the unit be in LEG mode with the FAF as the active waypoint before crossing the FAF to activate the approach active mode and change to ±0.3 NM scale factor. The CDI scale factor changes from ±1.0 NM to ±0.3 NM over the two miles to the FAF. Delaying the switch from OBS to Leg mode compresses the scale factor change. This makes the transition more abrupt. If the switch from OBS to Leg is delayed too long it will not be possible for the KLN 90B to change to the approach active mode.

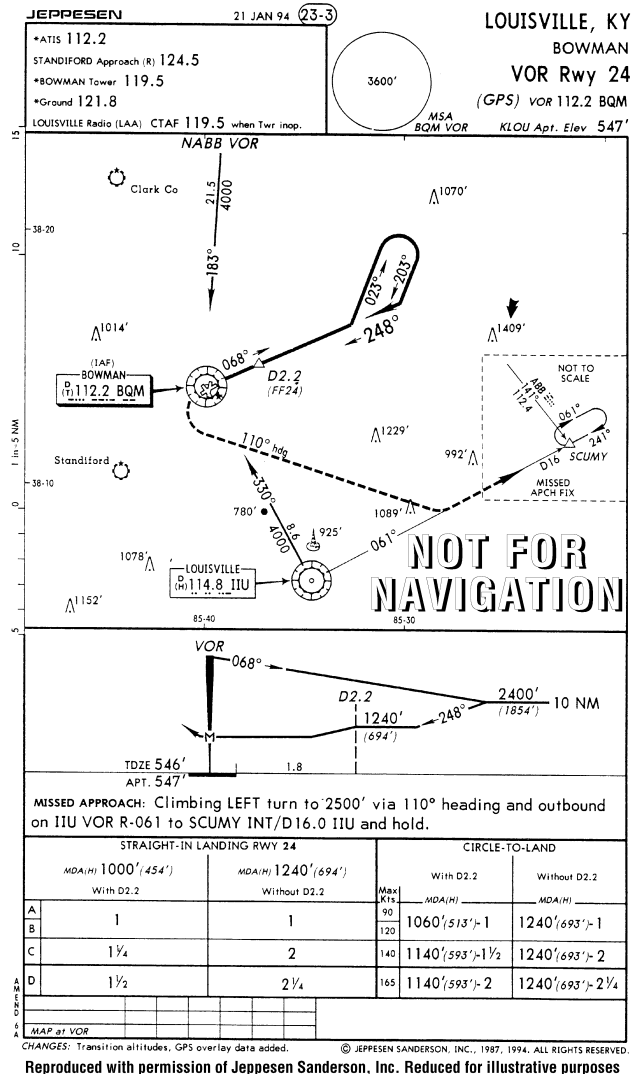

Figure 6-21

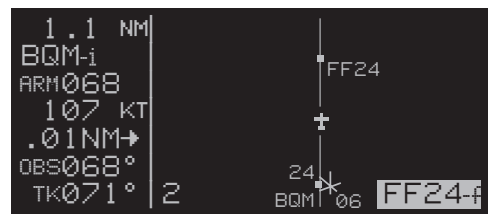

Figure 6-22

6. When the aircraft is 2 NM from the FAF, the KLN 90B will verify that the proper GPS integrity is available. If integrity monitoring is available for the approach, then the KLN 90B will change to the Approach Active mode. This will be annunciated on the external approach status annunciator as well as on the KLN 90B. The CDI scale factor will also start to change from ± 1.0 NM to ± 0.3 NM.

7. Normal waypoint alerting will occur as the aircraft passes the final approach fix. The leg from the final approach fix to the missed approach point will become active and the CDI scale factor will remain at ± 0.3 NM. If the AUTO scale factor was selected on the Super NAV 5 page, then the scale factor will zoom in on the airport as the aircraft gets closer and closer to the missed approach point. Eventually the map scale changes to 1 NM and the runway diagram becomes visible on the map.

The following steps are followed if a missed approach is required.

8. The missed approach instructions call for a climbing left turn to a heading of 110° until intercepting the 061° inbound course to the missed approach holding fix, SCUMY. To fly this with the KLN 90B it will be necessary to put the KLN 90B into the OBS mode and make SCUMY the active waypoint. Change the selected course on the external CDI or HSI to 061° .

9. Once the aircraft reaches SCUMY, you will need to perform a holding pattern entry suitable for this holding pattern and set the selected course to 241° for the holding pattern.

6.1.8 Example Approach: DME Arc

DME arc procedures with the KLN 90B are completely different from using traditional VOR and DME equipment. Don't worry though because DME arc procedures using the KLN 90B are also easier than using traditional equipment. This is because the KLN 90B provides left/right guidance around the arc. No more having to watch distance in one place and radial in another!

A DME arc is really a whole bunch of initial approach fixes placed one next to each other to form an arc. Very rarely do you actually fly to the beginning of an arc. Instead, the flight path of the aircraft generally intersects the arc at some point. Once the aircraft is near the arc, it is then possible to turn so that the arc distance is maintained until time to turn to the inbound fix.

The following example will show how DME arc procedures are flown using the KLN 90B. This example approach will be to use the VOR RWY 12 approach to Owatonna, Minnesota, KOWA. The approach plate for this approach is in figure 6-23. Assume that the aircraft is approaching from the North.

1. ATC assigns the VOR RWY 12 approach. Turn to the APT 8 page for KOWA to select the approach. You select the VOR 12 approach and the KLN 90B presents the IAF selection page (figure 6-24).

2. There are five choices for the IAF. Three of these choices you can recognize but the other two, D040L and D220L, are unfamiliar and not shown on this chart. These two waypoints are the database identifiers for the ends of the arc. D040L means **D**ME arc point, **040** is the radial which the waypoint lies, and **L** indicates the distance of the arc. **L** is the twelfth letter of the alphabet so the L indicates that this is a 12 DME arc. In a similar manner D220L can also be decoded. In this example the aircraft is approaching from the north so the D040L IAF will be selected.

3. The KLN 90B knows that this point is associated with a DME arc. Once an arc waypoint is chosen, the KLN 90B determines what radial of the reference VOR the aircraft is presently located on. A waypoint is created that is located at the intersection of the present radial and the DME arc. This waypoint is the first waypoint in the list of waypoints presented on the APT 8 page before loading the approach into the flight plan (figure 6-25). This waypoint is named using the same convention discussed earlier.

NOTE: If the present radial from the reference VOR is outside of the defined arc, then the KLN 90B will default to the beginning of the arc.

CAUTION: The KLN 90B does not take into account the geometry of the active flight plan when determining the arc intercept point. This point is defined

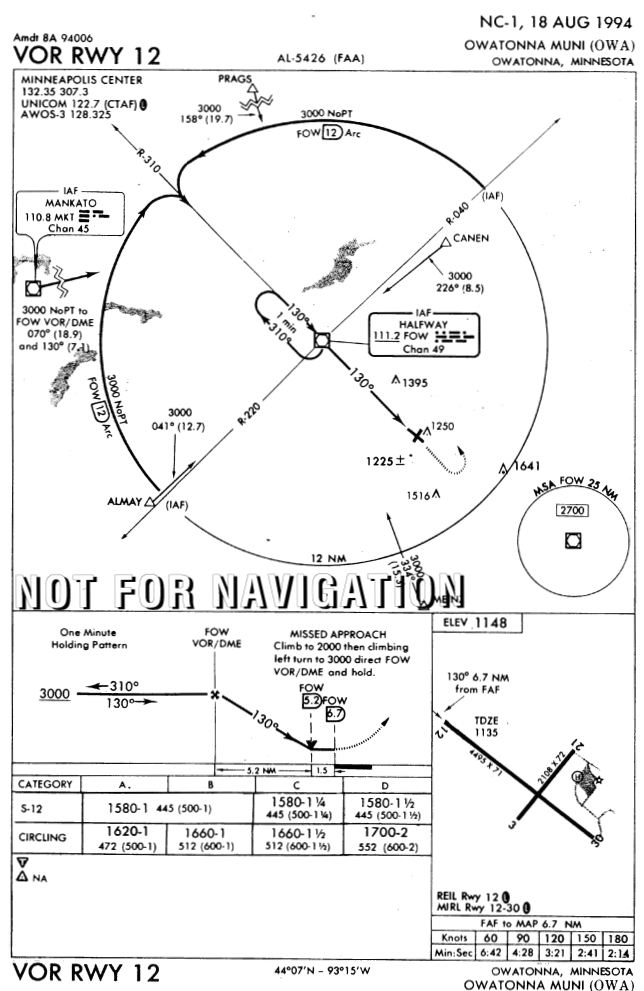

Figure 6-23

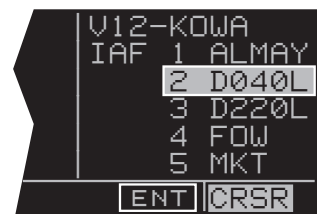

Figure 6-24

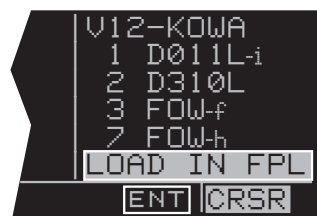

Figure 6-25

solely on the present radial and the defined arc distance from the reference VOR. For this reason it is better to delay selecting approaches that contain DME arcs until the aircraft is closer to the destination.

4. With the cursor over **LOAD IN FPL**, press **■**. The approach will be loaded into the active flight plan just like any other approach would be.

5. After the approach is loaded into the flight plan the KLN 90B may give the message:

**REDUNDANT WPTS IN FPL
EDIT ENROUTE WPTS
AS NECESSARY**

Examine the flight plan and, if practical, observe the Super NAV 5 page to make sure that the sequence of waypoints does not have any unnecessary legs in it.

6. The KLN 90B will now provide guidance to the arc intercept point. The Super NAV 5 page displays the entire arc on the screen. The portion that is between the beginning of the arc and the arc intercept is drawn with a dashed line. The part that is between the arc intercept point and the end of the arc is drawn with the normal solid line (figure 6-26).

7. In some cases ATC may provide radar vectors to the arc. The KLN 90B provides a means to define a new intercept point based on the current track of the aircraft over the ground. This can be done from either the Super NAV 5 page or from the FPL 0 page. The dashed line displayed on the Super NAV 5 page will help you to determine if ATC is giving you correct vectors.

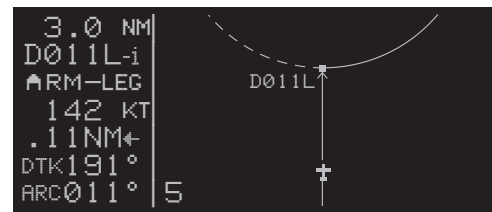

Figure 6-26

- From the Super NAV 5 page, pull out the right inner knob to bring up the waypoint scanning window.
- Turn the right inner knob until the first waypoint of the arc is displayed, D011L in this example. For approaches this will have a small (i) appended to the waypoint name. If the recalculation is to be done from the FPL 0 page, then turn on the left cursor and move it over the first waypoint of the arc.
- From either page press **■**. This will change the waypoint to read **MOVE?** (figure 6-27). If it is desired to recompute the arc intercept point then press **■**. If a new arc intercept point is not desired then press **■** again.
- If **■** was pressed, then the KLN 90B will calculate an arc intercept point based on the present track of the aircraft over the ground.

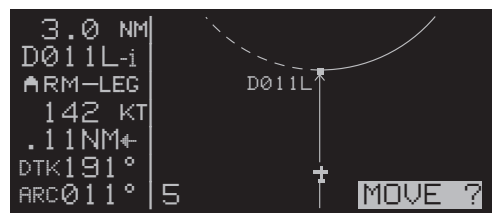

Figure 6-27

NOTE: *If the present track does not intercept the arc, then the KLN 90B will display **NO INTRCPT** in the scratch pad area of the screen.*

8. When the aircraft approaches the arc the KLN 90B will provide waypoint alerting and turn anticipation to join the arc.

9. Once established on the arc the KLN 90B provides left/right guidance relative to the curved arc. Distance to the active waypoint is the distance from the present position to the active waypoint, NOT the distance along the arc. Refer to Appendix A for the geometry of the arc.

10. During the arc, the desired track will be constantly changing. To help you keep the orientation correct the Super NAV 5 will automatically display DTK on the sixth line. It is not possible to change this to something else while on the arc. The value displayed for the desired track will flash when the difference between the CDI or HSI and the current desired track is greater than 10°.

11. Some DME arcs have defined radials that serve as step down fixes. These points are not stored in the database. To help you determine your position relative to these step-down points along the arc, the KLN 90B will display a new value on the bottom line of the display on the Super NAV 5 page. This new bit of information is denoted by the letters **ARC** followed by three numbers. The three numbers represent the current radial that you are on relative to the reference VOR/DME. It is not possible to select any other type of information to display on this line like you normally can. The arc radial is forced into this position when the aircraft is 30 NM from the arc. The arc display is shown in figures 6-26 or in figure 6-27. Just watch this value and when it reads the same as one of the step-down points you can descend as necessary. This particular example does not have such points, but there are quite a few approaches that do.

NOTE: *Autopilot performance may not be satisfactory if coupled in the NAV mode while flying the arc. Many autopilots were never designed to fly curved paths. If autopilot performance is not satisfactory while flying DME arcs, select the HDG mode and keep changing the heading bug to keep the D-bar centered.*

12. As the aircraft approaches the end of the arc, the KLN 90B will provide waypoint alerting and turn anticipation to the next leg.

13. When the aircraft is 2 NM from FOW VOR, the FAF, the KLN 90B will attempt to transition to the approach active mode. Since the DME arc procedure is flown entirely in the LEG mode the only possible problem would be if the integrity monitoring did not check out.

14. The visual descent point is identified by the along track distance to the MAP to be 1.5 NM. When the aircraft reaches this point (figure 6-28), and the runway environment is in sight, it is possible to descend for a landing.

If a missed approach is needed use the following steps:

15. The missed approach calls for a climb to 2000 and then a left turn direct to FOW. Since the KLN 90B will not automatically sequence past the MAP, the KLN 90B will provide the correct guidance for the climb.

16. Once 2000 feet has been reached press **■**, the missed approach holding point will be the default direct to waypoint. Press **■** to confirm the direct to waypoint and proceed to the FOW VOR.

NOTE: If ATC gives you instructions for a missed approach that is different from the published missed approach procedure, it is always possible for you to select a different direct to waypoint than the default direct to waypoint.

17. The OBS mode will need to be selected to accomplish the holding pattern. If this is not done before the aircraft getting 4 NM from FOW, the KLN 90B will provide a message reminding you to select the OBS mode.

NOTE: If another attempt at the approach is desired after holding, it is necessary to manually change the active waypoint. When the FAF and the missed approach holding point are at the same place then the KLN 90B will automatically change the active waypoint to the FAF when you change from OBS to LEG. Make sure to make this change as soon as possible to ensure the approach active mode becomes the active mode.

6.1.9 Approach Problems

Very rarely there will be a problem with the integrity of the GPS system while you are conducting non-precision approaches with the KLN 90B. In some cases the KLN 90B will determine that there will not be sufficient integrity monitoring for the leg between the FAF and the MAP, or RAIM is not currently available. In these cases the KLN 90B will not go into the approach active mode and will present the following message:

**RAIM NOT AVAILABLE
APR MODE INHIBITED
PREDICT RAIM ON STA 5**

In these cases you will not be able to finish the approach because there is insufficient integrity monitoring. The STA 5 (Status 5) page provides a means for you to predict when RAIM will be available.

To perform a RAIM prediction on the STA 5 page two pieces of information are needed. The first is the location that the prediction will be for and the second is the time for the prediction.

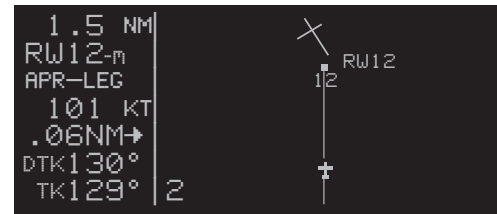

Figure 6-28

The destination waypoint will, by default, be the missed approach point of an approach loaded in the flight plan. If there is no approach in the flight plan, then the default waypoint is the last waypoint in the active flight plan. Of course it is possible for you to enter any waypoint in this field.

The time used for the RAIM prediction will be the current ETA to the destination airport or the MAP. This time is automatically updated by the KLN 90B so there is usually no need to enter a value. If you are making a RAIM calculation for planning purposes, it is also possible to enter a time in this field. An important point about this time is that the time used for RAIM prediction is always in the future and limited to 24 hours from the present time. For example, if the time is now 19:30 and the time entered for the ETA is 18:30, then the prediction will be made for the next day not one hour ago.

To perform a manual RAIM calculation use the following procedure.

1. Turn the left outer and inner knobs to select the STA 5 page.
2. Press the left **█**. The cursor will be over the DEST field.
3. Enter the desired waypoint identifier by using the left inner and outer knobs just like you do for any other waypoint entry.
4. Once the desired waypoint identifier is entered press **█** (figure 6-29). Press **█** again if the waypoint information is correct.
5. The cursor will now be over the ETA field. Use the left inner knob to enter the desired hour. Note that the current time zone is displayed below the ETA field. Use the left outer knob to move the cursor over the minutes field. Use the inner and outer knobs to select tens of minutes and single minutes as required. When the desired time is selected press **█**. The RAIM calculations will start.
6. The RAIM calculation will usually take a few seconds before an answer is reached. During this time the STA 5 page will be as shown in figure 6-30.
7. Once the RAIM calculation is complete, the STA 5 page will indicate the results of the test. This is done graphically in a bar graph format. The center of the bar graph represents the ETA that you entered in step 5. Each bar represents 5 minutes of time. The RAIM calculation is good for ± 15 minutes of the ETA. Bars that are above the line indicate that RAIM is available and bars below the line indicate when RAIM is not available.

An example is shown in figure 6-31. Notice in the figure that the first four bars are below the line and the other three are above the line. This means that RAIM is not available at the ETA, nor during the 15 minutes prior to the ETA. RAIM is predicted to be available five minutes after the ETA and the next 10 minutes. By showing the times when RAIM will be available it is possible for you to alter your ETA to ensure that there will not be any RAIM problems.

Even more rare will be the case when the KLN 90B cannot provide sufficient integrity monitoring or if there is an actual satellite failure while the aircraft is on the leg from the FAF to the MAP. In these cases the KLN 90B will FLAG the navigation solution and a missed approach will have to be flown. The KLN 90B will provide the following message:

PRESS GPS APR FOR NAV

This message is telling you to cancel the approach mode by pressing the external switch/annunciator. This will change the unit to the approach-arm mode and navigation information will be restored.

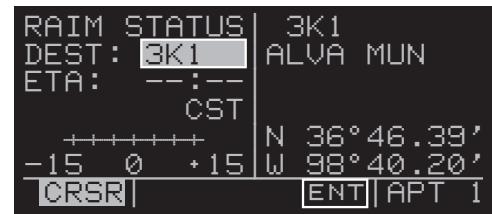

Figure 6-29



Figure 6-30

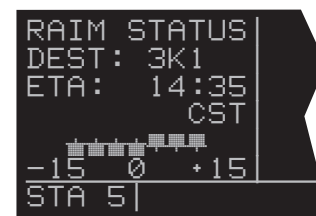

Figure 6-31

6.2 SID/STAR PROCEDURES

The database in the KLN 90B also contains the pilot NAV SIDs (Standard Instrument Departures) and STARs (Standard Terminal Arrival Routes) for the primary database coverage area (see Chapter 2 for database coverage areas). SID/STAR procedures stored in the database can only be considered accurate as long as the database is current. Even though the database contains SID and STAR procedures, there is a lot of information that is not included in the database. Therefore, the paper chart is still the primary source of information. For example, many procedures require the aircraft to fly to a certain altitude, along a heading until intercepting a course, and many other procedures that the KLN 90B can not automatically accomplish. Many procedures require pilot action to ensure that the proper path is flown over the ground. The main purpose of loading a SID or a STAR into the active flight plan is to provide you with a quick way of loading a potentially large number of waypoints.

SID and STAR procedures can be as challenging to fly as some approaches are. Therefore it is mandatory that you are comfortable with the operation of the KLN 90B before attempting to fly SID and STAR procedures. In particular, flight plan operation and the OBS mode should be second nature to you.

NOTE: *There are some SID/STAR procedures in the world that are not suited for the operational characteristics of the KLN 90B. These procedures are not included in the database and therefore the waypoints that make up these procedures would have to be entered manually. It is good preflight practice ensure that the KLN 90B contains anticipated procedures for the flight.*

SID and STAR procedures are stored with the airport for which they apply. SID and STAR procedures are accessed through the APT 7 page. If there are both SIDs and STARs for a given airport, then there will be two APT 7 pages, one to select a SID and the other to select a STAR. This is indicated by APT+7. It is also possible to have only a SID or only a STAR in which case there is only one APT 7 page.

SID and STAR procedures are defined in three parts. The parts are the SID or STAR name (e.g., PORTE9), a transition (e.g., Fellows), and a runway specific component (e.g., RW 01L). The APT 7 pages lead you through the selection process.

6.2.1 Selecting A SID

Use the following procedure to select a SID. Some steps may not be necessary depending on the procedure that you wish to fly. For this example, the PORTE NINE departure from San Francisco International (KSFO) will be used.

1. Select KSFO on one of the airport pages (figure 6-32). If you are operating from an active flight plan you can use the ACT 7 page for KSFO by scanning through the active flight plan (see section 4.2.3).

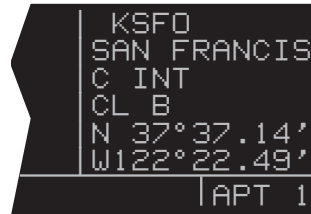

Figure 6-32

2. If not already displayed, rotate the right inner knob until the APT 7 page appears as in figure 6-33. This will allow the selection of SID procedures.

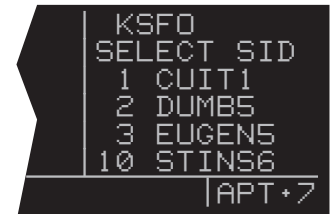

Figure 6-33

3. Turn the right cursor on by pressing the right **█**, and rotate the right outer knob until the flashing cursor is over **PORTE9** (figure 6-34). With the cursor over **PORTE9**, press **█**.



Figure 6-34

4. The KLN 90B will now ask which runway that you will be using. For this example select **RW01B** (figure 6-35) and press **█**.



Figure 6-35

5. The last bit of information needed to define this SID is the transition. This example uses the Fellows transition. To select the Fellows transition, move the cursor down to **FLW** (figure 6-36) and press **█**.

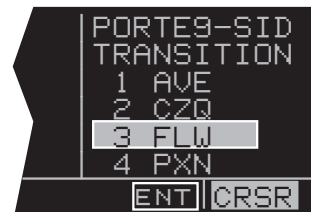

Figure 6-36

6. The KLN 90B now presents a list of waypoints that make up the SID. Review these waypoints if desired. If the waypoints look correct then press **█** with the cursor over **LOAD IN FPL** to load the SID into the active flight plan (figure 6-37).



Figure 6-37

7. The KLN 90B will then add the SID procedure after the airport reference point in the active flight plan (figure 6-38). If the airport reference point is not included in the active flight plan, then the KLN 90B will ask to add this waypoint to the active flight plan.



Figure 6-38

Section 6.2.4 gives the actions required to fly this SID.

6.2.2 Selecting A STAR

The steps required to select a STAR are very similar to those required to select a SID. The only difference is the order of the steps to define the STAR and where the STAR is loaded into the flight plan. The steps required to define Acton Four arrival with the Wink transition serve as an example of how to select a STAR. This STAR is to the Dallas/Fort Worth International airport (KDFW).

Use the following procedure to select a STAR:

1. Select KDFW on one of the airport pages (figure 6-39). If you are operating from an active flight plan you can use the ACT 7 page for KDFW by scanning through the active flight plan (see section 4.2.3).

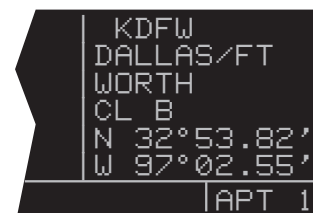

Figure 6-39

2. Turn to the APT 7 page for KDFW. Make sure that the words **SELECT STAR** are displayed near the top of the screen.

3. Turn the right cursor on by pressing the right **█**, and, if necessary, rotate the right outer knob until the flashing cursor is over the desired STAR. With the cursor over AQN4 (figure 6-40), press **█**.

4. The KLN 90B will now ask which transition you want to use. For this example select **INK** (figure 6-41) and press **█**.

5. In some cases, the STAR procedure requires you to select a specific runway. To select a specific runway move the cursor over the desired runway and press **█**. In this example the STAR does not require a specific runway so the KLN 90B skips this step.

6. The KLN 90B now presents a list of waypoints that make up the STAR (figure 6-42). Review these waypoints if desired and then press **█** to load the STAR into the active flight plan.

7. The KLN 90B will then add the STAR procedure before the airport reference point in the active flight plan (figure 6-43). If the airport reference point is not included in the active flight plan, then the KLN 90B will ask to add this waypoint to the active flight plan.

NOTE: It is not possible to load a SID or STAR into a flight plan other than FPL 0. Furthermore, SID and STAR procedures are deleted from FPL 0 after the power is off for more than 5 minutes.

6.2.3 Editing a SID or STAR

From the proceeding two examples you may have noticed that SID and STAR procedures have procedure “headers” just as approaches do. It is possible to use these headers to delete and change the entire procedure just like is done with approach procedures. One difference between SID and STAR procedures and approaches is that it is possible to add waypoints to and delete waypoints from the published procedure. To help you differentiate between approaches (no adding or deleting waypoints allowed) and SID or STAR procedures (adding and deleting waypoints allowed) the waypoint number has a period (.) next to it instead of a blank space. The period also differentiates a SID or STAR waypoint from a “regular” waypoint that has a colon (:) next to the waypoint number.

To add an individual waypoint in the SID or STAR procedure use the following steps:

1. Use the left knobs to select the FPL 0 page on the left side of the screen.
2. Turn the left cursor on by pressing the left **█**. Rotate the left outer knob as necessary to position the cursor over the waypoint identifier which you desire to follow the waypoint being added.

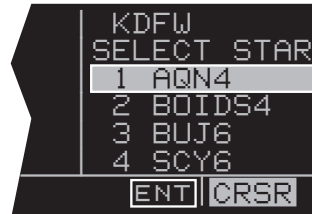

Figure 6-40



Figure 6-41



Figure 6-42



Figure 6-43

3. Use the left inner and outer knobs in the normal manner to define the desired waypoint.

4. Press **■** to display the waypoint page for this identifier. If the waypoint is correct, then press **■** a second time to confirm the waypoint page. The new waypoint is added to the waypoints that make up the SID or STAR procedure.

To delete an individual waypoint in a SID or STAR procedure use the following steps:

1. Use the left knobs to select the FPL 0 page on the left side of the screen.

2. Rotate the left outer knob to place the cursor over the waypoint to be deleted.

3. Press **■**. The letters **DEL** (delete) will appear to the left of the identifier and a question mark will appear to the right of the identifier.

4. If this is the desired waypoint to delete, then press **■**. If it is not the desired waypoint, press **■**.

NOTE: Adding waypoints to or deleting waypoints from SID or STAR procedures does not change the way that they are stored in the published database.

To change or delete an entire SID or STAR procedure from the active flight plan use the following steps:

1. Use the left knobs to select the FPL 0 page on the left side of the screen.

2. Turn the left cursor on by pressing the left **■**. Move the cursor over the SID or STAR procedure header by using the left outer knob.

3. With the cursor over the procedure header, press **■** to change the SID or STAR or press **■** and then **■** to delete the entire procedure.

NOTE: Any waypoints manually added to a SID or STAR will be deleted if the SID or STAR is changed or deleted using the above procedure.

6.2.4 Example of a SID Procedure

To illustrate the use of the KLN 90B with a SID, the Porte Nine departure loaded into the flight plan in section 6.2.1 will be used. This procedure is one of the more difficult that you are likely to come across. Most procedures are not this difficult, but this SID serves as a good example for what steps to take when you encounter a difficult procedure.

To fly this procedure use the following steps and refer to the chart for this SID (figure 6-44):

1. Load the SID as described in section 6.2.1.
2. The procedure states "Intercept and proceed via SFO R-350, cross the 4 DME fix at or above 1600'...". To accomplish this portion of the SID, put the KLN 90B into the OBS mode with SFO04 as the active waypoint and make 350° the selected course. It is easiest to accomplish these steps before take-off. SFO04 is the waypoint that is 4 DME from the SFO VORTAC and 350° is the inbound course to this fix. After take-off climb to 1600' as required by the SID.
3. Once the aircraft reaches SFO04, turn left to a heading of 200°. At this point it is necessary to manually change the active waypoint to "PORTE". This is done easily from either the Super NAV 5 page or from the FPL 0 page. In either case, once PORTE is highlighted in reverse video, press **■** to bring up the direct to page.
4. Press **■** to confirm PORTE as the direct to waypoint.
5. Change the selected course to the new value of 135°. This setup will take the aircraft to the PORTE intersection as directed by the SID.
6. Before reaching PORTE, change back to the Leg mode to enable automatic waypoint sequencing. Once the aircraft reaches PORTE the KLN 90B will automatically sequence to the next waypoint, PESCA.
7. After passing PESCA, the procedure calls for a 090° heading until intercepting the OSI R-116. Once established on the 116° radial proceed to the WAGES intersection. To do this with the KLN 90B, change back to the OBS mode and make sure that WAGES is the active waypoint. Set the selected course to 116°.
8. Before reaching WAGES change to the Leg mode. This will allow automatic waypoint sequencing upon reaching WAGES.

9. There is an altitude restriction marked with an "x" on the chart. The name of this point is 26FLW. 26FLW means that the waypoint is 126 NM from the FLW VOR/DME. Make sure to meet any altitude requirements upon reaching this waypoint.
10. Once the aircraft reaches FLW, proceed on with the rest of the flight plan as required.

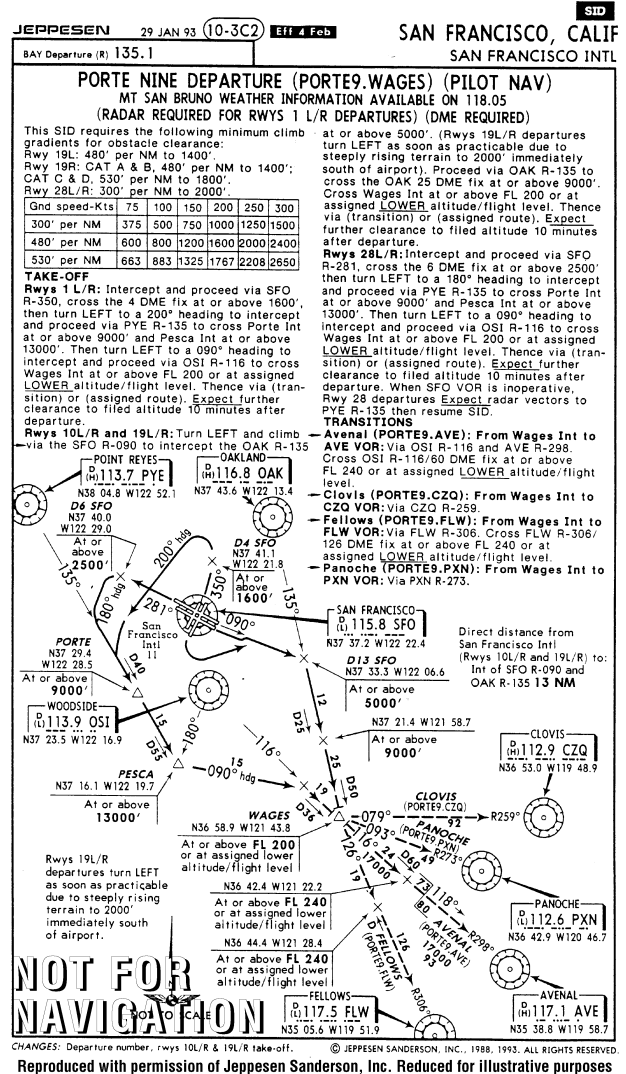

Figure 6-44

6.2.5 Example of a STAR Procedure

To illustrate the use of the KLN 90B with STAR procedures the steps required to fly Acton Four arrival to Dallas/Fort Worth International will be shown in this section. This procedure is considerably simpler than the SID example shown in section 6.2.4.

For this example assume that the aircraft departs from El Paso, Texas and files for the Acton Four arrival with the Wink transition. Use the following steps to fly this procedure with the KLN 90B and refer to the chart for this STAR (figure 6-45):

1. Load the STAR into the flight plan as described in section 6.2.2.
2. This STAR is very simple and the KLN 90B will automatically guide the aircraft along the proper route until the AQN VOR.
3. Long before reaching AQN examine this procedure and notice that there are two different routes depending on what type of aircraft is flying the STAR. Turbojets fly to CREEK intersection while non-turbojets fly to RENDY intersection. The database in the KLN 90B has the sequence of waypoints for the turbojet procedure NOT the sequence for non-turbojets.

NOTE: It is extremely rare to have a different path over the ground for turbojets and non-turbojets, but be sure to cross check with your paper charts.

If the aircraft you are flying in is a turbojet, then fly the rest of the STAR as depicted on the chart with no changes to the flight plan. If the aircraft is not a turbojet then follow these steps:

4. Turn to the FPL 0 page and delete the following waypoints: MARKUM, BRYAR, HULEN, FLATO, and CREEK. To do this turn on the left cursor and rotate the left outer knob until the cursor is over one of the above waypoints.
5. Press **DEL** and then **DEL** to delete a waypoint.
6. Repeat steps 4 and 5 until all of the unnecessary waypoints are deleted.
7. Now add JERRY, CRESN, and RENDY to FPL 0 by using the left inner and outer knobs and **ADD** as necessary.
8. The rest of the STAR can now be flown.

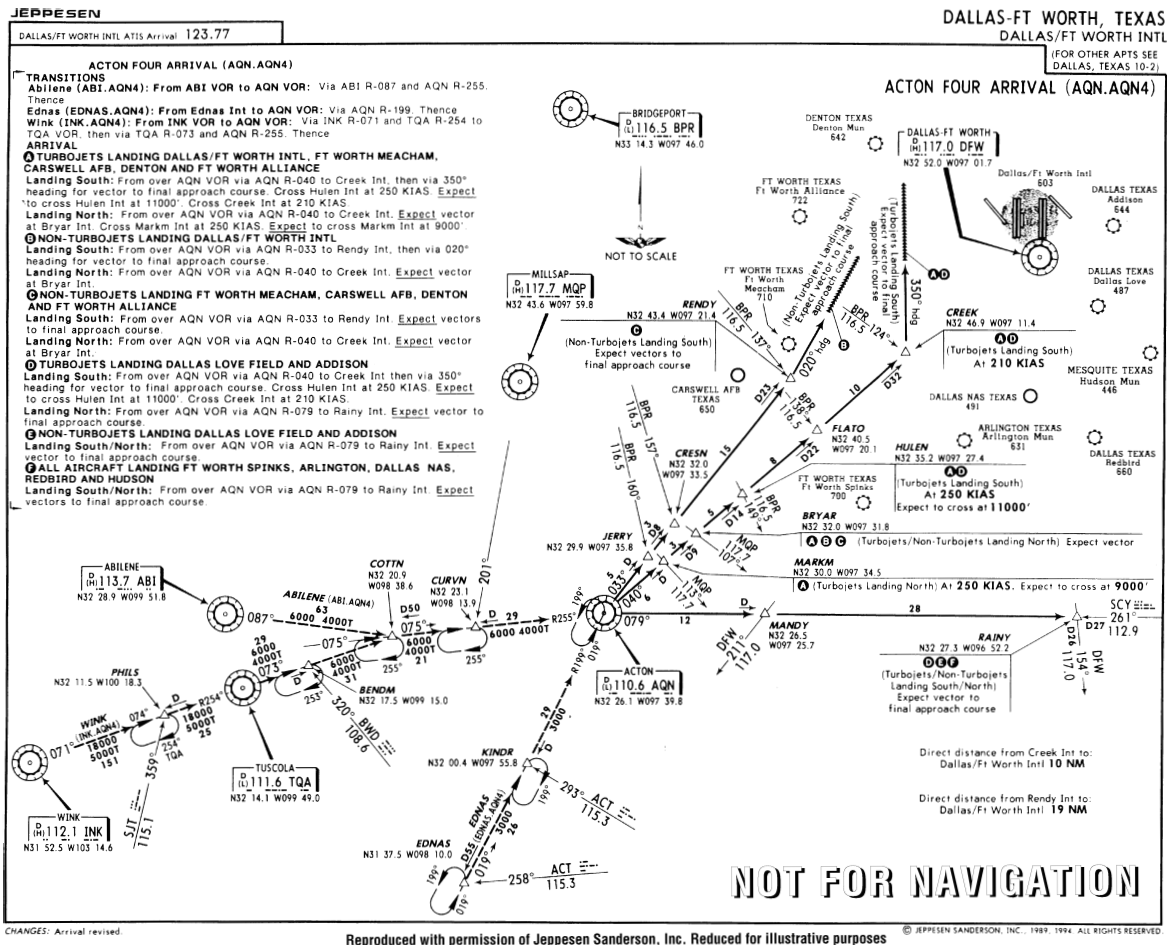

Reproduced with permission of Jeppesen Sanderson, Inc. Reduced for illustrative purposes © JEPPESEN SANDERSON, INC., 1989, 1994. ALL RIGHTS RESERVED. Figure 6-45

APPENDIX A - NAVIGATIONAL TERMS

- BRG - Bearing to waypoint (degrees)
- DA - Drift Angle (degrees) - not displayed on KLN 90B
- DIS - Distance to waypoint (nm)
- DTK - Desired Track (degrees)
- OBS - Selected Course
- GS - Groundspeed (nm/hr)
- HDG - Heading (degrees)
- POS - Present position
- TK - Actual Track (degrees)
- WPT - Waypoint
- XTK - Cross Track Error Correction (nm) displayed as "FLY L 2.3 nm"

- ETE - Estimated Time Enroute (hrs:min)
- ETA - Estimated Time of Arrival
- ARC - Radial from reference VOR when executing an approach procedure with a DME arc

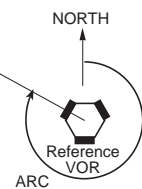
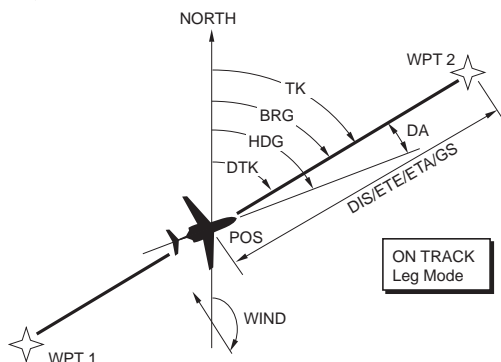
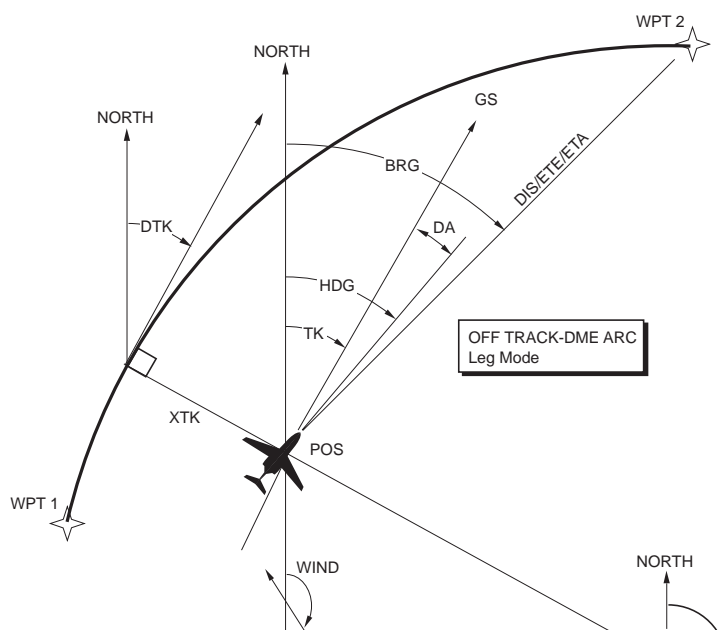
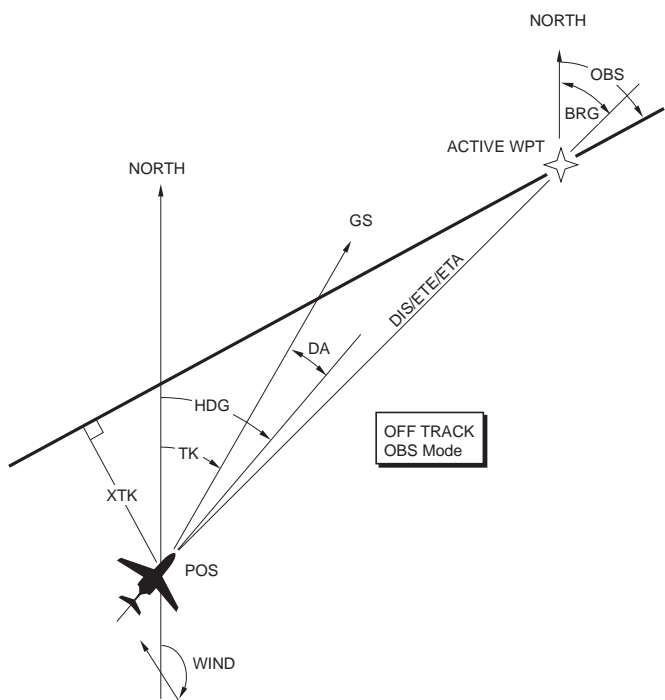
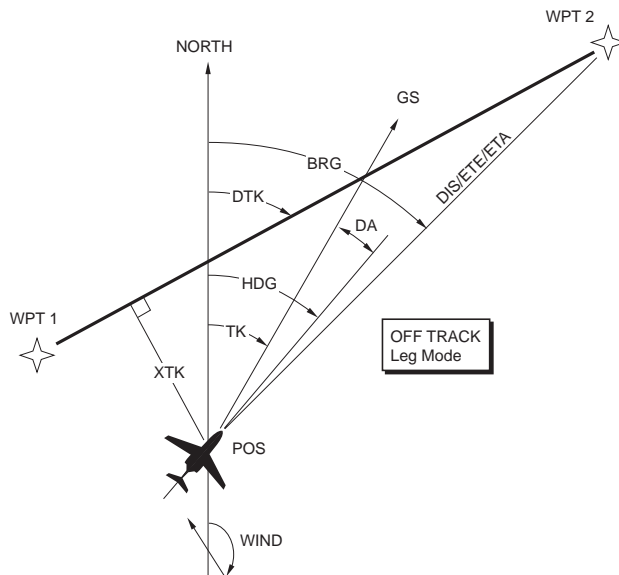

THIS PAGE INTENTIONALLY LEFT BLANK

APPENDIX B - MESSAGE PAGE MESSAGES

The following is a list of the messages that can appear on the Message page. When the message prompt appears, press **MSG** to view the message page. See section 3.5 for an explanation of the Message page.

ACTV ANNUNCIATOR FAIL - This message appears when there is a failure of the KLN 90B ACTV annunciator drive circuitry. To determine if the approach mode is active you will need to look at the status line of the KLN 90B because the annunciator will not be working if this message has been given. Service the KLN 90B as soon as possible.

ADJ NAV IND CRS TO 123° - (Adjust Navigation Indicator Course to 123°) When this message appears, the pilot should select the suggested course on the HSI or CDI. When the KLN 90B is in the Leg mode, this message occurs at the beginning of turn anticipation (prior to reaching the active waypoint) if the upcoming course change is greater than 5°. See section 4.2.2.

This message will also appear in installations where the KLN 90B is interfaced with an HSI such that the KLN 90B has the capability of reading the selected course from the HSI. In the Leg mode it will appear whenever the difference between the HSI's selected course and the KLN 90B's desired track (**DTK**) is greater than five degrees.

ADJ NAV IND CRS - (Adjust Navigation Indicator Course) This message will appear in installations where the KLN 90B is interfaced with EFIS or with a mechanical HSI through the optional KA 90 adapter. This message appears when the difference between the HSI's selected course and the KLN 90B's selected course (**OBS**) is greater than 0.5°. This usually happens only when the external indicator is not slewed to a new value defined by the KLN 90B. Check the interface between the KLN 90B and the external indicator to determine the problem.

AIRSPACE ALERT - This message appears when the estimated time to enter a special use airspace is approximately 10 minutes or when the distance from an area of special use airspace is less than two nautical miles. See section 3.10.

ALTITUDE FAIL - This message appears if the altitude input to the KLN 90B fails. The altitude related features of the KLN 90B will be disabled. There also may be more RAIM related messages since altitude is not available to help in the integrity calculations. Have the installation checked as soon as practical to determine the cause of the problem.

APT ELEVATION UNKNOWN - (Airport Elevation Unknown) This message appears if the elevation of the airport which would otherwise be used for the height above airport alert is unknown.

ARINC 429 AIR DATA FAIL - This message appears if the KLN 90B is interfaced with an air data system having ARINC 429 outputs and the outputs are not being received correctly by the KLN 90B.

ARINC 429 OUTPUT FAIL - This message appears when the ARINC 429 output fails an internal test. Anything depending on the KLN 90B's ARINC 429 output, such as the EHI 40/50 electronic HSI and some navigation graphics displays, should not be used.

ARM ANNUNCIATOR FAIL - This message appears when there is a failure of the KLN 90B ARM annunciator drive circuitry. To determine if the approach mode is armed you will need to look at the status line of the KLN 90B because the annunciator will not be working if this message has been given. Service the KLN 90B as soon as possible.

ARM GPS APPROACH - If the approach ARM mode has been disarmed then the KLN 90B will remind you to ARM the approach mode when the aircraft is 3 NM from the Final Approach Fix. Arm the approach mode if it is desired to use the KLN 90B for conducting an approach.

BAD SATELLITE GEOMETRY

AND RAIM NOT AVAILABLE - This message appears only when the unit is in the approach active mode, RAIM is not available and the satellite geometry has further degraded to cause more uncertainty of the aircraft position. This message may be followed by a NAV flag (in a couple of minutes) if conditions continue to degrade.

BAD SATELLITE GEOMETRY

SEE EPE ON STA 2 PAGE - This message will occur after receiving a notice that RAIM is not available. This means that the geometry of the satellites is such that the possible error in position is greater than allowed for IFR use. Cross check the position of the aircraft with other means of navigation every 15 minutes to verify that the position is still accurate.

BATTERY LOW: SERVICE REQUIRED TO PREVENT

LOSS OF USER DATA - This message appears when the KLN 90B's internal battery is low and needs replacing at an authorized Bendix/King service center. The battery should be replaced within a week to prevent the loss of all user-defined data including waypoints, airport remarks, flight plans, etc. Typical battery life is approximately three to five years.

CHECK ACTV ANNUNCIATOR - This message appears when an overcurrent condition is detected on the ACTV annunciator output. It is usually indicative of a failure of the wiring between the KLN 90B and the ACTV annunciator. To determine if the approach mode is active you will need to look at the status line of the KLN 90B because the annunciator will not be working if this message has been given. Have the installation checked to determine the problem.

CHECK ARM ANNUNCIATOR - This message appears when an overcurrent condition is detected on the ARM annunciator output. It is usually indicative of a failure of the wiring between the KLN 90B and the ARM annunciator. To determine if the approach mode is armed you will need to look at the status line of the KLN 90B because the annunciator will not be working if this message has been given. Have the installation checked to determine the problem.

CHECK MSG ANNUNCIATOR - (Check Message Annunciator) This message appears when an overcurrent condition is detected on the MSG annunciator output. It is usually indicative of a failure of the wiring between the KLN 90B and the MSG annunciator. To determine if message alerting is being given you will need to look at the KLN 90B because the annunciator will not be working if this message has been given. Have the installation checked to determine the problem.

CHECK WPT ANNUNCIATOR - (Check Waypoint Annunciator) This message appears when an overcurrent condition is detected on the WPT annunciator output. It is usually indicative of a failure of the wiring between the KLN 90B and the WPT annunciator. To determine if waypoint alerting is being given you will need to look at the KLN 90B because the annunciator will not be working if this message has been given. Have the installation checked to determine the problem.

DATA BASE CHECKSUM ERR - (Data Base Checksum Error) This message appears if the data base fails an internal test when the KLN 90B is turned on. The most likely cause of the message is a failed data base cartridge.

DATA BASE OUT OF DATE ALL DATA MUST BE

CONFIRMED BEFORE USE - This message appears when the data base is out of date as a result of a date and time entered on the SET 2 page or Self-Test page or as a result of a pilot-entered date being overridden by a date from the GPS receiver.

EEPROM FAILURE: IC _____ EXTERNAL D-BAR INVALID - This message appears in the event a specific internal test fails. The blanks will contain the designator of one of the electrical components. Record the data before turning the unit off in order to assist maintenance personnel. Do not use an external HSI or CDI while it is driven by the KLN 90B. The rest of the KLN 90B is still usable including the internal CDI; however, the page displays may not be centered on the screen.

IF REQUIRED SELECT OBS - This message appears when the aircraft is 4 NM from a waypoint which could be used as the basis for either a procedure turn or a holding pattern and the unit is in the LEG mode. Select the OBS mode when flying procedure turns or holding patterns. This message is advisory only. If no procedure turn is required then no action is required.

INSIDE SPC USE AIRSPACE
[name and type of special use airspace]
[ATC responsible] [Vertical boundaries] - (Inside Special Use Airspace) This message appears when the aircraft's present position is inside an area of special use airspace. See section 3.10.

MAGNETIC VAR INVALID ALL DATA REFERENCED TO TRUE NORTH - This message appears when the magnetic variation is invalid due to operation outside of the data base magnetic variation area without having a pilot-entered magnetic variation. See section 5.12.

MSG ANNUNCIATOR FAIL - (Message Annunciator Failure) This message appears when there is a failure of the KLN 90B MSG annunciator drive circuitry. To determine if message alerting is being given you will need to look at the KLN 90B because the annunciator will not be working if this message has been given. Service the KLN 90B as soon as possible.

NAV SUPER FLAG FAILURE - This message appears when an internal test fails for a specific NAV flag output. The KLN 90B is still usable, but anything connected to the super flag (such as some HSIs and autopilots) should not be used with the KLN 90B.

NO RCVR DATA - (No Receiver Data) This message appears when the KLN 90B fails a specific internal test for the GPS receiver. This failure will prevent the unit from providing any navigation capability.

NO RS-232 DATA - This message appears when no input is received on the RS-232 input (such as from a fuel management or air data system).

OBS WPT > 200NM (OBS Waypoint Greater Than 200 NM) This message appears when the KLN 90B is in the OBS mode and the distance to the active waypoint is more than 200 nautical miles. The system will perform normally; however, at this distance the D-Bar will be extremely sensitive to changes in selected course.

OTHER WAYPOINTS DELETED - This message appears when the message "WAYPOINT _____ DELETED" would be effective for more than ten waypoints.

POSITION DIFFERS FROM LAST POSITION BY > 2NM - (Position Differs From Last Position By Greater Than 2 NM) This message appears when the GPS sensor first reaches the NAV mode if the new position differs from the position when power was turned off by more than two nautical miles.

POSITION OF WPT HAS CHANGED - (Position of Waypoint Has Changed) This message appears when either the latitude or the longitude of a waypoint used in a flight plan or the active waypoint has changed by more than .33 minutes as a result of updating the database. This message is displayed on the left side of the screen while the waypoint page corresponding to the waypoint which changed is displayed on the right side of the screen.

POSITIONS OF OTHER WAYPOINTS HAVE CHANGED - This message appears when the above message "POSITION OF WPT HAS CHANGED" would be effective for more than ten waypoints.

PRESS ALT TO SET BARO - This message appears when the approach mode is armed. Press the ALT button to update the baro information for proper integrity monitoring.

PRESS GPS APR FOR NAV - This message appears after the NAV flag has been set due to a RAIM problem while the unit is in the approach mode. By pressing the GPS APR button, the unit will be able to restore navigation information so that you can conduct a missed approach based on navigation information provided by the KLN 90B.

RAIM NOT AVAILABLE APR MODE INHIBITED PREDICT RAIM ON STA 5 - This message appears when integrity monitoring (RAIM) is predicted to not be available at either the FAF or the MAP. The KLN 90B will not allow the unit to go into the approach active mode until conditions improve. Turn to the STA 5 (Status 5) page to perform a RAIM prediction. The STA 5 page will give an indication of how long it will be until RAIM is available so that the approach can be flown using the KLN 90B (see section 6.1.9 for how to perform a RAIM prediction).

RAIM POSITION ERROR CROSS CHECK POSITION - This message means that the unit has detected a problem with one of the satellites and the position can not be assured to be within IFR limits for the particular mode of flight. Cross check the position of the aircraft with other means of navigation every 15 minutes to verify that the position is still accurate.

RAIM NOT AVAILABLE CROSS CHECK POSITION - This message appears when there are not enough received GPS satellite signals to compute integrity (RAIM). Cross check the position of the aircraft with other means of navigation every 15 minutes to verify that the position is still accurate.

RCVR HARDWARE ERROR:_____ - (Receiver Hardware Error) This message appears when the KLN 90B fails a specific internal test for the GPS receiver. The blank will contain a numerical value which may provide assistance to maintenance personnel.

RECYCLE POWER TO USE CORRECT DATA BASE DATA - This message appears when the date entered on the Self-Test page is before the data base effective date and the date entered later on the SET 2 page is after the data base effective date, or vice versa. Turn the KLN 90B off and back on so that the correct data base data is utilized.

REDUNDANT WPTS IN FPL EDIT ENROUTE WPTS AS NECESSARY - This message appears after the pilot inserts an approach or SID/STAR procedure in the flight plan and the KLN 90B determines that some waypoints that were in the flight plan are no longer needed. Examine the active flight plan and remove those waypoints that occur both in the enroute and the approach or SID/STAR sections of the flight plan.

RS-232 DATA ERROR - This message appears when an error is detected in the received RS-232 data such as from a fuel management or air data system.

RS-232 OUTPUT ERROR - This message appears when the RS 232 output fails an internal test. Anything connected to the RS 232 output bus, such as some moving map displays and ELTs (for position reporting), will not be fully functional. Do not use moving map displays that depend on the KLN 90B's RS 232 output if this message is displayed.

SATELLITE COVERAGE

INADEQUATE FOR NAV - This message appears when the received GPS signals are not adequate for navigation. Occasions when this message will be displayed include when there are an insufficient number of satellites (including altitude input) or when the satellite geometry is inadequate for accurately determining position within 3.8 nautical miles.

SET FUEL ON BOARD

ON OTH 5 IF NECESSARY - This message appears when the KLN 90B determines that it is interfaced with a compatible Shadin fuel flow computer that allows the KLN 90B to set the fuel on board. The pilot should turn to the OTH 5 page to enter the current fuel on board for proper fuel computations (see section 5.10).

SYSTEM TIME UPDATED

TO GPS TIME - The message appears when the KLN 90B system time is automatically updated to GPS time by more than 10 minutes.

USER DATA LOST - This message appears when the unit determines that the internal memory backup battery is dead or that some other internal failure has occurred which has caused all user-entered data including waypoints, flight plans, airport remarks, etc., to be lost.

VNV ALERT- (Vertical Navigation Alert) This message appears when a VNAV operation has been programmed on the NAV 4 page and the estimated time to start the climb or descent is approximately 90 seconds. This message serves as notification to select the NAV 4 page so that the VNAV operation may be executed. This message does not appear if the NAV 4 page is already being displayed. VNAV status can also be displayed on the Super NAV 5 page.

WAYPOINT _____ DELETED - This message appears when a waypoint used in a flight plan, or the active waypoint, no longer exists as a result of updating the data base. The blank space is filled in with the waypoint identifier. The waypoint is deleted from flight plans in which it was used.

WPT ANNUNCIATOR FAIL - (Waypoint Annunciator Failure) This message appears when there is a failure of the KLN 90B WPT annunciator drive circuitry. To determine if waypoint alerting is being given you will need to look at the KLN 90B because the annunciator will not be working if this message has been given. Service the KLN 90B as soon as possible.

APPENDIX C - STATUS LINE MESSAGES

Status line messages are short operational messages that are displayed in the lower center segment of the screen. (See section 3.3 and figure 3-37). The following are the status line messages that may appear.

ACTIVE WPT - (Active Waypoint) Appears when you try to delete a user-defined waypoint on the OTH 3 page if the waypoint is the active waypoint (waypoint you are navigating to). Another waypoint must be made the active waypoint before this waypoint can be deleted from the user-defined waypoint list.

→ CRS XXX° - (Direct To course XXX°) Appears when the KLN 90B is in the OBS mode and is interfaced with an external indicator which the KLN 90B cannot change the selected course and the pilot performs a Direct-To operation. Since the KLN 90B cannot change the selected course to the direct-to course, the KLN 90B gives you this message telling you the OBS value that will take the aircraft direct to the active waypoint.

DUP IDENT - (Duplicate Identifier) Appears when you have selected a waypoint identifier on one of the waypoint type pages if there is more than one waypoint of that waypoint type having the same identifier.

ENT LAT/LON - (Enter Latitude and Longitude) Appears when a user-defined waypoint is being created, to remind you to enter the location of the waypoint.

FPL FULL - (Flight Plan Full) Appears when an attempt is made to add a new waypoint to a flight plan which already contains 30 waypoints and the first waypoint is part of the active leg. Change the active waypoint or delete another waypoint before adding any more waypoints.

IN ACT LIST - (In Active List) Appears when a user-defined VOR waypoint is the active waypoint if you try to change the stored magnetic variation of this VOR. If you need to change the magnetic variation of this waypoint, you must first make another waypoint active.

INVALID ADD - Appears when an attempt is made to add a new waypoint into the approach. Approach procedures must be flown as they are retrieved from the database.

INVALID DEL - (Invalid Delete) Appears when an attempt is made to delete an approach waypoint. Individual approach waypoints cannot be deleted, you must delete (or replace) the entire approach.

INVALID ENT - (Invalid Enter) Appears when you have attempted to enter data which is not a valid entry. For example, trying to enter a date of 30 FEB 92.

INVALID REF - (Invalid Reference) Appears when you attempt to create a reference waypoint on the Reference Waypoint page if the waypoint you have chosen to use as the reference is not a valid choice. The waypoint is not a valid choice if it is impossible to draw a perpendicular line from the waypoint you have entered to one of the legs of the flight plan. A waypoint is also invalid for use as a reference if the letters A through Z cannot be appended to the waypoint identifier to create a unique identifier. See section 5.5.

INVALID VNV - (Invalid Vertical Navigation) Appears when a waypoint identifier has been entered on the NAV 4 page if the waypoint identifier is not valid for use in a VNAV operation. For the Enroute-Leg mode, the waypoint must be the active waypoint or a waypoint positioned in the active flight plan ahead of the aircraft's location. In the Enroute-OBS mode, the waypoint must be the active waypoint.

NO ACTV WPT - (No Active Waypoint) Appears when you attempt to activate the OBS mode if there is no active waypoint. To have an active waypoint, a flight plan must be activated or a Direct To operation must be accomplished.

NO APPROACH - Appears when an attempt is made to arm the GPS approach mode when there is no approach loaded into the active flight plan. Load an approach into the flight plan before trying to arm the approach mode.

NO APT WPTS - (No Airport Waypoints) Appears when the APT type pages have been selected if the KLN 90B doesn't contain a data base cartridge and there are no user-defined airport waypoints.

NO INT WPTS - (No Intersection Waypoints) Appears when the INT type pages have been selected if the KLN 90B doesn't contain a data base cartridge and there are no user-defined intersection waypoints.

NO INTRCEPT - (No Intercept) Appears when an attempt is made to recalculate the intercept point on a DME arc and the actual track does not intercept with the arc. Change the track (heading) of the aircraft so that the actual track does intercept the DME arc and try again.

NO NDB WPTS - (No NDB Waypoints) Appears when the NDB type pages have been selected if the KLN 90B doesn't contain a data base cartridge and there are no user-defined NDB waypoints.

NO SUCH WPT - (No Such Waypoint) Appears when there is no waypoint in the data base corresponding to the entered identifier on the Reference Waypoint page.

NO SUP WPTS - (No Supplemental Waypoints) Appears when the SUP type pages have been selected if the KLN 90B doesn't contain a data base cartridge and there are no user-defined supplemental waypoints.

NO VOR WPTS - (No VOR Waypoints) Appears when the VOR type pages have been selected if the KLN 90B doesn't contain a data base cartridge and there are no user-defined VOR waypoints.

OUTDATED DB - (Outdated Database) Appears whenever the pilot attempts to select an approach from the database when the database has expired.

RMKS FULL - (Remarks Full) Appears when an attempt is made to create a user-entered airport remark on the APT 5 page if 100 user-entered airport remarks already exist. In order to create additional airport remarks, some existing remarks must be deleted on the OTH 4 page as described in section 3.11.6.

RWY MISSING - (Runway Missing) Appears when the Airport 3 (APT 3) page runway diagram shows some, but not all, of the runways at the selected airport. This occurs if the data base contains runway threshold position data for only some of the runways at the selected airport.

USED IN FPL - (Used In Flight Plan) Appears when you try to delete a user-defined waypoint on the OTH 3 page if the waypoint is used in a flight plan. Either this waypoint must be deleted from the flight plan or the entire flight plan must be deleted before this waypoint can be deleted from the user-defined waypoint list.

USR DB FULL - (User Data Base Full) Appears when you attempt to create a user-defined waypoint if the user data base already contains 250 waypoints. In order to create additional user-defined waypoints, it will first be necessary to delete existing user-defined waypoints on the OTH 3 page.

APPENDIX D - ABBREVIATIONS

STATE ABBREVIATIONS

<u>ABBREVIATION</u>	<u>STATE</u>
AK	Alaska
AL	Alabama
AR	Arkansas
AZ	Arizona
CA	California
CO	Colorado
CT	Connecticut
DC	District of Columbia
DE	Delaware
FL	Florida
GA	Georgia
IA	Iowa
ID	Idaho
IL	Illinois
IN	Indiana
KS	Kansas
KY	Kentucky
LA	Louisiana
MA	Massachusetts
MD	Maryland
ME	Maine
MI	Michigan
MN	Minnesota
MO	Missouri
MS	Mississippi
MT	Montana
NC	North Carolina
ND	North Dakota
NE	Nebraska
NH	New Hampshire
NJ	New Jersey
NM	New Mexico
NV	Nevada
NY	New York
OH	Ohio
OK	Oklahoma
OR	Oregon
PA	Pennsylvania
RI	Rhode Island
SC	South Carolina
SD	South Dakota
TN	Tennessee
TX	Texas
UT	Utah
VA	Virginia
VT	Vermont
WA	Washington
WI	Wisconsin
WV	West Virginia
WY	Wyoming

CANADIAN PROVINCE ABBREVIATIONS

<u>ABBREVIATION</u>	<u>PROVINCE</u>
AB	Alberta
BC	British Columbia
MB	Manitoba
NB	New Brunswick
NF	Newfoundland
NS	Nova Scotia
NW	Northwest Territory
ON	Ontario
PE	Prince Edward Island
PQ	Quebec
SK	Saskatchewan
YK	Yukon

COUNTRY ABBREVIATIONS

<u>ABBREVIATION</u>	<u>COUNTRY</u>
AFG	Afghanistan
AGO	Angola
AIA	Anguilla I.
ALB	Albania
ANT	Antarctica/Netherlands
	Antilles/Aruba
ARE	United Arab Emirates
ARG	Argentina
ASM	American/Western Samoa
ATG	Antigua/Barbuda
AUS	Australia
AUT	Austria
BDI	Burundi
BEL	Belgium
BEN	Benin
BFA	Burkina Faso
BGD	Bangladesh
BGR	Bulgaria
BHR	Bahrain
BHS	Bahamas
BHU	Bhutan
BLZ	Belize
BMU	Bermuda
BOL	Bolivia
BOS	Bosnia and Herzegovia
BRA	Brazil
BRB	Barbados
BRN	Brunei
BWA	Botswana
CAF	Central African Republic
CAN	Canada
CHE	Switzerland
CHL	Chile/Easter I.
CHN	China
CIV	Ivory Coast

Country Abbreviations - Continued

CMR	Cameroon	KEN	Kenya
CNR	Canary Islands	KHM	Cambodia/Kampuchea
COG	Congo	KIR	Kiribati/Tuvalu/Phoenix I./Line I.
COK	Cook Islands	KNA	St. Kitts/Nevis
COL	Colombia/San Andres	KOR	Korea
CRI	Costa Rica	KWT	Kuwait
CRO	Croatia	LAO	Laos
CSK	Czechoslovakia	LAT	Latvia
CUB	Cuba	LBN	Lebanon
CYM	Cayman Islands	LBR	Liberia
CYP	Cyprus	LBY	Liby/SPA Jamahiriya
DEU	Germany	LCA	St. Lucia
DJI	Djibouti	LKA	Sri Lanka
DMA	Dominica	LSO	Lesotho
DNK	Denmark	LUX	Luxembourg
DOM	Dominican Republic	MAC	Macau
DZA	Algeria	MAR	Morocco
ECU	Ecuador	MDG	Madagascar/Comoros/ Mayotte I./Reunion
EGY	Egypt	MDV	Maldives
ERI	Eritrea	MEL	Melilla
ESP	Spain	MEX	Mexico
ETH	Ethiopia	MHL	Marshall Island
FIN	Finland	MID	Midway Island
FJI	Fiji/Tonga	MLI	Mali
FLK	Falkland Islands	MLT	Malta
FRA	France	MNP	Mariana Islands
GAB	Gabon	MOL	Moldova
GBR	United Kingdom	MOZ	Mozambique
GHA	Ghana	MRT	Mauritania
GIB	Gibraltar	MSR	Monserrat I.
GIN	Guinea	MUS	Mauritius
GLP	Guadeloupe/Martinique	MWI	Malawi
GMB	Gambia	MYR	Myanmar
GNB	Guinea-Bissau	MYS	Malaysia
GNQ	Equatorial Guinea	NAM	Nambia
GPV	Cape Verde	NCL	New Caledonia
GRC	Greece	NER	Niger
GRD	Grenada	NGA	Nigeria
GRL	Greenland	NIC	Nicaragua
GTM	Guatemala	NIU	Niue Island
GUF	French Guiana	NLD	Netherlands
GUY	Guyana	NOR	Norway
HKG	Hong Kong	NPL	Nepal
HND	Honduras	NRU	Nauru
HTI	Haiti	NZL	New Zealand
HUN	Hungary	OMN	Oman
IDN	Indonesia	PAC	Oakland OTCA (PACIFIC)
IND	India	PAK	Pakistan
IOT	British Indian Ocean Territory	PAN	Panama
IRL	Ireland	PCI	Caroline Island/Micronesia
IRN	Iran	PER	Peru
IRQ	Iraq	PHL	Philippines
ISL	Iceland	PNG	Papua New Guinea
ISR	Israel	POL	Poland
ITA	Italy	PRI	Puerto Rico
JAM	Jamaica	PRK	Korea (Dem. Peoples Republic)
JOR	Jordan	PRT	Portugal/Azores/Madeira I.
JPN	Japan/Okinawa	PRY	Paraguay
JTN	Johnston Island		

Country Abbreviations - Continued

**AIR ROUTE TRAFFIC CONTROL CENTER
(ARTCC/FIR) ABBREVIATIONS
(Used on CTR 2 Page)**

PYF	French Polynesia/ Society I./Tuamotu		
QAT	Qatar		
ROM	Romania		
RWA	Rwanda	<u>ABBREVIATION</u>	<u>ARTCC</u>
SAU	Saudi Arabia		
SDN	Sudan	ABQ	Albuquerque
SEN	Senegal	ACC	Accra
SGP	Singapore	ADD	Addis Ababa
SHN	Ascension Island/St. Helena	ADE	Adelaide
SLB	Solomon Islands	ADN	Aden
SLE	Sierra Leone	AKM	Akmola
SLO	Slovenia	AKT	Aktyubinsk
SLV	El Salvador	ALG	Algiers
SOM	Somalia	ALM	Alma-Ata
SPM	St. Pierre/Miquelon	AMD	Amderma
STP	Sao Tome/Principe	AMM	Amman
SUR	Suriname	AMS	Amsterdam
SVK	Slovakia	ANA	Anadyr
SWE	Sweden	ANC	Anchorage Arctic
SWZ	Swaziland	ANC	Anchorage
SYC	Seychelles	ANC	Anchorage Oceanic
SYR	Syria	ANK	Ankara
TCA	Turks and Caicos Islands	ANT	Antananarivo
TCD	Chad	ARK	Arkhangelsk
TGO	Togo	ASH	Ashkhabad
THA	Thailand	ASM	Asmara
TTO	Trinidad/Tabago	AST	Astrakhan
TUN	Tunisia	ASU	Asuncion
TUR	Turkey	ATF	Antofagasta
TWN	Taiwan	ATH	Athens
TZA	Tanzania	ATL	Atlanta
UGA	Uganda	AUC	Auckland Oceanic
URY	Uruguay	AUC	Auckland
USA	U.S.A. including Baker Islands	BAG	Baghdad
VCT	St. Vincent	BAH	Bahrain
VEN	Venezuela	BAK	Baku
VGB	Virgin Islands (U.K.)	BAL	Bali
VIR	Virgin Islands (U.S.)	BAN	Bangkok
VNM	Vietnam	BAR	Barcelona
VUT	Vanautu	BAT	Batagay
WAK	Wake Island	BEI	Beijing
WLF	Wallis/Futuna Islands	BEL	Belem
XJ1	Kazakhstan/Kyrgyzstan	BER	Bermuda
XJ2	Armenia/Georgia	BIA	Biak
XJ3	Ukraine, Moldova	BIS	Bishkek
XJ4	Estonia/Russia	BLA	Blagoveshchensk
XJ5	Belarus/Latvia/Lithuania/Russia	BLG	Belgrade
XJ6	Kazakhstan/Russia	BLO	Bloemfontein
XJ7	Kazakhstan/Tajikistan/ Turkmenistan/Uzbekistan	BOD	Bodo
		BOD	Bodo Oceanic
XJJ	Azerbaijan	BOG	Bogota
XJR	Russia	BOM	Bombay
YEM	Yemen (Arab Republic)	BOR	Bordeaux
YUG	Yugoslavia	BOS	Boston
ZAF	South Africa	BRA	Beira
ZAM	Zambia	BRD	Brindisi
ZAR	Zaire	BRE	Bremen
ZWE	Zimbabwe	BRI	Brisbane

Air Route Traffic Control Center (ARTCC/FIR) Abbreviations - Continued

BRL	Berlin	GUA	Guangzhou
BRN	Barnaul	GUY	Guayaquil
BRR	Barranquilla	HAN	Hanoi
BRS	Brasilia	HAR	Harare
BRT	Beirut	HAV	Havana
BRU	Brussels	HK	Hong Kong
BRV	Bratislava	HNR	Honiara
BRY	Beryozovo	HOC	Hochiminh
BRZ	Brazzaville	HON	Honolulu
BSK	Bratsk	HOU	Houston
BST	Brest	HOU	Houston Oceanic
BUC	Bucharest	IND	Indianapolis
BUD	Budapest	IRK	Irkutsk
BUJ	Bujumbura	ISL	Isla de Pascua
CAI	Cairo	IST	Istanbul
CAL	Calcutta	JAK	Jakarta
CAM	Campo Grande	JAX	Jacksonville
CAM	Central America	JED	Jeddah
CAN	Canaries	JOH	Johannesburg
CAP	Capetown	KAB	Kabul
CAS	Casablanca	KAM	Kamennyi Mys
CHA	Chaybukha	KAN	Kano
CHE	Chelyabinsk	KAR	Karachi
CHI	Chicago	KAT	Kathmandu
CHO	Chokurdakh	KAZ	Kazan
CHR	Chersky	KC	Kansas City
CHT	Chita	KHA	Khabarovsk
CHU	Chulman	KHR	Kharkov
CLE	Cleveland	KHT	Khatanga
COC	Cocos Island	KIE	Kiev
COL	Colombo	KIG	Kigali
COP	Copenhagen	KIN	Kingston
COR	Cordoba	KIR	Kirensk
CRT	Curitiba	KIS	Kisangani
CUR	Curacao	KK	Kota Kinabalu
DAK	Dakar	KL	Kuala Lumpur
DAK	Dakar Oceanic	KM	Khanty-Mansiysk
DAM	Damascus	KNS	Kinshasa
DAR	Darwin	KO	Kzyl-Orda
DEL	Delhi	KOL	Kolpashevo
DEN	Denver	KOS	Kostanay
DES	Dar-Es-Salaam	KRA	Krasnovodsk
DHA	Dhaka	KRS	Krasnoyarsk
DIK	Kikson	KRV	Kirov
DOR	Kornod	KSH	Kishinau
DSS	Dusseldorf	KTM	Khartoum
DUR	Durban	KUN	Kunming
DUS	Dushanbe	KUR	Kurgan
EDM	Edmonton	LAH	Lahore
EMI	Emirates	LAN	Lanzhou
ENT	Entebbe	LAP	LA Paz
EZE	Ezeiza	LAX	Los Angeles
FRA	Frankfurt	LIL	Lilongwe
FW	Ft Worth	LIM	Lima
GAB	Gaborone	LIS	Lisbon
GAN	Gander Domestic	LJU	Ljubljana
GAN	Gander Oceanic	LON	London
GEN	Geneva	LUA	Luanda
GEO	Georgetown	LUB	Lubumbashi

Air Route Traffic Control Center (ARTCC/FIR) Abbreviations - Continued

LUS	Lusaka	OSK	Okhotsk
LVO	Lvov	OSL	Oslo
MAD	Madrid	PA	Punta Arenas
MAG	Magadan	PAN	Panama
MAI	Maiquetia	PAP	Port Au Prince
MAL	Male	PAR	Paris
MAN	Manila	PE	Port Elizabeth
MAR	Marseille	PEC	Pechora
MAU	Mauritius	PEM	Perm
MAZ	Mazatlan	PEN	Penza
MAZ	Mazatlan Oceanic	PER	Perth
MDR	Madras	PET	Petersburg
MEL	Melbourne	PEV	Pevek
MEM	Memphis	PHN	Phnom Penh
MEN	Mendoza	PIA	Piarco
MER	Merida	PM	Port Moresby
MEX	Mexico	PMT	Puerto Montt
MGD	Magdagachi	PRA	Prague
MIA	Miami	PRM	Pamaribo
MIA	Miami Oceanic	PTR	Petropavlovsk-Kam
MIL	Milan	PV	Porto Velho
MIN	Minneapolis	PYO	Pyongyang
MIR	Mirny	REC	Recife
MLM	Malmo	RES	Resistencia
MLT	Malta	REY	Reykjavik
MNC	Moncton Northern	RIG	Riga
MNC	Moncton Southern	RIV	Rivadavia
MNS	Manaus	RMS	Reims
MNT	Monterrey	ROB	Roberts
MOG	Mogadishu	ROC	Rochambeau
MON	Montreal	ROM	Rome
MOS	Moscow	ROS	Rostov
MRM	Murmansk	ROV	Rovaniemi
MS	Mys Shmidta	SAI	Sainshand
MSK	Minsk	SAL	Sal Oceanic
MTV	Montevideo	SAM	Samara
MUN	Munich	SAN	Santiago
MUR	Muren	SCO	Scottish
MUS	Musca	SDO	Santo Domingo
NAD	Nadi Oceanic	SEA	Seattle
NAH	Naha	SEM	Semipalatinsk
NAI	Nairobi	SEY	Seychelles
NAS	Nassaut	SHA	Shanghai
NDJ	N'Djamena	SHE	Shenyang
NIC	Nicosia	SHN	Shannon
NIK	Nikolaevsk-Na-Amure	SHW	Shanwick Oceanic
NMY	Niamey	SIM	Simferopol
NOR	Norilsk	SIN	Singapore
NOV	Novosibirsk	SJU	San Juan Oceanic
NUK	Nukus	SLC	Salt Lake City
NY	New York	SLK	Salekhard
NY	New York Oceanic	SM	Santa Maria Oceanic
NZE	New Zeland	SMR	Samarkand
OAK	Oakland	SOF	Sofia
OAK	Oakland Oceanic	SON	Sondrestrom
ODE	Odessa	STA	Stavanger
OKH	Okha	STO	Stockholm
OMS	Omsk	SUK	Sukhumi
ORN	Orenburg	SUN	Sundsvall

Air Route Traffic Control Center (ARTCC/FIR) Abbreviations - Continued

SUR	Surgut	OTHER ABBREVIATIONS USED ON KLN 90B	
SWI	Switzerland	PAGES	
SYD	Sydney		
SYK	Syktyvkar	80	80 octane fuel
SYM	Seymchan	100	100 octane fuel
TAE	Taegu	100LL	100 octane low lead fuel
TAH	Tahiti Oceanic	A	Airport waypoint
TAI	Taipei	AAS	Aeronautical advisory service
TAL	Tallinn	ABV	Above
TAM	Tampere	ACQ	Acquisition
TAS	Tashkent	ACT	Active flight plan waypoints
TAZ	Tashavz	ADJ	Adjust
TBI	Tbilisi	AKD	Alaska Daylight Time
TEH	Tehran	AKS	Alaska Standard Time
TEL	Tel Aviv	ALRT	Alert area
TIK	Tiksi	ALT	Altitude
TIL	Tilichiki	ANNUN	Annunciators
TIR	Tirana	APPR	Approach
TOK	Tokyo	APR	Approach
TOR	Toronto	APT	Airport
TRI	Tripoli	ARM	Approach Arm Mode
TRO	Trondheim	ARVL	Arrival (freq)
TUN	Tunis	ATD	Atlantic Daylight Time
TUR	Turukhansk	ATF	Aerodrome traffic frequency
TYU	Tyumen	ATS	Atlantic Standard Time
UFA	Ufa	AWOS	Automatic weather observing station
UJU	Ujung Bandang		
ULA	Ulaanbaatar	B	Bad
UND	Underhaan	B	Both
URA	Uralsk	BARO	Barometer (altimeter setting)
URU	Urumqi	BEL	Below
VAN	Vancouver	BRG	Bearing
VAR	Varna	C	Centigrade
VEL	Velikiye Luki	CAL	Calculator
VIE	Vienna	CAL	Calibration
VIL	Vilnius	CAS	Calibrated airspeed
VLA	Vladivostok	CAUT	Caution area
VNT	Vientiane	CDI	Course Deviation Indicator
VLO	Vologda	CDT	Central Daylight Time
VOL	Volgograd	CL B	Class B airspace
VRK	Vorkuta	CL C	Class C airspace
WAR	Warsaw	CLR	Clearance delivery
WAS	Washington	CLY	Clay
WEL	Wellington	CONV	Conversion
WIN	Winnipeg	CORD UNIV	Coordinated Universal Time
WND	Windhoek	CRS	Course
WUH	Wuhan	CRSR	Cursor
YAK	Yakutsk	CST	Central Standard Time
YAN	Yangon	CTA	Control area (outside USA)
YEK	Yekaterinburg	CTAF	Common traffic advisory frequency
YEN	Yeniseysk		
YER	Yerevan	CTR	Center (Air Route Traffic Control Center)
YS	Yuzhno-Sakhalinsk		
ZAG	Zagreb	D	DME capable
ZAI	Zaire	D/T	Distance/Time
ZHK	Zhezkazgan	DB	Database
ZUR	Zurich	DEGRD	Degraded navigation
ZYR	Zyryanka	DEN	Density Altitude
		DEP	Departure

Other Abbreviations Used on KLN 90B Pages - Continued

DEST	Destination	INIT	Initialization
DEV	Deviation (on external course deviation indicator)	INT	Intersection
DIR	Director (freq)	INVRT	Invert
DIS	Distance	KG	Kilogram
DNGR	Danger area	KT	Knots
DTK	Desired track	L	Left
DUP	Duplicate	L	Liters
E	East	L	Low altitude VOR
EDT	Eastern Daylight Time	L	Low pressure oxygen
ELE	Elevation	L	Runway lighting sunset to sun rise
ELEV	Elevation	L FOB	Landing fuel on board
ELV	Airport elevation	LB	Low pressure bottled oxygen
ENDUR	Endurance	LB	Pounds
ENG	Engine	LDG	Landing
ENR	En route	LEN	Length
ENT	Enter	LPC	Runway lighting is pilot controlled
ESA	Minimum en route safe altitude	LPT	Runway lighting is part time or on request
EST	Eastern Standard Time	MACH	Mach number
ETA	Estimated time of arrival	MAHP	Missed Approach Holding Point
ETE	Estimated time en route	MAP	Missed Approach Point
F	Fahrenheit	MAT	Steel matting
FAF	Final Approach Fix	MB	Millibars
FAILR	Failure of receiver	MCOM	Multicom
FF	Fuel Flow	MDT	Mountain Daylight Time
FLT	Flight time	MF	Mandatory frequency
FOB	Fuel on board	MOA	Military operation area
FP	Flight plan	MOD	Mode
FPL	Flight plan	MOGAS	Automotive fuel
FPM	Feet per minute	MPH	Miles per hour
FR	From	MSA	Minimum safe altitude
F REQ	Fuel required	MSG	Message
FSS	Flight service station	MST	Mountain Standard Time
G	GPS based approach procedure	N	NDB overlay approach procedure
GAL	Gallon	N	NDB waypoint
GDT	Greenland Daylight Time	N	North
GPS	Global Positioning System	NAV	Navigation
GPS CRS	External Leg/OBS switch	NAV A	Navigation with altitude aiding
GRND	Ground control	NAV D	Navigation with data collection
GRV	Gravel	NM	Nautical miles
GS	Groundspeed	NR	Nearest
GST	Greenland Standard Time	OBS	Omni bearing selection
H	High altitude VOR	ORS	Operational Revision Status
H	High pressure oxygen	OTH	Other
HAD	Hawaii Daylight Time	P.POS	Present position
HAS	Hawaii Standard Time	PCL	Pilot controlled lighting
HB	High pressure bottled oxygen	PDT	Pacific Daylight Time
HDG	Heading	POS	Position
HDWND	Headwind	POSN	Position
HRD	Hard surface	PRES	Present
HSI	Horizontal Situation Indicator	PROH	Prohibited area
HT	Height	PRS	Pressure altitude
I	Intersection waypoint	PST	Pacific Standard Time
IAF	Initial Approach Fix	PTAX	Pre-taxi clearance
IDENT	Identifier	PWR	Power
IMP	Imperial gallon	R	Right
INACTV	Inactive		
IND	Indicated altitude		

Other Abbreviations Used on KLN 90B Pages - Continued

R	RNAV overlay approach procedure	V	VNAV status (on Super NAV 5)
(R)	Radar environment to approach & departure	V	VOR approach overlay procedure
RAD	Radial	V	VOR waypoint
RAIM	Receiver Autonomous Integrity Monitoring	VERT	Vertical
RAMP	Ramp/taxi control (freq)	VNV	Vertical navigation (VNAV)
RCVR	Receiver	W	Weak
RDR	Radar (freq)	W	West
REF	Reference	WARN	Warning area
REQD	Required fuel	WPT	Waypoint
RES	Reserve fuel	WRN	Warn
REST	Restricted area	XTK	Cross track error correction
RMI	Radio magnetic indicator	Z	Zulu time
RMKS	Remarks		
RW	Runway		
S	South		
S	Supplemental waypoint		
SAT	Static air temperature		
SDT	Samoa Daylight Time		
SEL	Selected altitude		
SEQ	Sequence		
SET	Setup		
SFT	Soft surface		
SHL	Shale		
SID	Standard Instrument Departure		
SND	Sand		
SNR	Signal-to-noise-ratio		
SNW	Snow		
SPC USE	Special Use (airspace)		
SRCH	Search the sky		
SST	Samoa Standard Time		
STA	Status		
STAR	Standard Terminal Arrival Route		
STN	Station		
SUP	Supplemental		
SV	Space vehicle		
SW	Software		
T	Terminal VOR		
T	Terminal waypoint		
t	Relative to true North		
TAS	True airspeed		
TAT	Total air temperature		
TEMP	Temperature		
TK	Actual track		
TLWND	Tailwind		
TMA	Terminal area (outside USA)		
TRAN	Transition		
TRF	Turf		
TRI	Trip		
TRNG	Training area		
TRSA	Terminal Radar Service Area		
TWR	Tower		
U	Undefined class of VOR		
UNIC	Unicom		
UNK	Unknown		
UTC	Coordinated Universal Time (Zulu)		

APPENDIX E - SECONDS TO DECIMAL MINUTES

The KLN 90B utilizes latitude and longitude expressed in degrees, minutes, and hundredths of a minute. You may occasionally see a document expressing latitude and longitude in degrees, minutes, and seconds. You may use this table to convert seconds to hundredths of a minute.

SECONDS	HUNDREDTHS OF A MINUTE
00	.00
01	.02
02	.03
03	.05
04	.07
05	.08
06	.10
07	.12
08	.13
09	.15
10	.17
11	.18
12	.20
13	.22
14	.23
15	.25
16	.27
17	.28
18	.30
19	.32
20	.33
21	.35
22	.37
23	.38
24	.40
25	.42
26	.43
27	.45
28	.47
29	.48
30	.50
31	.52
32	.53
33	.55
34	.57
35	.58
36	.60
37	.62
38	.63
39	.65
40	.67
41	.68
42	.70
43	.72
44	.73

45	.75
46	.77
47	.78
48	.80
49	.82
50	.83
51	.85
52	.87
53	.88
54	.90
55	.92
56	.93
57	.95
58	.97
59	.98

For Example:

35 deg, 46 min, 24 seconds becomes 35 deg, 46.40 min
 32 deg, 15 min, 58 seconds becomes 32 deg, 15.97 min

THIS PAGE INTENTIONALLY LEFT BLANK

INDEX

A

Abbreviations
 Airport names 3-26, 3-42
 ARTCC/FIR D-3
 Canadian province D-1
 Country D-1
 Other KLN 90B D-6
 State D-1
ACT page (active flight plan waypoints) 4-10
Actual track 3-32, 3-34, A-1
Air data pages 5-42
Airport
 City 3-43
 Communication frequencies 3-45
 Elevation 3-43
 Instrument approach capability 3-43
 Name 3-42
 Nearest 3-22, 3-37, 3-42
 Radar capability 3-43
 Remarks 3-47
 Runway information 3-43
 Services 3-48
 User defined waypoints 5-16
Airport identifiers 2-3
Airspeed 5-11, 5-13, 5-43
Alerting
 Altitude 3-55
 Height above airport 3-58
 Special use airspace 3-39
 Waypoint 3-29, 4-8
Almanac 3-17
Altitude
 Alerting 3-55
 Density 5-10, 5-43
 Indicated 3-55
 Minimum enroute 3-32
 Minimum safe 3-32
 Page 3-55
 Pressure 5-10, 5-43
Annunciators, remote 3-59, 6-1
Antennas 1-2
Approach active (ACTV) mode 3-29, 5-32, 5-38, 6-1, 6-3, 6-8
Approach armed (ARM) mode 3-29, 5-32, 5-38, 6-1, 6-8
Approaches 2-2, 3-49, 5-45, 6-1
 Changing 6-7
 Deleting 6-7
 Loading 6-4
 Selecting 6-4
APT 1 page (Airport 1) 3-42

APT 2 page (Airport 2) 3-43
APT 3 page (Airport 3) 3-43
APT 4 page (Airport 4) 3-45
APT 5 page (Airport 5) 3-47
APT 6 page (Airport 6) 3-48
APT 7 page (Airport 7) 3-49, 6-21
APT 8 page (Airport 8) 3-49, 6-4, 6-16
ARC 6-18, A-1
ARTCC ("Center")
 Abbreviations D-3
 Frequencies 3-52
 Waypoints 5-25
AUTO map scale 3-36, 6-9
Autopilot 6-18

B

Baro set 3-5, 3-55, 6-8
Battery 2-8
Bearing to waypoint 3-31
Brightness, see Display brightness

C

CAL 1 page (Calculator 1) 5-10
CAL 2 page (Calculator 2) 5-11
CAL 3 page (Calculator 3) 5-12
CAL 4 page (Calculator 4) 5-8, 5-12
CAL 5 page (Calculator 5) 5-13
CAL 6 page (Calculator 6) 5-14
CAL 7 page (Calculator 7) 5-15
Canadian Province abbreviations D-1
Cancel, see Delete
Canceling Direct to operations 3-29
Cartridge, see Data base
CDI 3-4, 3-31, 3-59, 4-9, 6-9
CDI scale factor 3-31, 5-37, 5-38, 6-1, 6-2, 6-8
"Center" waypoints 5-25
Changing
 Approaches 6-7
 SIDs 6-24
 STARs 6-24
Communication frequencies
 Airport 3-55
 Center (ARTCC) 3-52
 FSS 3-52
Computer data base, updating 2-3
Controls 3-2, 3-11
Country abbreviations D-1
Course fix 6-6
Course reversal 6-10
Coverage area

- Database 2-1
- Navigation 3-1
- Cross track error 3-32, A-1
- CTA 3-39, 3-42
- CTR 1 page (Center 1) 5-25
- CTR 2 page (Center 2) 5-25
- Cursor 3-11
- Customs 3-48

D

- Database
 - Cartridge 2-3, 2-7
 - Contents 2-1
 - Coverage areas 2-1
 - Currency requirement for approach use 6-1
 - Functions 2-1
 - Operation without cartridge 5-44
 - Page 3-7
 - Update service options 2-8
 - Updating 2-3, 5-46
 - User 2-2, 2-8
- Data entry 3-14
- Date 3-5, 3-53
- Delete
 - Airport remarks 3-47
 - Approach 6-7
 - Direct to operation 3-29
 - Flight plans 4-5
 - SID 6-24
 - STAR 6-24
 - User defined waypoints 5-20
 - Waypoints from a flight plan 4-5
- Departure time 4-13
- Desired track 3-32, 3-34, 4-8, 4-12, A-1
- Direct to operation 3-27, 3-34, 4-10
 - Canceling 3-29
 - Flight plan 4-10
 - Recenter D-Bar 3-28
 - VNAV 5-7
- Display brightness 3-3
- Display format 3-9
- Distance 3-31, 3-36, 4-11, A-1
- D/T 1 page (Distance/Time 1) 5-11
- D/T 2 page (Distance/Time 2) 5-12
- D/T 3 page (Distance/Time 3) 5-12
- D/T 4 page (Distance/Time 4) 5-13
- DME arcs 6-6, 6-16, 6-17, 6-18
- Duplicate waypoints 3-15

E

- Editing
 - SID 6-23
 - STAR 6-23
- EFIS 3-4, 5-34, 6-9
- Enter prompt 3-10
- EPE (estimated position error) 5-30
- Erase, see Delete
- ESA, see minimum enroute safe altitude
- ETA (estimated time of arrival) 4-12, A-1
- ETE (estimated time enroute) 3-31, 3-36, 4-11, A-1

F

- f (final approach fix identifier suffix) 6-7
- FAF (final approach fix) 6-1, 6-2, 6-6
- Fence 6-7
- Flight plan(s)
 - Activating 4-3
 - Active 4-3
 - Adding waypoints 4-4
 - Creating 4-1
 - Deleting flight plans 4-5
 - Deleting waypoints 4-5
 - Inverting 4-3
 - Operation from 4-7
 - Rules 4-1
 - VNAV operation 5-9
- Flashing data on screen 3-11
- Flight time 4-13
- Fly-by/Fly-over waypoints 4-2
- Frequencies, see Communication frequencies
- FSS frequencies 3-52
- Fuel availability 3-48
- Fuel management pages 5-39
- Fuel on board 5-39
- Fuel planning 5-3, 5-5, 5-6

G

- GPS APR switch/annunciator 3-59, 6-1, 6-9
- GPS CRS switch/annunciator 3-7, 3-59, 5-32, 5-33
- GPS status 5-29
- Groundspeed 3-31, 3-36, A-1

H

- h (missed approach holding point identifier suffix) 6-7
- Heading 3-34, A-1
- Height above airport alert 3-58
- Holding pattern 6-11, 6-15, 6-19
- HSI 3-4, 3-59, 4-9, 6-9

I

-i (initial approach fix identifier suffix) 6-7
IAF (initial approach fix) 6-2
 Selecting 6-4, 6-16
ICAO identifiers 2-3
Initialization 3-17
INT page (Intersection page) 3-50
Integrity monitoring, see RAIM
Intercept DME arc 6-16, 6-17
 Moving the intercept point 6-17
Interfaces 1-1
Intermediate fix 6-6
Intersections 3-50
Intersection user waypoints 5-18

J

Jeppesen charts 6-6

K

KA 91 antenna 1-2
KA 92 antenna 1-2

L

Landing fee 3-48
Lighting, runway 3-49
Loading
 Approach 6-4
 SID 6-22
 STAR 6-23
Locator outer marker (LOM) 3-50

M

-m (missed approach point identifier suffix) 6-7
Mach 5-43
Magnetic variation 5-44
Map display 3-34, 3-36
MAP (missed approach point) 3-27, 3-29, 6-2, 6-6, 6-7
MAHP (missed approach holding point) 6-2
Message page 3-16
Messages
 Message page 3-16, Appendix B
 Status line 3-10, Appendix C
Minimum enroute safe altitude (ESA) 3-33, 5-3, 5-5, 5-6, 5-35
Minimum safe altitude (MSA) 3-32
Missed approach procedure 3-27, 6-11, 6-19
MOD pages (MODE) 5-32
Modes 3-10, 3-36, 5-32
MOVE? 6-17

N

NAV 1 page (Navigation 1) 3-31
NAV 2 page (Navigation 2) 3-32
NAV 3 page (Navigation 3) 3-32
NAV 4 page (Navigation 4) 3-34, 5-7
NAV 5 page (Navigation 5) 3-34
NAV/GPS switch/annunciator 3-59, 6-1
Navigation map display 3-34, 3-35
Navigation terms A-1
NDB page 3-49
NDB user waypoints 5-18
NDBs, nearest 3-22, 3-37
NDBs, on map display 3-37
Nearest airports, VORs, NDBs 3-22
NOS charts 6-6
NO WPT SEQ 6-7
Non-precision approaches, see Approaches

O

OBS IN 3-4
OBS mode 3-32, 4-9, 5-34
 In approach procedures 6-10, 6-11, 6-12, 6-14, 6-19
OBS OUT 3-4
OBS warning page 3-7
Off-airport navaid 6-10
On-airport navaid 6-14
ORS (Operational Revision Status) 3-3
OTH 1 page (Other 1) 3-52
OTH 2 page (Other 2) 3-52
OTH 3 page (Other 3) 5-20
OTH 4 page (Other 4) 3-47
OTH 5 page (Other 5) 5-39
OTH 6 page (Other 6) 5-41
OTH 7 page (Other 7) 5-41
OTH 8 page (Other 8) 5-41
OTH 9 page (Other 9) 5-43
OTH 10 page (Other 10) 5-43
Outer markers (OM) 4-50
Oxygen availability 3-48

P

Page definition 3-9
Page selection 3-12
Plus sign (+) meaning 3-9
Power cycles 5-31
Present position 3-8, 3-32
Preview of Operation II
Procedure turns 6-14

R

RAIM (receiver autonomous integrity monitoring) 6-3, 6-14, 6-15, 6-18
 Prediction 6-19, 6-20
Radar vectors 6-12, 6-17
Receiver status 5-29
REF page (Reference waypoint) 5-21
Reference waypoints 5-21
Removing KLN 90B 2-7
Runway fix 6-6
Runway information 3-43

S

Sample trips 3-60, 4-15
Satellite status 5-29
Scanning active waypoints 3-37, 6-17
Scanning waypoints 3-21, 3-24
Selected course, see OBS mode
Selecting
 Approach 6-4
 IAF 6-2
 SID 6-22
 STAR 6-23
 Transition (SID/STAR) 6-22
 Waypoints 3-20
Self test page 3-3
SET 0 page (Setup 0) 2-4
SET 1 page (Setup 1) 3-17, 5-46
SET 2 page (Setup 2) 3-53
SET 3 page (Setup 3) 3-22
SET 4 page (Setup 4) 4-13
SET 5 page (Setup 5) 3-58
SET 6 page (Setup 6) 4-9
SET 7 page (Setup 7) 3-39, 5-10
SET 8 page (Setup 8) 3-41
SET 9 page (Setup 9) 3-57, 3-59
SID (standard instrument departure)
 Changing 6-24
 Deleting 6-24
 Editing 6-23
 Example 6-25
 Loading 6-22
 Selecting 6-22
SID/STARs 2-2, 3-49, 4-2, 5-45, 6-21
SNR (Signal-to-Noise Ratio) 5-29
Software status 5-31
Special use airspace 3-39, 5-3, 5-5, 5-6
STA 1 page (Status 1) 5-29
STA 2 page (Status 2) 5-30
STA 3 page (Status 3) 5-31
STA 4 page (Status 4) 5-31
STAR (standard terminal arrival route)
 Changing 6-24

 Deleting 6-24
 Editing 6-23
 Example 6-26
 Loading 6-23
 Selecting 6-23
State abbreviations D-1
Status line messages 3-10, Appendix C
Step-down fix 6-9, 6-18
Sunrise/Sunset 5-15
SUP page (Supplemental waypoint) 5-18
Super NAV 1 page 3-32
Super NAV 5 page 3-27, 3-37, 5-9, 5-35, 6-1, 6-6, 6-17
Supplemental waypoints 3-51, 5-18
Surface, runway 3-44
System components 1-1

T

Take-home mode 3-3, 3-19, 5-46
Temperature conversion 5-13
Terminal waypoints 4-10
 Names 6-5
Time
 Actual 3-5, 3-53, 4-13
 Enroute 3-31, 3-36, 4-11, 4-13
 Flight 4-13
 Of arrival 4-12, 4-13
 Total time of operation 5-31
 Zones 3-5, 5-14
Time to first fix 3-17
TMA 3-39, 3-42
Track, see Actual track, see Desired track
Traffic pattern indicator 3-44
Transitions (SID/STAR), selecting 6-22
TRI 0 page (Trip Planning 0) 5-2
TRI 1 page (Trip Planning 1) 5-3
TRI 2 page (Trip Planning 2) 5-3
TRI 3 page (Trip Planning 3) 5-5
TRI 4 page (Trip Planning 4) 5-5
TRI 5 page (Trip Planning 5) 5-6
TRI 6 page (Trip Planning 6) 5-6
Trip planning 5-1
True airspeed 5-11, 5-43
Turn anticipation 4-8
Turn-on 3-3
Turn-on page 3-3, 5-28

U

Updating database 2-3, 5-46
User database 2-2, 2-8, 3-51
User-defined waypoints 5-16
UTC, see Time Zones

V

VNAV (vertical navigation) 3-36, 5-7

Vectors 6-12, 6-17

VOR(s)

page 3-49

user waypoint 5-18

nearest 3-22, 3-37

on map display 3-37

W

Waypoint alerting 3-29, 4-8

Waypoint scanning window 3-37, 6-17

Waypoints

Active 3-31

“Center” 5-25

Duplicate 3-15

Identifiers 2-3

Nearest 3-22

Reference 5-21

Selecting by identifier 3-20

Selecting by name or city 3-24

Selecting by scanning 3-21

User defined 2-2, 5-16

Wind 5-12, 5-43

X

Y

Z

THIS PAGE INTENTIONALLY LEFT BLANK